



LaserJet Enterprise MFP M631, M632, M633

User Guide



M631dn
Flow M631h
M632h
M633fh

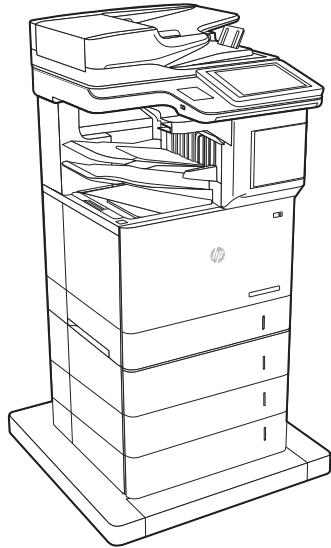

M631z

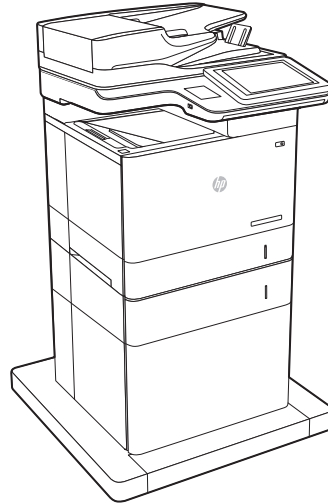

M632fht

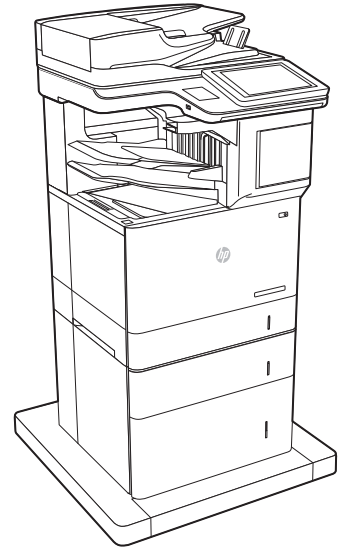

Flow M632z
Flow M633z



www.hp.com/support/ljM631MFP
www.hp.com/support/ljM632MFP
www.hp.com/support/ljM633MFP



HP LaserJet Enterprise MFP M631, M632, M633

User Guide

Copyright and License

© Copyright 2017 HP Development Company, L.P.

Reproduction, adaptation, or translation without prior written permission is prohibited, except as allowed under the copyright laws.

The information contained herein is subject to change without notice.

The only warranties for HP products and services are set forth in the express warranty statements accompanying such products and services. Nothing herein should be construed as constituting an additional warranty. HP shall not be liable for technical or editorial errors or omissions contained herein.

Edition 3, 10/2017

Trademark Credits

Adobe®, Adobe Photoshop®, Acrobat®, and PostScript® are trademarks of Adobe Systems Incorporated.

Apple and the Apple logo are trademarks of Apple Inc., registered in the U.S. and other countries.

OS X is a trademark of Apple Inc., registered in the U.S. and other countries.

AirPrint is a trademark of Apple Inc., registered in the U.S. and other countries.

Google™ is a trademark of Google Inc.

Microsoft®, Windows®, Windows® XP, and Windows Vista® are U.S. registered trademarks of Microsoft Corporation.

UNIX® is a registered trademark of The Open Group.

Table of contents

1 Printer overview	1
Printer views	2
Printer front view	2
Printer back view	4
Interface ports	5
Control-panel view	5
How to use the touchscreen control panel	8
Printer specifications	9
Technical specifications	9
Supported operating systems	11
Mobile printing solutions	13
Printer dimensions	14
Power consumption, electrical specifications, and acoustic emissions	17
Operating environment range	17
Printer hardware setup and software installation	18
2 Paper trays	19
Introduction	20
Load paper to Tray 1 (multipurpose tray)	21
Tray 1 paper orientation	22
Use alternative letterhead mode	25
Enable Alternative Letterhead Mode by using the printer control-panel menus	25
Load Tray 2 and the 550-sheet trays	26
Introduction	26
Tray 2 and the 550-sheet trays paper orientation	27
Use alternative letterhead mode	29
Enable Alternative Letterhead Mode by using the printer control-panel menus	29
Load the 2,100-sheet high-capacity input tray	30
Load and print envelopes	32
Introduction	32
Print envelopes	32
Envelope orientation	33

Load and print labels	34
Introduction	34
Manually feed labels	34
Label orientation	35
Configure the stapling mailbox accessory	36
Configure the default staple location	36
Configure the operation mode	37

3 Supplies, accessories, and parts 39

Order supplies, accessories, and parts	40
Ordering	40
Supplies and accessories	40
Maintenance/long-life consumables	41
Customer self-repair parts	41
Configure the HP toner-cartridge-protection supply settings	43
Introduction	43
Enable or disable the Cartridge Policy feature	43
Use the printer control panel to enable the Cartridge Policy feature	43
Use the printer control panel to disable the Cartridge Policy feature	43
Use the HP Embedded Web Server (EWS) to enable the Cartridge Policy feature	44
Use the HP Embedded Web Server (EWS) to disable the Cartridge Policy feature	44
Troubleshoot Cartridge Policy control panel error messages	45
Enable or disable the Cartridge Protection feature	45
Use the printer control panel to enable the Cartridge Protection feature	45
Use the printer control panel to disable the Cartridge Protection feature	45
Use the HP Embedded Web Server (EWS) to enable the Cartridge Protection feature	45
Use the HP Embedded Web Server (EWS) to disable the Cartridge Protection feature	46
Troubleshoot Cartridge Protection control panel error messages	46
Replace the toner cartridge	47
Replace the staple cartridge	51

4 Print 53

Print tasks (Windows)	54
How to print (Windows)	54
Automatically print on both sides (Windows)	56
Manually print on both sides (Windows)	56
Print multiple pages per sheet (Windows)	57
Select the paper type (Windows)	57
Additional print tasks	58
Print tasks (OS X)	59
How to print (OS X)	59

Automatically print on both sides (OS X)	59
Manually print on both sides (OS X)	59
Print multiple pages per sheet (OS X)	60
Select the paper type (OS X)	60
Additional print tasks	60
Store print jobs on the printer to print later or print privately	62
Introduction	62
Create a stored job (Windows)	62
Create a stored job (OS X)	64
Print a stored job	64
Delete a stored job	65
Information sent to printer for Job Accounting purposes	65
Mobile printing	66
Introduction	66
Wireless Direct Print and NFC Printing	66
HP ePrint via email	67
HP ePrint software	67
AirPrint	68
Android embedded printing	68
Print from the USB port	70
Introduction	70
Enable the USB port for printing	70
Print USB documents	71
5 Copy	73
Make a copy	74
Copy on both sides (duplex)	76
Additional options when copying	78
Additional copy tasks	80
6 Scan	81
Set up Scan to Email	82
Introduction	82
Before you begin	82
Step one: Access the HP Embedded Web Server (EWS)	82
Step two: Configure the Network Identification settings	83
Step three: Configure the Send to Email feature	84
Method one: Basic configuration using the Email Setup Wizard	84
Method two: Advanced configuration using the Email Setup	88
Step four: Configure the Quick Sets (optional)	92
Step five: Set up Send to Email to use Office 365 Outlook (optional)	93

Introduction	93
Configure the outgoing email server (SMTP) to send an email from an Office 365 Outlook account	93
Set up Scan to Network Folder	95
Introduction	95
Before you begin	95
Step one: Access the HP Embedded Web Server	95
Step two: Set up Scan to Network Folder	96
Method one: Use the Scan to Network Folder Wizard	96
Method two: Use Scan to Network Folder Setup	97
Step one: Begin the configuration	97
Step two: Configure the Scan to Network Folder settings	98
Step three: Complete the configuration	105
Set up Scan to USB Drive	106
Introduction	106
Step one: Access the HP Embedded Web Server	106
Step two: Enable Scan to USB Drive	107
Step three: Configure the Quick Sets (optional)	107
Default scan settings for Scan to USB Drive setup	108
Default file settings for Save to USB Setup	108
Set up Save to SharePoint® (Flow models only)	110
Introduction	110
Before you begin	110
Step one: Access the HP Embedded Web Server (EWS)	110
Step two: Enable Save to SharePoint® and create a Save to SharePoint Quick Set	111
Scan and save a file directly to a Microsoft® SharePoint site	113
Quick set scan settings and options for Save to SharePoint®	114
Create a Quick Set	116
Introduction	116
Step one: Access the HP Embedded Web Server (EWS)	116
Step two: Add and manage Quick Sets	117
Add a Quick Set	117
Edit a Quick Set	118
Copy a Quick Set	118
Remove a Quick Set	119
Quick Set settings and options	119
Send a scanned document to one or more email addresses	125
Introduction	125
Scan and send a document to email	125
Scan and send to network folder	127
Introduction	127

Scan and save the document to a folder	127
Scan and send to USB Flash Drive	129
Introduction	129
Scan and save the document to a USB flash drive	129
Additional options when scanning	131
HP JetAdvantage business solutions	133
Additional scan tasks	134
7 Fax	135
Set up fax	136
Introduction	136
Set up fax by using the printer control panel	136
Change fax configurations	137
Fax dialing settings	137
General fax send settings	138
Fax receive settings	138
Send a fax	140
Additional options when faxing	142
Additional fax tasks	143
8 Manage the printer	145
Advanced configuration with HP Embedded Web Server (EWS)	146
Introduction	146
How to access the HP Embedded Web Server (EWS)	146
HP Embedded Web Server features	147
Information tab	147
General tab	148
Copy/Print tab	149
Scan/Digital Send tab	150
Fax tab	151
Troubleshooting tab	151
Security tab	152
HP Web Services tab	152
Networking tab	152
Other Links list	154
Configure IP network settings	155
Printer sharing disclaimer	155
View or change network settings	155
Rename the printer on a network	155
Manually configure IPv4 TCP/IP parameters from the control panel	156
Manually configure IPv6 TCP/IP parameters from the control panel	156

Link speed and duplex settings	157
Printer security features	158
Introduction	158
Security statements	158
Assign an administrator password	158
IP Security	159
Lock the formatter	159
Encryption support: HP High Performance Secure Hard Disks	159
Energy-conservation settings	160
Introduction	160
Print with EconoMode	160
Set the sleep timer and configure the printer to use 1 watt or less of power	160
Set the sleep schedule	161
HP Web Jetadmin	162
Software and firmware updates	163

9 Solve problems 165

Customer support	166
Control panel help system	167
Restore factory settings	168
Introduction	168
Method one: Restore factory settings from the printer control panel	168
Method two: Restore factory settings from the HP Embedded Web Server (network-connected printers only)	168
A “Cartridge is low” or “Cartridge is very low” message displays on the printer control panel	169
Change the “Very Low” settings	169
For printers with fax capability	169
Order supplies	170
Printer does not pick up paper or misfeeds	171
Introduction	171
The printer does not pick up paper	171
The printer picks up multiple sheets of paper	173
The document feeder jams, skews, or picks up multiple sheets of paper	177
Clear paper jams	178
Introduction	178
Paper jam locations	179
Auto-navigation for clearing paper jams	180
Experiencing frequent or recurring paper jams?	180
Clear paper jams in the document feeder	181
Clear paper jams in Tray 1	183
Clear paper jams in Trays 2, 3, 4, or 5	185

Clear paper jams in the 2,100-sheet high-capacity input tray	188
Clear paper jams in the right door and fuser area	192
Clear paper jams in the output bin	195
Clear paper jams in the duplexer	195
Clear paper jams in the envelope feeder	196
Clear paper jams in the HP Stapling Mailbox	198
Clear staple jams	200
Improve print quality	203
Introduction	203
Print from a different software program	203
Check the paper-type setting for the print job	203
Check the paper type setting (Windows)	203
Check the paper type setting (OS X)	204
Check toner-cartridge status	204
Print a cleaning page	204
Visually inspect the toner cartridge	205
Check paper and the printing environment	205
Step one: Use paper that meets HP specifications	205
Step two: Check the environment	205
Step three: Set the individual tray alignment	206
Try a different print driver	206
Check the EconoMode settings	207
Adjust print density	207
Image defects table	209
Improve copy image quality	216
Check the scanner glass for dirt and smudges	216
Calibrate the scanner	217
Check the paper settings	218
Check the paper size and type configuration	218
Select the tray to use for the copy	218
Check the image-adjustment settings	218
Optimize copy quality for text or pictures	219
Edge-to-edge copying	219
Improve scan image quality	220
Check the scanner glass for dirt and smudges	220
Check the resolution settings	221
Check the image-adjustment settings	222
Optimize scan quality for text or pictures	222
Check the output-quality settings	223
Improve fax image quality	224
Check the scanner glass for dirt and smudges	224

Check the send-fax resolution settings	225
Check the image-adjustment settings	226
Optimize fax quality for text or pictures	226
Check the error-correction settings	226
Check the fit-to-page setting	227
Send to a different fax machine	227
Check the sender's fax machine	227
Solve wired network problems	228
Introduction	228
Poor physical connection	228
The computer is using the incorrect IP address for the printer	228
The computer is unable to communicate with the printer	229
The printer is using incorrect link and duplex settings for the network	229
New software programs might be causing compatibility problems	229
The computer or workstation might be set up incorrectly	229
The printer is disabled, or other network settings are incorrect	229
Solve wireless network problems	230
Introduction	230
Wireless connectivity checklist	230
The printer does not print after the wireless configuration completes	231
The printer does not print, and the computer has a third-party firewall installed	231
The wireless connection does not work after moving the wireless router or printer	231
Cannot connect more computers to the wireless printer	231
The wireless printer loses communication when connected to a VPN	232
The network does not appear in the wireless networks list	232
The wireless network is not functioning	232
Reduce interference on a wireless network	232
Solve fax problems	233
Checklist for solving fax problems	233
What type of phone line are you using?	233
Are you using a surge-protection device?	233
Are you using a phone company voice-messaging service or an answering machine?	233
Does your phone line have a call-waiting feature?	234
Check fax accessory status	234
General fax problems	235
The fax failed to send	235
An Out of Memory status message displays on the printer control panel	235
Print quality of a photo is poor or prints as a gray box	235
You touched the Stop button to cancel a fax, but the fax was still sent	235
No fax address book button displays	235
Not able to locate the Fax settings in HP Web Jetadmin	235

The header is appended to the top of the page when the overlay option is enabled 235
A mix of names and numbers is in the recipients box 235
A one-page fax prints as two pages 235
A document stops in the document feeder in the middle of faxing 236
The volume for sounds coming from the fax accessory is too high or too low 236

Index 237

1 Printer overview

- [Printer views](#)
- [Printer specifications](#)
- [Printer hardware setup and software installation](#)

For more information:

The following information is correct at the time of publication. For current information, see www.hp.com/support/ljM631MFP, www.hp.com/support/ljM632MFP, or www.hp.com/support/ljM633MFP.

HP's all-inclusive help for the printer includes the following information:

- Install and configure
- Learn and use
- Solve problems
- Download software and firmware updates
- Join support forums
- Find warranty and regulatory information

Printer views

- [Printer front view](#)
- [Printer back view](#)
- [Interface ports](#)
- [Control-panel view](#)

Printer front view

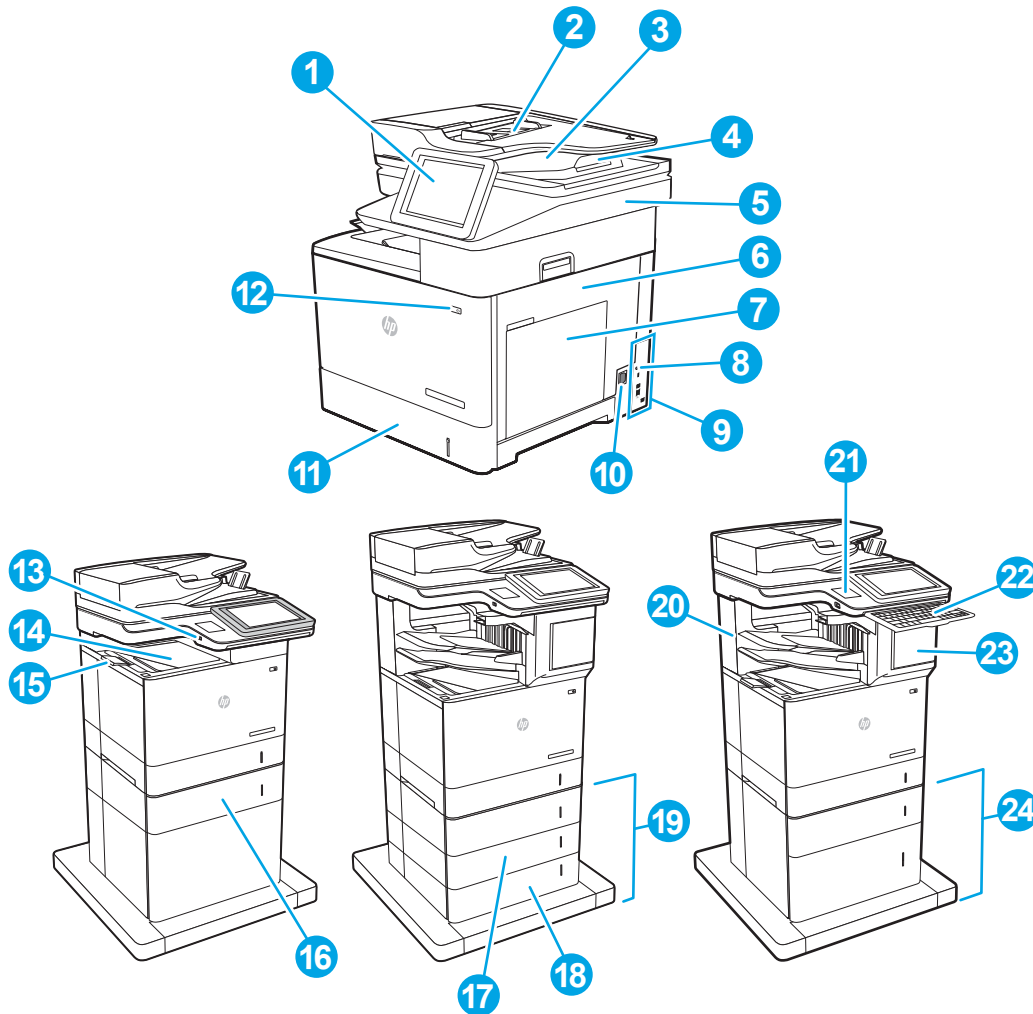

1	Control panel with color touchscreen display (tilts up for easier viewing)
2	Document-feeder input tray
3	Document-feeder output bin
4	Document-feeder output extension (extend this when scanning longer—such as legal—paper)
5	Scanner assembly

6	Right door (access for clearing jams)
7	Tray 1 (multipurpose tray)
8	Formatter (contains the interface ports)
9	Slot for a cable-type security lock
10	Power connection
11	Tray 2
12	On/off button
13	Walk-up USB port
14	Output bin
15	Output bin extension
16	Tray 3
17	Tray 4
18	Tray 5
19	3x550-sheet tray (included with the M631z; optional for the M631dn, M631h, M632h, and M633fh)
20	HP Stapling Mailbox (included with the M631z, M632z, and M633z)
21	Hardware integration pocket (for connecting accessories and third-party devices)
22	Keyboard (M632z and M633z only. Pull the keyboard straight out to use it.)
	CAUTION: Close the keyboard when it is not in use.
23	Stapler door (included with the M631z, M632z, and M633z)
24	1x550-sheet tray and 2,100-sheet high-capacity input tray (included with the M632z and M633z; optional for the M631dn, M631h, M632h, and M633fh)

Printer back view

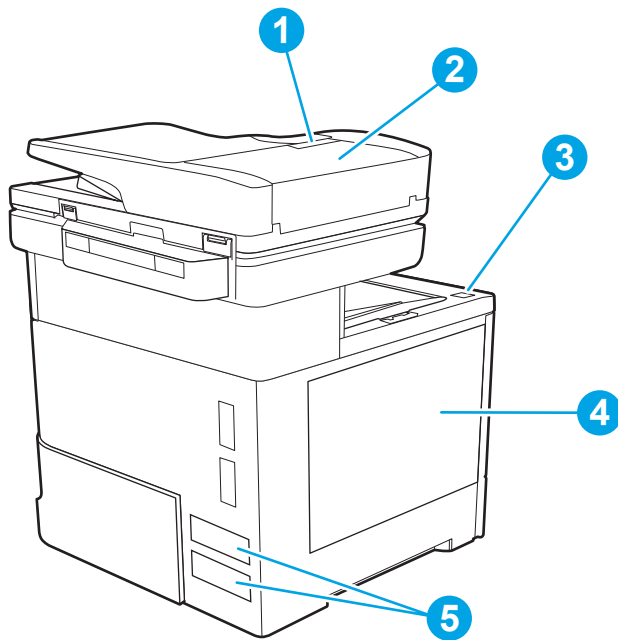

-
- | | |
|---|--|
| 1 | Document feeder cover release latch |
| 2 | Document-feeder cover (access for clearing jams) |
| 3 | Cartridge door release button |
| 4 | Cartridge door (access to the toner cartridge) |
| 5 | Serial number and product number label |
-

Interface ports

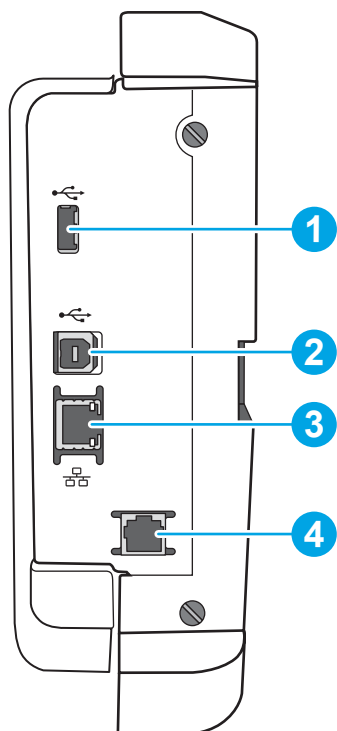

-
- | | |
|---|--|
| 1 | Host USB port for connecting external USB devices (this port might be covered) |
|---|--|

NOTE: For easy-access USB printing, use the USB port near the control panel.

-
- | | |
|---|--|
| 2 | Hi-Speed USB 2.0 printing port |
| 3 | Local area network (LAN) Ethernet (RJ-45) network port |
| 4 | Fax port (fax models only) |
-



Control-panel view

The Home screen provides access to the printer features and indicates the current status of the printer.

Return to the Home screen at any time by touching the Home button on the left side of the printer control panel, or touch the Home button in the upper-left corner of most screens.

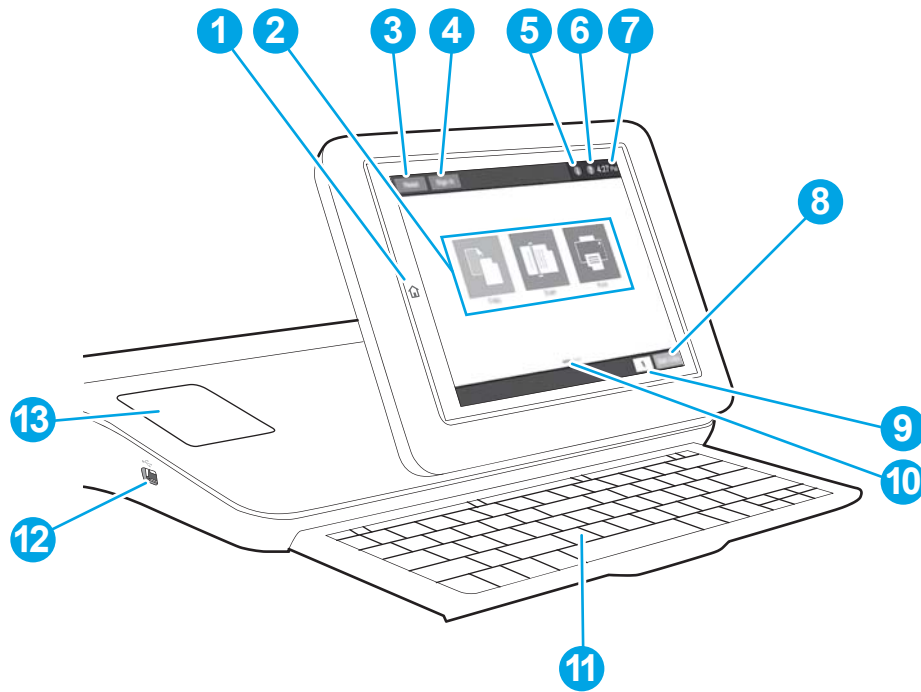
 **NOTE:** The features that appear on the Home screen can vary, depending on the printer configuration.



1	Home  button	Touch the Home button to return to the Home screen.
2	Applications area	Touch any of the icons to open the application. Swipe the screen sideways to access more applications. NOTE: The available applications vary by printer. The administrator can configure which applications appear and the order in which they appear.
3	Reset button	Touch the Reset button to clear changes, release the printer from a paused state, reset the copy count field, display hidden errors, and restore the default settings (including the language and keyboard layout).
4	Sign In or Sign Out button	Touch the Sign In button to access secured features. Touch the Sign Out button to sign out of the printer. The printer restores all options to the default settings. NOTE: This button displays only if the administrator has configured the printer to require permission for access to features.
5	Information  button	Touch the information button to access a screen that provides access to several types of printer information. Touch the buttons at the bottom of the screen for the following information: <ul style="list-style-type: none"> • Display Language: Change the language setting for the current user session. • Sleep Mode: Place the printer into sleep mode. • Wi-Fi Direct: View information for how to connect directly to the printer using a phone, tablet, or other device with Wi-Fi. • Wireless: View or change wireless connection settings (for the z model and for the dn and f models only when an optional wireless accessory is installed). • Ethernet: View or change Ethernet connection settings. • HP Web Services: View information to connect and print to the printer using HP Web Services (ePrint). • Fax Number: View the printer fax number (fax models only).

6	Help  button	Touch the Help button to open the embedded help system.
7	Current time	Displays the current time.
8	Start Copy button	Touch the Start Copy button to start a copy job.
9	Copy count	The copy count indicates the number of copies that the printer is set to make.
10	Home-screen page indicator	Indicates the number of pages on the Home screen or in an application. The current page is highlighted. Swipe the screen sideways to scroll between pages.
11	Keyboard (Flow models only)	<p>Flow models include a physical keyboard. The keys are mapped to a language in the same way the virtual keyboard on the printer touchscreen is mapped. Whenever the keyboard layout for the virtual keyboard changes, the keys on the physical keyboard are remapped to match the new settings.</p> <p>NOTE: In some locations, the printer comes with adhesive keyboard overlays to customize the keys for different languages.</p>
12	Easy-access USB port	<p>Insert a USB flash drive for printing or scanning without a computer or to update the printer firmware.</p> <p>NOTE: An administrator must enable this port before use.</p>
13	Hardware integration pocket (HIP)	For connecting accessory and third-party devices.

How to use the touchscreen control panel

Use the following actions to use the printer touchscreen control panel.

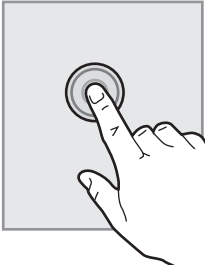
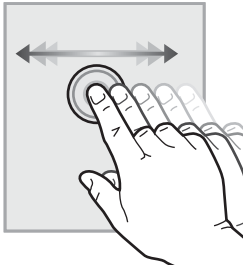
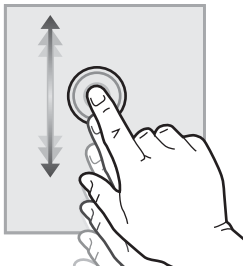
Action	Description	Example
Touch 	Touch an item on the screen to select that item or open that menu. Also, when scrolling through menus, briefly touch the screen to stop the scrolling.	Touch the Settings icon to open the Settings app.
Swipe 	Touch the screen and then move your finger horizontally to scroll the screen sideways.	Swipe until the Settings app displays.
Scroll 	Touch the screen and then move your finger vertically to scroll the screen up and down. When scrolling through menus, briefly touch the screen to stop the scrolling.	Scroll through the Settings app.

Printer specifications

 **IMPORTANT:** The following specifications are correct at the time of publication, but they are subject to change. For current information, see www.hp.com/support/ljM631MFP, www.hp.com/support/ljM632MFP, or www.hp.com/support/ljM633MFP.

- [Technical specifications](#)
- [Supported operating systems](#)
- [Mobile printing solutions](#)
- [Printer dimensions](#)
- [Power consumption, electrical specifications, and acoustic emissions](#)
- [Operating environment range](#)

Technical specifications

Model name		M631dn, M632h	M631h, M632fht, M633fh	M631z, M632z, M633z
Product number		J8J63A, J8J70A	J8J64A, J8J71A, J8J76A	J8J65A, J8J72A, J8J78A
Paper handling	Tray 1 (100-sheet capacity)	✓	✓	✓
	Tray 2 (550-sheet capacity)	✓	✓	✓
	1x550-sheet paper feeder	Optional	Optional	Optional (not available for M631z)
	NOTE: The printer supports as many as six input trays.			
	1x550-sheet feeder plus 2,100-sheet high-capacity feeder	Optional	Optional	Included with the M632z and M633z
	Automatic duplex printing	✓	✓	✓
	Envelope feeder cassette for printing up to 75 envelopes	Optional	Optional	Optional
	HP Stapling Mailbox	Not supported	Not supported	✓
Connectivity	10/100/1000 Ethernet LAN connection with IPv4 and IPv6	✓	✓	✓
	Hi-Speed USB 2.0	✓	✓	✓
	Easy-access USB port for printing and scanning without a computer and upgrading the firmware	✓	✓	✓
	Hardware integration pocket (HIP) for connecting accessories and third-party devices	✓	✓	✓
	HP Internal USB ports	Optional	Optional	Optional
	HP Jetdirect 3000w NFC/Wireless Accessory for printing from mobile devices	Optional	Optional	Optional

Model name		M631dn, M632h	M631h, M632fht, M633fh	M631z, M632z, M633z
Product number		J8J63A, J8J70A	J8J64A, J8J71A, J8J76A	J8J65A, J8J72A, J8J78A
	Integrated HP Wi-Fi Direct accessory for printing from mobile devices	Not supported	Not supported	M631z and M633z
	HP Jetdirect 2900nw Print Server Accessory for wireless connectivity	Optional	Optional	Optional
Internal Storage	16 GB eMMC hard drive	M631dn	Not supported	Not supported
	320 GB HP High-Performance Secure Hard Disk	Included with the M632h; optional for the M631dn	✓	✓
Memory	1.75 GB base memory, expandable to 2.5 GB	✓	✓	Not supported
	2.25 GB base memory, expandable to 3 GB	Not supported	Not supported	✓
Security	HP Trusted Platform Module for encrypting all data that passes through the printer	Optional	Optional	Optional
Control-panel display and input	Touchscreen control panel	✓	✓	✓
	Retractable keyboard	Not supported	Not supported	✓
Print	Prints 52 pages per minute (ppm) on A4 and 55 ppm on letter-size paper	M631dn	M631h	M631z
	Prints 61 ppm on A4 and 65 ppm on letter-size paper	M632h	M632fht	M632z
	Prints 71 ppm on A4 and 75 ppm on letter-size paper	Not supported	M633fh	M633z
	Easy-access USB printing (no computer required)	✓	✓	✓
Fax		Optional	Included with M632fht, M633fh; optional for the M631h	✓
Copy and scan	Copies 52 pages per minute (ppm) on A4 and 55 ppm on letter-size paper	M631dn	M631h	M631z
	NOTE: Copy and scan speeds are subject to change. For the most current information, go to www.hp.com/support/ljM631MFP , www.hp.com/support/ljM632MFP , or www.hp.com/support/ljM633MFP			
	Copies 61 ppm on A4 and 65 ppm on letter-size paper	M632h	M632fht	M632z
	Copies 71 ppm on A4 and 75 ppm on letter-size paper		M633fh	M633z

Model name	M631dn, M632h	M631h, M632fht, M633fh	M631z, M632z, M633z
Product number	J8J63A, J8J70A	J8J64A, J8J71A, J8J76A	J8J65A, J8J72A, J8J78A
Scans at 75 images per minute (ipm) (monochrome or color).	✓	✓	
Scans at 120 ipm (monochrome and color).			✓
Easy-access USB copying and scanning (no computer required)	✓	✓	✓
150-page document feeder with electronic duplex copying and scanning	✓	✓	✓
HP EveryPage Technologies including ultrasonic multi-feed detection	Not supported	Not supported	✓
Embedded optical character recognition (OCR) provides the ability to convert printed pages into text that can be edited or searched using a computer.	Not supported	Not supported	✓
SMART Label feature provides paper-edge detection for automatic page cropping	Not supported	Not supported	✓
Automatic page orientation for pages that have at least 100 characters of text.	Not supported	Not supported	✓
Automatic tone adjustment sets contrast, brightness, and background removal for each page.	Not supported	Not supported	✓
Digital Send			
Send to E-mail , Save to USB , and Save to Network Folder	✓	✓	✓
Send documents to SharePoint®	Not supported	Not supported	✓

Supported operating systems

The following information applies to the printer-specific Windows PCL 6 and HP print drivers for OS X and to the software installer.

Windows: The HP Software Installer installs the “HP PCL.6” version 3 print driver, the “HP PCL 6” version 3 print driver, or the “HP PCL-6” version 4 print driver, depending on the Windows operating system, along with optional software when using the software installer. Download the “HP PCL.6” version 3 print driver, the “HP PCL 6” version 3 print driver, and the “HP PCL-6” version 4 print driver from the printer-support website for this printer: www.hp.com/support/ljM631MFP, www.hp.com/support/ljM632MFP, or www.hp.com/support/ljM633MFP.

OS X: Mac computers are supported with this printer. Download HP Easy Start either from 123.hp.com/LaserJet or from the Printer Support page, and then use HP Easy Start to install the HP print driver. HP Easy Start is not included in the HP Software Installer.

1. Go to 123.hp.com/LaserJet.
2. Follow the steps provided to download the printer software.

Linux: For information and print drivers for Linux, go to www.hp.com/go/linuxprinting.

UNIX: For information and print drivers for UNIX®, go to www.hp.com/go/unixmodelscripts.

Table 1-1 Supported operating systems and print drivers

Operating system	Print driver (for Windows, or the installer on the web for OS X)	Notes
Windows® XP SP3, 32-bit	The “HP PCL.6” printer-specific print driver is installed for this operating system as part of the software installation.	Microsoft retired mainstream support for Windows XP in April 2009. HP will continue to provide best effort support for the discontinued XP operating system. Some features of the print driver are not supported.
Windows Vista®, 32-bit	The “HP PCL.6” printer-specific print driver is installed for this operating system as part of the software installation.	Microsoft retired mainstream support for Windows Vista in April 2012. HP will continue to provide best effort support for the discontinued Vista operating system. Some features of the print driver are not supported.
Windows Server 2003 SP2, 32-bit	The “HP PCL.6” printer-specific print driver is available for download from the printer-support website. Download the driver, and then use the Microsoft Add Printer tool to install it.	Microsoft retired mainstream support for Windows Server 2003 in July 2010. HP will continue to provide best effort support for the discontinued Server 2003 operating system. Some features of the print driver are not supported.
Windows 7, 32-bit and 64-bit	The “HP PCL 6” printer-specific print driver is installed for this operating system as part of the software installation.	
Windows 8, 32-bit and 64-bit	The “HP PCL 6” printer-specific print driver is installed for this operating system as part of the software installation.	Windows 8 RT support is provided through Microsoft IN OS Version 4, 32- bit driver.
Windows 8.1, 32-bit and 64-bit	The “HP PCL-6” V4 printer-specific print driver is installed for this operating system as part of the software installation.	Windows 8.1 RT support is provided through Microsoft IN OS Version 4, 32- bit driver.
Windows 10, 32-bit and 64-bit	The “HP PCL-6” V4 printer-specific print driver is installed for this operating system as part of the software installation.	
Windows Server 2008 SP2, 32-bit	The “HP PCL.6” printer-specific print driver is available for download from the printer-support website. Download the driver, and then use the Microsoft Add Printer tool to install it.	Microsoft retired mainstream support for Windows Server 2008 in January 2015. HP will continue to provide best effort support for the discontinued Server 2008 operating system. Some features of the print driver are not supported.
Windows Server 2008 SP2, 64-bit	The “HP PCL 6” printer-specific print driver is available for download from the printer-support website. Download the driver, and then use the Microsoft Add Printer tool to install it.	Microsoft retired mainstream support for Windows Server 2008 in January 2015. HP will continue to provide best effort support for the discontinued Server 2008 operating system.

Table 1-1 Supported operating systems and print drivers (continued)

Operating system	Print driver (for Windows, or the installer on the web for OS X)	Notes
Windows Server 2008 R2, SP 1, 64-bit	The "HP PCL 6" printer-specific print driver is available for download from the printer-support website. Download the driver, and then use the Microsoft Add Printer tool to install it.	
Windows Server 2012, 64-bit	The PCL 6 printer-specific print driver is available for download from the printer-support website. Download the driver, and then use the Microsoft Add Printer tool to install it.	
Windows Server 2012 R2, 64-bit	The PCL 6 printer-specific print driver is available for download from the printer-support website. Download the driver, and then use the Microsoft Add Printer tool to install it.	
OS X 10.10 Yosemite, OS X 10.11 El Capitan, OS X 10.12 Sierra	The HP print driver is available for download from 123.hp.com/LaserJet . The HP installer software for OS X is not included in the HP Software Installer.	For OS X, download the installer from 123.hp.com/LaserJet . <ol style="list-style-type: none"> 1. Go to 123.hp.com/LaserJet. 2. Follow the steps provided to download the printer software.

 **NOTE:** For a current list of supported operating systems, go to www.hp.com/support/ljM631MFP, www.hp.com/support/ljM632MFP, or www.hp.com/support/ljM633MFP for HP's all-inclusive help for the printer.



 **NOTE:** For details on client and server operating systems and for HP UPD driver support for this printer, go to www.hp.com/go/upd. Under **Additional information**, click the links.

Table 1-2 Minimum system requirements

Windows	OS X
<ul style="list-style-type: none"> • CD-ROM drive, DVD drive, or an Internet connection • Dedicated USB 1.1 or 2.0 connection or a network connection • 400 MB of available hard-disk space • 1 GB RAM (32-bit) or 2 GB RAM (64-bit) 	<ul style="list-style-type: none"> • Internet connection • 1 GB of available hard-disk space

Mobile printing solutions

HP offers multiple mobile and ePrint solutions to enable easy printing to an HP printer from a laptop, tablet, smartphone, or other mobile device. To see the full list and to determine the best choice, go to www.hp.com/go/LaserJetMobilePrinting.

 **NOTE:** Update the printer firmware to ensure all mobile printing and ePrint capabilities are supported.

- Wi-Fi Direct (wireless models only)
- HP ePrint via email (Requires HP Web Services to be enabled and the printer to be registered with HP Connected)
- HP ePrint app (Available for Android, iOS, and Blackberry)
- HP All-in-One Remote app for iOS and Android devices
- HP ePrint software
- Google Cloud Print
- AirPrint
- Android Printing

Printer dimensions

Table 1-3 Dimensions for base models (M631dn, M631h Flow, M632h, M633fh)

	Printer fully closed	Printer fully opened
Height	640 mm (25.2 in)	865 mm (34.1 in)
Depth	558 mm (22 in)	805 mm (31.7 in)
Width	512 mm (20.15 in)	1,030 mm (40.5 in)
Weight (with toner cartridge)	33.2 kg (73.2 lb)	

Table 1-4 Dimensions for M631z

	Printer fully closed	Printer fully opened
Height	1,234 mm (48.6 in)	1,500 mm (59.1 in)
Depth	658 mm (25.9 in)	890 mm (35 in)
Width	661 mm (26 in)	1,030 mm (40.5 in)
Weight (with toner cartridge)	62.5 kg (137.8 lb)	

Table 1-5 Dimensions for M632fht

	Printer fully closed	Printer fully opened
Height	1,094 mm (43.2 in)	1,365 mm (53.7 in)
Depth	600 mm (26 in)	890 mm (35 in)
Width	665 mm (26.15 in)	1,030 mm (40.5 in)
Weight (with toner cartridge)	52.5 kg (115.8 lb)	

Table 1-6 Dimensions for M632z Flow, M633z Flow

	Printer fully closed	Printer fully opened
Height	1,234 mm (48.5 in)	1,500 mm (59.1 in)
Depth	658 mm (25.9 in)	890 mm (35 in)
Width	661 mm (26 in)	1,030 mm (40.5 in)
Weight (with toner cartridge)	64.3 kg (141.8 lb)	

Table 1-7 Dimensions for the 1x550-sheet paper feeder

	Accessory fully closed	Accessory fully opened
Height	148 mm (5.8 in)	148 mm (5.8 in)
Depth	558 mm (22 in)	869 mm (34.2 in)
Width	512 mm (20.15 in)	617 mm (24.3 in)
Weight	6.8 kg (15 lb)	

Table 1-8 Dimensions for the printer with a 1x550-sheet paper feeder

	Printer fully closed	Printer fully opened
Height	766 mm (30.15 in)	1,010 mm (39.8 in)
Depth	558 mm (22 in)	890 mm (35 in)
Width	512 mm (20.15 in)	1,030 mm (40.5 in)
Weight (with toner cartridge)	40 kg (88.2 lb)	

Table 1-9 Dimensions for the 1x550-sheet feeder with printer stand

	Accessory fully closed	Accessory fully opened
Height	478 mm (18.8 in)	478 mm (18.8 in)
Depth	658 mm (25.9 in)	1,050 mm (41.3 in)
Width	660 mm (26 in)	980 mm (38.6 in)
Weight	19.28 kg (42.5 lb)	

Table 1-10 Dimensions for the printer with a 1x550-sheet feeder with printer stand

	Printer fully closed	Printer fully opened
Height	1,094 mm (43.2 in)	1,365 mm (53.7 in)
Depth	600 mm (26 in)	890 mm (35 in)

Table 1-10 Dimensions for the printer with a 1x550-sheet feeder with printer stand (continued)

	Printer fully closed	Printer fully opened
Width	665 mm (26.15 in)	1,030 mm (40.5 in)
Weight (with toner cartridge)	52.5 kg (115.8 lb)	

Table 1-11 Dimensions for the 1x550-sheet feeder and 2,100-sheet HCI with stand

	Accessory fully closed	Accessory fully opened
Height	478 mm (18.8 in)	478 mm (18.8 in)
Depth	658 mm (25.9 in)	975 mm (38.4 in)
Width	660 mm (26 in)	980 mm (38.6 in)
Weight	24.5 kg (54 lb)	

Table 1-12 Dimensions for the printer with a 1x550-sheet feeder and 2,100-sheet HCI with stand

	Printer fully closed	Printer fully opened
Height	1,090 mm (42.9 in)	1,360 mm (53.5 in)
Depth	658 mm (25.9 in)	890 mm (35 in)
Width	660 mm (26 in)	1,030 mm (40.5 in)
Weight (with toner cartridge)	57.7 kg (127.2 lb)	

Table 1-13 Dimensions for the envelope feeder cassette

	Accessory fully closed	Accessory fully opened
Height	148 mm (5.8 in)	148 mm (5.8 in)
Depth	558 mm (22 in)	869 mm (34.2 in)
Width	512 mm (20.15 in)	617 mm (24.3 in)
Weight	6.9 kg (15.3 lb)	

Table 1-14 Dimensions for the printer with an envelope feeder

	Printer fully closed	Printer fully opened
Height	766 mm (30.15 in)	1,010 mm (39.8 in)
Depth	558 mm (22 in)	890 mm (35 in)
Width	512 mm (20.15 in)	1,030 mm (40.5 in)
Weight (with toner cartridge)	39.6 kg (87.3 lb)	

Table 1-15 Dimensions for the printer with an HP Stapling Mailbox

	Printer fully closed	Printer fully opened
Height	779 mm (30.7 in)	890 mm (35 in)
Depth	558 mm (22 in)	890 mm (35 in)
Width	512 mm (20.15 in)	1,030 mm (40.5 in)
Weight (with toner cartridge)	39.8 kg (87.7 lb)	

¹ These values are subject to change. For current information, go to www.hp.com/support/ljM631MFP, www.hp.com/support/ljM632MFP, or www.hp.com/support/ljM633MFP.

Power consumption, electrical specifications, and acoustic emissions

See www.hp.com/support/ljM631MFP, www.hp.com/support/ljM632MFP, or www.hp.com/support/ljM633MFP for current information.

 **CAUTION:** Power requirements are based on the country/region where the printer is sold. Do not convert operating voltages. This will damage the printer and void the printer warranty.

Operating environment range

Table 1-16 Operating environment range

Environment	Recommended	Allowed
Temperature	17° to 25°C (62.6° to 77°F)	15° to 32.5°C (59° to 90.5°F)
Relative humidity	30% to 70% relative humidity (RH)	10% to 80% RH
Altitude	Not applicable	0 to 3048 m (0 to 10,000 ft)

Printer hardware setup and software installation

For basic setup instructions, see the Hardware Installation Guide that came with the printer. For additional instructions, go to HP support on the Web.

Go to www.hp.com/support/ljM631MFP, www.hp.com/support/ljM632MFP, or www.hp.com/support/ljM633MFP for HP's all-inclusive help for the printer. Find the following support:

- Install and configure
- Learn and use
- Solve problems
- Download software and firmware updates
- Join support forums
- Find warranty and regulatory information

2 Paper trays

- [Introduction](#)
- [Load paper to Tray 1 \(multipurpose tray\)](#)
- [Load Tray 2 and the 550-sheet trays](#)
- [Load the 2,100-sheet high-capacity input tray](#)
- [Load and print envelopes](#)
- [Load and print labels](#)
- [Configure the stapling mailbox accessory](#)

For more information:

The following information is correct at the time of publication. For current information, see www.hp.com/support/ljM631MFP, www.hp.com/support/ljM632MFP, or www.hp.com/support/ljM633MFP.

HP's all-inclusive help for the printer includes the following information:

- Install and configure
- Learn and use
- Solve problems
- Download software and firmware updates
- Join support forums
- Find warranty and regulatory information

Introduction

 **CAUTION:** Do not extend more than one paper tray at a time.

Do not use paper tray as a step.

Keep hands out of paper trays when closing.

All trays must be closed when moving the printer.

Load paper to Tray 1 (multipurpose tray)

The following information describes how to load paper in Tray 1.

⚠ CAUTION: To avoid jams, never add or remove paper from Tray 1 during printing.

1. Open Tray 1.

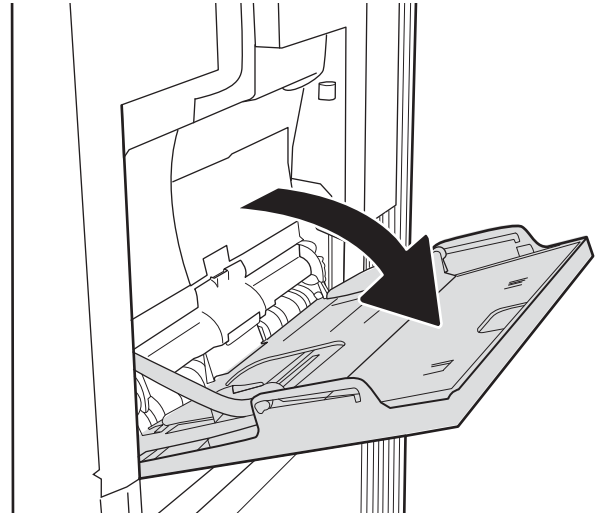

2. Pull out the tray extension to support the paper.

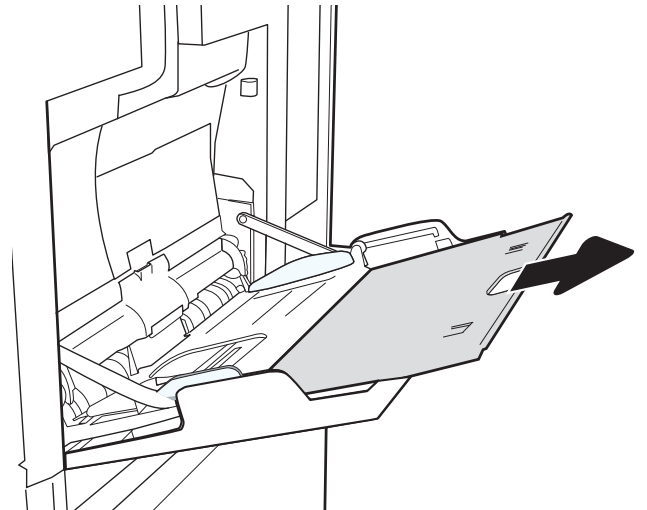

- Use the blue adjustment latch to spread the paper guides to the correct size, and then load paper in the tray. For information about how to orient the paper, see [Table 2-1 Tray 1 paper orientation on page 22](#).

Make sure that the paper fits under the fill line on the paper guides.

NOTE: The maximum stack height is 10 mm (0.4 in), or approximately 100 sheets of 75 g/m² (20 lb) paper.

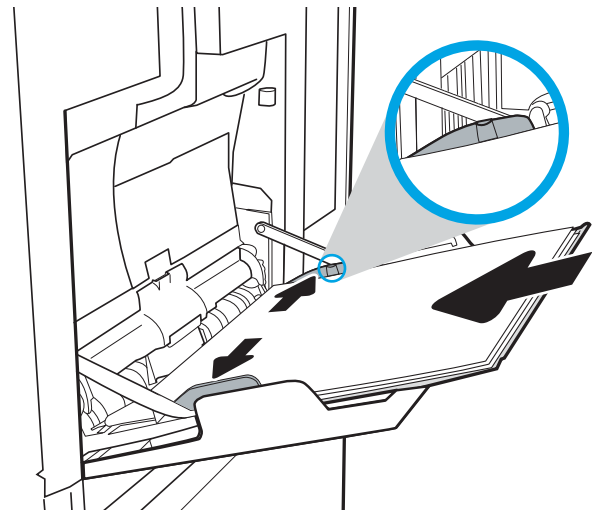

- Using the blue adjustment latch, adjust the side guides so that they touch the paper stack, but do not bend it.

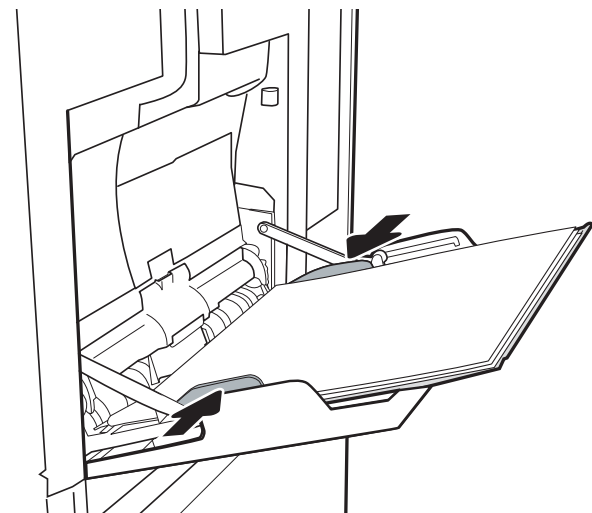

Tray 1 paper orientation

Table 2-1 Tray 1 paper orientation

Paper type	Image orientation	Duplex mode	Paper size	How to load paper
Letterhead or preprinted	Portrait	1-sided printing	Letter, Legal, Executive, Statement, Oficio (8.5 x 13), 3 x 5, 4 x 6, 5 x 7, 5 x 8, A4, A5, A6, RA4, B5 (JIS), B6 (JIS), L (90 x 130 mm), 10 x 15 cm, Oficio (216 x 340), 16K 195 x 270 mm, 16K 184 x 260 mm, 16K 197 x 273 mm, Japanese Postcard (Postcard (JIS)), Double Japan Postcard Rotated (Double Postcard (JIS))	Face-down Bottom edge leading into the printer

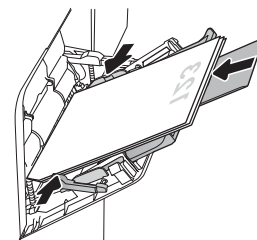

Table 2-1 Tray 1 paper orientation (continued)

Paper type	Image orientation	Duplex mode	Paper size	How to load paper
		Automatic 2-sided printing or with Alternative Letterhead Mode enabled	Letter, Legal, Executive, Oficio (8.5 x 13), A4, A5, RA4, B5 (JIS), Oficio (216 x 340), 16K 195 x 270 mm, 16K 184 x 260 mm, 16K 197 x 273 mm	Face-up Top edge leading into the printer 
	Landscape	1-sided printing	Letter, Legal, Executive, Statement, Oficio (8.5 x 13), 3 x 5, 4 x 6, 5 x 7, 5 x 8, A4, A5, A6, RA4, B5 (JIS), B6 (JIS), L (90 x 130 mm), 10 x 15 cm, Oficio (216 x 340), 16K 195 x 270 mm, 16K 184 x 260 mm, 16K 197 x 273 mm, Japanese Postcard (Postcard (JIS)), Double Japan Postcard Rotated (Double Postcard (JIS))	Face-down Top edge toward the front of the printer 
		Automatic 2-sided printing or with Alternative Letterhead Mode enabled	Letter, Legal, Executive, Oficio (8.5 x 13), A4, A5, RA4, B5 (JIS), Oficio (216 x 340), 16K 195 x 270 mm, 16K 184 x 260 mm, 16K 197 x 273 mm	Face-up Top edge toward the front of the printer 

Table 2-1 Tray 1 paper orientation (continued)

Paper type	Image orientation	Duplex mode	Paper size	How to load paper
Prepunched	Portrait and landscape	1-sided printing	Letter, Legal, Executive, Statement, Oficio (8.5 x 13), 3 x 5, 4 x 6, 5 x 7, 5 x 8, A4, A5, A6, RA4, B5 (JIS), B6 (JIS), L (90 x 130 mm), 10 x 15 cm, Oficio (216 x 340), 16K 195 x 270 mm, 16K 184 x 260 mm, 16K 197 x 273 mm, Japanese Postcard (Postcard (JIS)), Double Japan Postcard Rotated (Double Postcard (JIS))	Holes toward the front of the printer 
		Automatic 2-sided printing or with Alternative Letterhead Mode enabled	Letter, Legal, Executive, Oficio (8.5 x 13), A4, A5, RA4, B5 (JIS), Oficio (216 x 340), 16K 195 x 270 mm, 16K 184 x 260 mm, 16K 197 x 273 mm	Holes toward the front of the printer 

Use alternative letterhead mode

Use the [Alternative Letterhead Mode](#) feature to load letterhead or preprinted paper into the tray the same way for all jobs, whether printing to one side of the sheet of paper or to both sides. When using this mode, load paper as for automatic duplex printing.

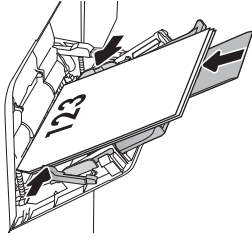
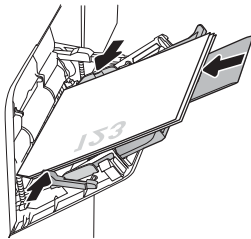
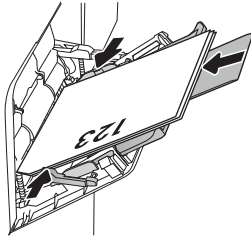
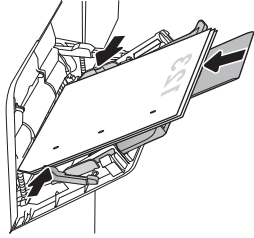
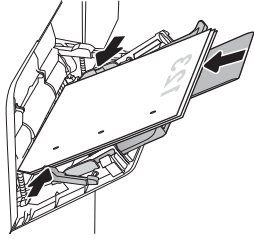
To use the feature, enable it by using the printer control-panel menus.

Enable Alternative Letterhead Mode by using the printer control-panel menus

1. From the Home screen on the printer control panel, open the [Settings](#) menu.
2. Open the following menus:
 - [Print/Copy](#)
 - [Manage Trays](#)
 - [Alternative Letterhead Mode](#)
3. Select [Enabled](#), and then touch the [Save](#) button or press the [OK](#) button.

Load Tray 2 and the 550-sheet trays

Introduction

The following information describes how to load paper into Tray 2 and the optional 550-sheet trays. These trays hold up to 550 sheets of 75 g/m² (20 lb) paper.

 **NOTE:** The procedure to load paper for the 550-sheet trays is the same as for Tray 2. Only Tray 2 is shown here.

1. Open the tray.

NOTE: Do not open this tray while it is in use.

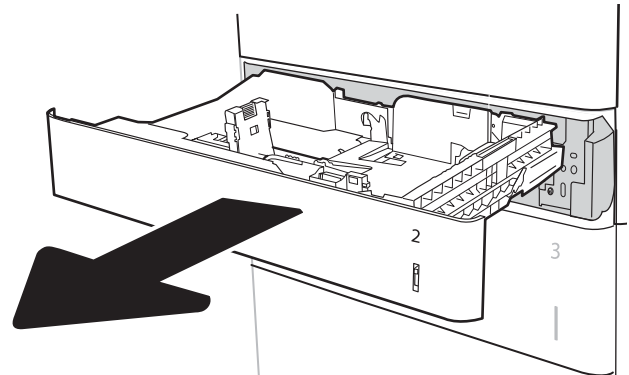

2. Adjust the paper-length and paper-width guides by squeezing the blue adjustment latches and sliding the guides to the size of the paper being used.

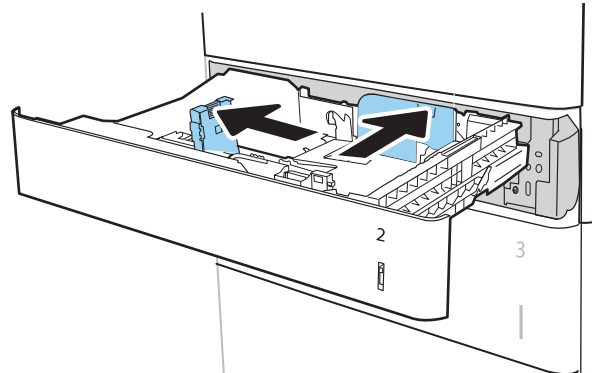

3. Load paper into the tray. Check the paper to verify the guides touch the stack, but do not bend it. For information about how to orient the paper, see [Table 2-2 Tray 2 and the 550-sheet trays paper orientation on page 27](#).

NOTE: To prevent jams, do not overfill the tray. Be sure that the top of the stack is below the tray full indicator.

NOTE: If the tray is not adjusted correctly, an error message might appear during printing or the paper might jam.

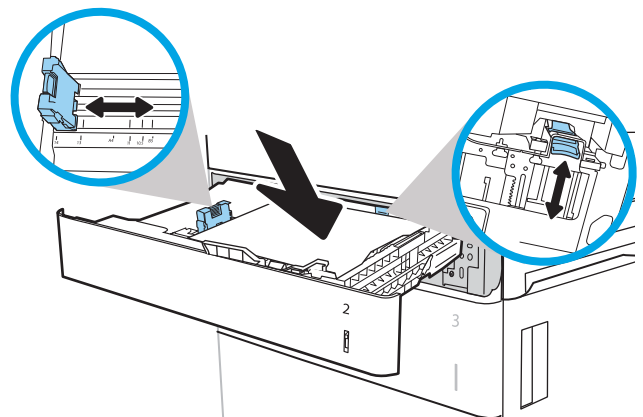

4. Close the tray.

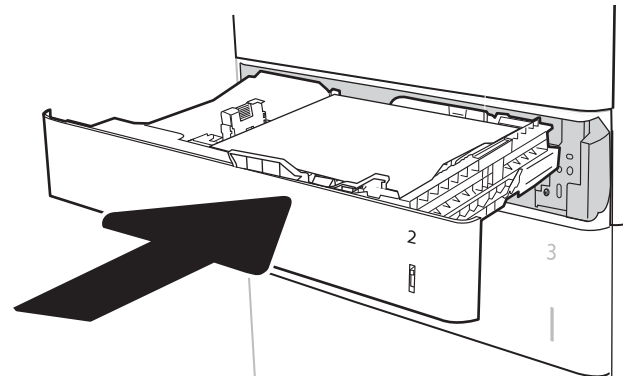

5. The tray configuration message displays on the printer control panel.
6. Touch the **OK** button to accept the detected type and size, or touch the **Modify** button to choose a different paper size or type.

For custom-size paper, specify the X and Y dimensions for the paper when the prompt displays on the printer control panel.

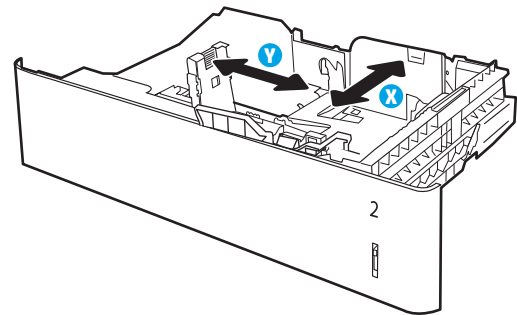

7. Select the correct type and size, and then touch the **OK** button.

Tray 2 and the 550-sheet trays paper orientation

Table 2-2 Tray 2 and the 550-sheet trays paper orientation

Paper type	Image orientation	Duplex mode	Paper size	How to load paper
Letterhead or preprinted	Portrait	1-sided printing	Letter, Legal, Executive, Statement, Oficio (8.5 x 13), 4 x 6, 5 x 7, 5 x 8, A4, A5, A6, RA4, B5 (JIS), B6 (JIS), L (90 x 130 mm), 10 x 15 cm, Oficio (216 x 340), 16K 195 x 270 mm, 16K 184 x 260 mm, 16K 197 x 273 mm, Double Japan Postcard Rotated (Double Postcard (JIS))	Face-up Top edge at the left side of the tray

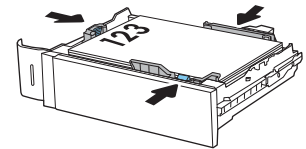
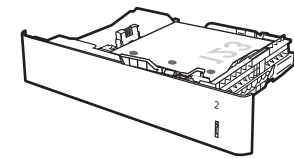
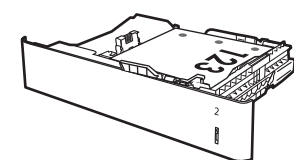
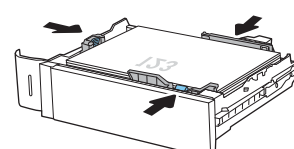
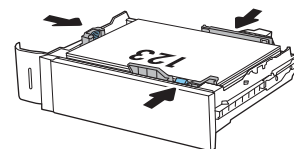

Table 2-2 Tray 2 and the 550-sheet trays paper orientation (continued)

Paper type	Image orientation	Duplex mode	Paper size	How to load paper
	Landscape	1-sided printing	Letter, Legal, Executive, Statement, Oficio (8.5 x 13), 4 x 6, 5 x 7, 5 x 8, A4, A5, A6, RA4, B5 (JIS), B6 (JIS), L (90 x 130 mm), 10 x 15 cm, Oficio (216 x 340), 16K 195 x 270 mm, 16K 184 x 260 mm, 16K 197 x 273 mm, Double Japan Postcard Rotated (Double Postcard (JIS))	Face-up Top edge toward the back of the tray
		Automatic 2-sided printing or with Alternative Letterhead Mode enabled	Letter, Legal, Executive, Oficio (8.5 x 13), A4, A5, RA4, Oficio (216 x 340), 16K 195 x 270 mm, 16K 184 x 260 mm, 16K 197 x 273 mm	Face-down Top edge toward the back of the tray
Prepunched	Portrait or landscape	1-sided printing	Letter, Legal, Executive, Statement, Oficio (8.5 x 13), 4 x 6, 5 x 7, 5 x 8, A4, A5, A6, RA4, B5 (JIS), B6 (JIS), L (90 x 130 mm), 10 x 15 cm, Oficio (216 x 340), 16K 195 x 270 mm, 16K 184 x 260 mm, 16K 197 x 273 mm, Double Japan Postcard Rotated (Double Postcard (JIS))	Face-up Holes toward the back of the tray
		Automatic 2-sided printing or with Alternative Letterhead Mode enabled	Letter, Legal, Executive, Oficio (8.5 x 13), A4, A5, RA4, Oficio (216 x 340), 16K 195 x 270 mm, 16K 184 x 260 mm, 16K 197 x 273 mm	Face-down Holes toward the front of the tray



Use alternative letterhead mode

Use the [Alternative Letterhead Mode](#) feature to load letterhead or preprinted paper into the tray the same way for all jobs, whether printing to one side of the sheet of paper or to both sides. When using this mode, load paper as for automatic duplex printing.

To use the feature, enable it by using the printer control-panel menus.

Enable Alternative Letterhead Mode by using the printer control-panel menus

1. From the Home screen on the printer control panel, open the [Settings](#) menu.
2. Open the following menus:
 - [Copy/Print or Print](#)
 - [Manage Trays](#)
 - [Alternative Letterhead Mode](#)
3. Select [Enabled](#), and then touch the [Save](#) button or press the [OK](#) button.

Load the 2,100-sheet high-capacity input tray

The following information describes how to load paper in the high-capacity input tray. This tray is part of the 1x550-sheet and 2,100-sheet high-capacity input feeder, which is included with the M632z and M633z models. This tray holds up to 2,100 sheets of 75 g/m² (20 lb) paper.

1. Open the tray.

NOTE: Do not open this tray while it is in use.

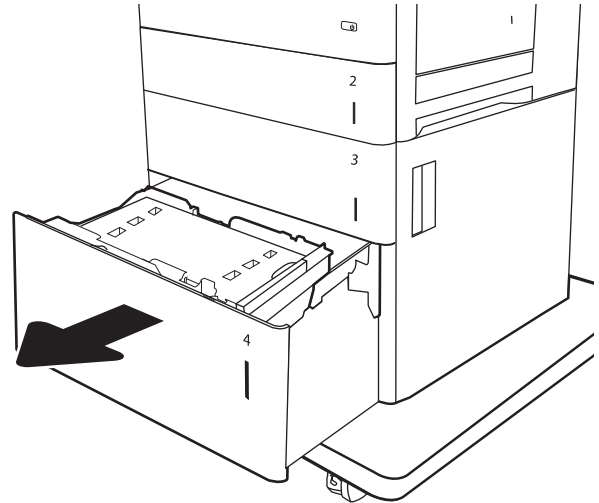

2. Adjust the paper-size lever to the correct position for the paper.

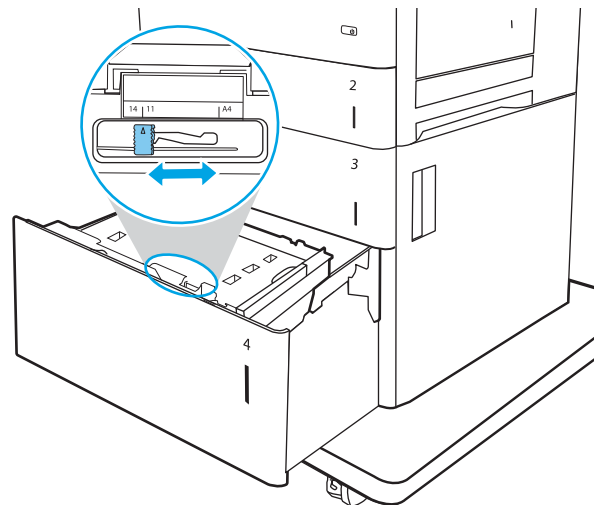

3. Load paper into the tray.

NOTE: To prevent jams, do not overfill the tray. Be sure that the top of the stack is below the tray full indicator.

NOTE: If the tray is not adjusted correctly, an error message might appear during printing or the paper might jam.

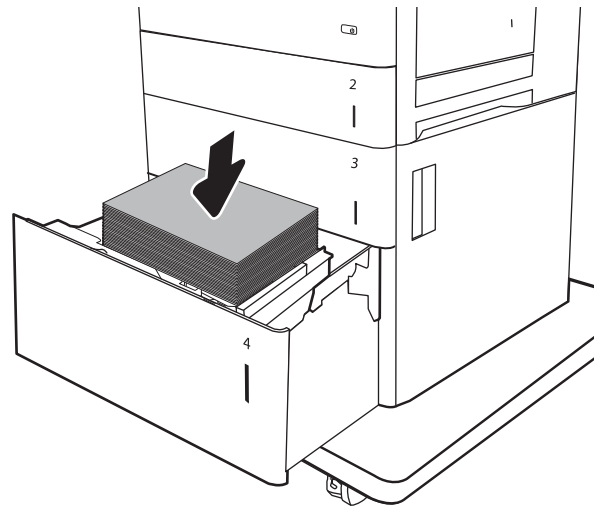

4. Close the tray.

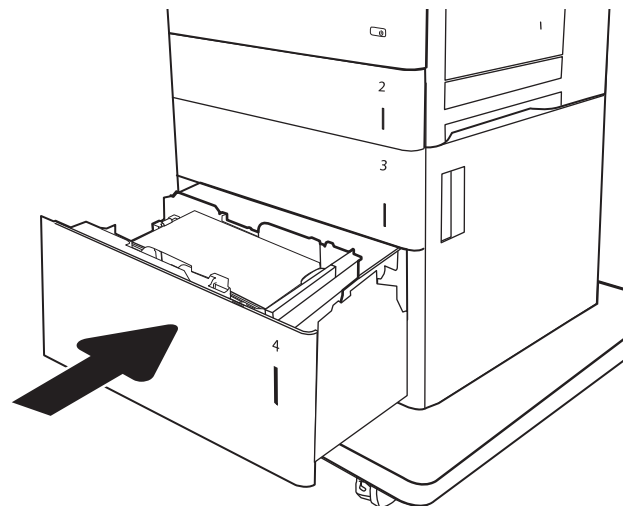

5. The tray configuration message displays on the printer control panel.
6. Touch the **OK** button to accept the detected type and size, or touch the **Modify** button to choose a different paper size or type.
7. Select the correct type and size, and then touch the **OK** button.

Load and print envelopes

Introduction

The following information describes how to load and print envelopes. Use Tray 1 or the envelope feeder accessory to print on envelopes. Tray 1 holds up to 10 envelopes; the envelope feeder accessory holds 75 envelopes, depending on envelope design and environmental conditions.

To print envelopes using the manual feed option, follow these steps to select the correct settings in the print driver, and then load the envelopes into the tray after sending the print job to the printer.

Print envelopes

Print envelopes from Tray 1

1. From the software program, select the **Print** option.
2. Select the printer from the list of printers, and then click or tap the **Properties** or **Preferences** button to open the print driver.

 **NOTE:** The name of the button varies for different software programs.

 **NOTE:** To access these features from a Windows 8 or 8.1 Start screen, select **Devices**, select **Print**, and then select the printer.

3. Click or tap the **Paper/Quality** tab.
4. In the **Paper size** drop-down list, select the correct size for the envelopes.
5. In the **Paper type** drop-down list, select **Envelope**.
6. In the **Paper source** drop-down list, select **Manual feed**.
7. Click the **OK** button to close the **Document Properties** dialog box.
8. In the **Print** dialog box, click the **Print** button to print the job.

Print envelopes from the envelope feeder accessory

1. From the software program, select the **Print** option.
2. Select the printer from the list of printers, and then click or tap the **Properties** or **Preferences** button to open the print driver.

 **NOTE:** The name of the button varies for different software programs.

To access these features from a Windows 8 or 8.1 Start screen, select **Devices**, select **Print**, and then select the printer.

3. Click or tap the **Paper/Quality** tab.
4. Complete one of the following steps:

- In the **Paper size** drop-down list, select the correct size for the envelopes.
 - In the **Paper type** drop-down list, select **Envelope**.
 - In the **Paper source** drop-down list, select **Tray 3** or **Tray 4**—whichever tray corresponds to the envelope feeder.
5. Click the **OK** button to close the **Document Properties** dialog box.
 6. In the **Print** dialog box, click the **OK** button to print the job.

Envelope orientation

Tray	Envelope size	How to load
Tray 1	Envelope #9, Envelope #10, Envelope Monarch, Envelope B5, Envelope C5, Envelope C6, Envelope DL	Face-down Top edge toward the front of the printer
Envelope feeder accessory	Envelope #9, Envelope #10, Envelope Monarch, Envelope B5, Envelope C5, Envelope C6, Envelope DL	Face-up Top edge toward the front of the printer

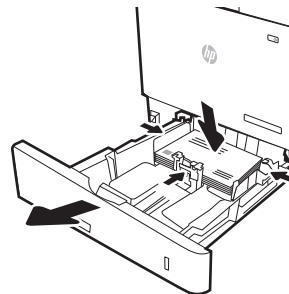
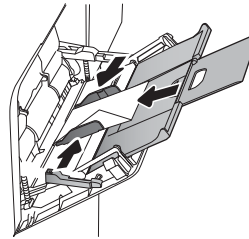

Load and print labels

Introduction

The following information describes how to load and print labels.

To print on sheets of labels, use Tray 2 or one of the optional 550-sheet trays.

 **NOTE:** Tray 1 does not support labels.

To print labels using the manual feed option, follow these steps to select the correct settings in the print driver, and then load the labels into the tray after sending the print job to the printer. When using manual feed, the printer waits to print the job until it detects that the tray has been opened and closed.

Manually feed labels

1. From the software program, select the **Print** option.
2. Select the printer from the list of printers, and then click or tap the **Properties** or **Preferences** button to open the print driver.

 **NOTE:** The name of the button varies for different software programs.

 **NOTE:** To access these features from a Windows 8 or 8.1 Start screen, select **Devices**, select **Print**, and then select the printer.

3. Click the **Paper/Quality** tab.
4. In the **Paper size** drop-down list, select the correct size for the sheets of labels.
5. In the **Paper type** drop-down list, select **Labels**.
6. In the **Paper source** drop-down list, select **Manual feed**.

 **NOTE:** When using manual feed, the printer prints from the lowest-numbered tray that is configured for the correct size of paper, so it is not necessary to specify a particular tray. For example, if Tray 2 is configured for labels, the printer will print from Tray 2. If Tray 3 is installed and configured for labels, but Tray 2 is not configured for labels, the printer will print from Tray 3.

7. Click the **OK** button to close the **Document Properties** dialog box.
8. In the **Print** dialog box, click the **Print** button to print the job.

Label orientation

Tray	How to load labels
Trays 2-5	Face-up Top edge at the right of the tray

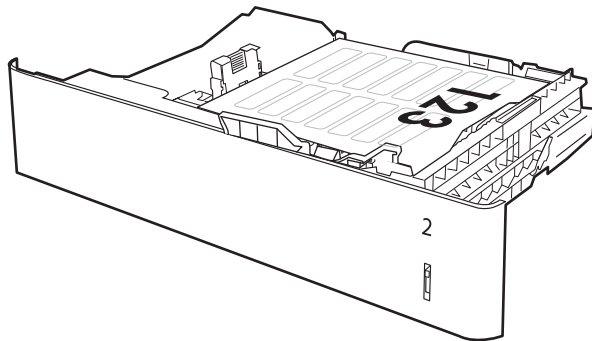

Configure the stapling mailbox accessory

The following information describes how to load staples and configure the options for the stapling mailbox accessory.

The stapling mailbox accessory can staple documents in the upper left or upper right corners, and it can stack up to 1,000 sheets of paper in the three output bins. The output bins have three mode-configuration options: stacker mode, mailbox mode, or function separator mode.

- [Configure the default staple location](#)
- [Configure the operation mode](#)

Configure the default staple location

1. From the Home screen on the printer control panel, swipe until the **Settings** menu displays. Touch the **Settings** icon to open the menu.
2. Open the following menus:
 - **Copy/Print**
 - **Default Print Options**
 - **Staple**
3. Select a staple location from the list of options, and then touch the **Save** button. The following options are available:
 - **None**: No staples
 - **Top left or right**: If the document has portrait orientation, the staple is in the top left corner of the short edge of the paper. If the document has landscape orientation, the staple is in the top right corner of the long edge of the paper.
 - **Top left**: The staple is in the top left corner of the short edge of the paper.
 - **Top right**: The staple is in the top right corner of the long edge of the paper.

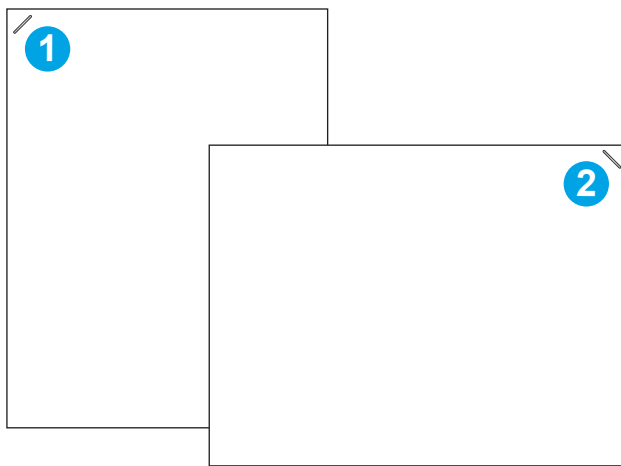

1 Top left corner of the short edge of the paper

2 Top right corner of the long edge of the paper

Configure the operation mode

Use this procedure to configure how the printer sorts jobs into the output bins.

1. From the Home screen on the printer control panel, swipe until the **Settings** menu displays. Touch the **Settings** icon to open the menu.
2. Open the following menus:
 - **Manage Stapler/Stacker**
 - **Operation Mode**
3. Select a mode from the list of options, and then touch the **Save** button. The following options are available:
 - **Mailbox**: The printer places jobs in different bins according to the person who sent them.
 - **Stacker**: The printer stacks jobs in the bins from bottom to top.
 - **Function Separator**: The printer places jobs in different bins according to printer function such as print jobs, copy jobs, or fax jobs.

To configure the HP print driver for the selected operation mode, complete the following steps:

 **NOTE:** Changing the operation mode causes the printer to restart.

Windows XP and Vista (Server 2003/2008) HP PCL.6 drivers do not support output devices.

Windows® 7

1. Make sure the printer is turned on and connected to the computer or a network.
2. Open the Windows® Start menu, and then click **Devices and Printers**.
3. Right-click the name of the printer, and then select **Printer Properties**.
4. Click the **Device Settings** tab.
5. Select **Update Now**. Or, in the drop-down menu next to **Automatic Configuration**, select **Update Now**.

Windows® 8.0, 8.1, and 10

1. Right-click on the bottom-left corner of the screen.
2. Select **Control Panel**. Under **Hardware and Sound**, select **View devices and printers**.
3. Right-click the name of the printer, and then select **Printer Properties**.
4. Click the **Device Settings** tab.
5. Select **Update Now**. Or, in the drop-down menu next to **Automatic Configuration**, select **Update Now**.

 **NOTE:** Newer V4 drivers do not support **Update Now**. For these drivers, manually configure the operation mode under **Accessory Output Bin**.

OS X

1. From the Apple menu, click **System Preferences**.
2. Select **Print & Scan** (or **Printers & Scanners**).

3. Select the printer, and then select **Options & Supplies**. Select **Driver**.
4. Manually configure the **Accessory Output Mode**.

3 Supplies, accessories, and parts

- [Order supplies, accessories, and parts](#)
- [Configure the HP toner-cartridge-protection supply settings](#)
- [Replace the toner cartridge](#)
- [Replace the staple cartridge](#)

For more information:

The following information is correct at the time of publication. For current information, see www.hp.com/support/ljM631MFP, www.hp.com/support/ljM632MFP, or www.hp.com/support/ljM633MFP.

HP's all-inclusive help for the printer includes the following information:

- Install and configure
- Learn and use
- Solve problems
- Download software and firmware updates
- Join support forums
- Find warranty and regulatory information

Order supplies, accessories, and parts

Ordering

Order supplies and paper	www.hp.com/go/suresupply
Order genuine HP parts or accessories	www.hp.com/buy/parts
Order through service or support providers	Contact an HP-authorized service or support provider.
Order using the HP Embedded Web Server (EWS)	To access, in a supported Web browser on your computer, enter the printer IP address or host name in the address/URL field. The EWS contains a link to the HP SureSupply website, which provides options for purchasing Original HP supplies.

Supplies and accessories

Item	Description	Cartridge number	Part number
Supplies			
HP 37Y Extra High Yield Black Original LaserJet Toner Cartridge	Extra high-capacity replacement toner cartridge	37Y	CF237Y
HP 37X High Yield Black Original LaserJet Toner Cartridge	High-capacity replacement toner cartridge	37X	CF237X
HP 37A Black Original LaserJet Toner Cartridge	Standard-capacity replacement toner cartridge	37A	CF237A
HP Staple Cartridge Refill	Replacement staple cartridge	Not applicable	C5967A
Accessories			
1 GB Memory DIMM Kit	Memory upgrade kit	Not applicable	E5K48A
HP LaserJet 550-sheet Paper Tray	Optional input tray	Not applicable	J8J89A
HP LaserJet 1x550-sheet paper feeder with cabinet	Optional input tray with cabinet stand	Not applicable	J8J91A
HP LaserJet 1x550-sheet feeder plus 2,100-sheet HCL feeder with stand	Optional input tray with high-capacity input feeder and stand	Not applicable	J8J92A
HP LaserJet 3x550-sheet paper feeder with cabinet	Optional input trays (three) with cabinet	Not applicable	J8J93A
HP LaserJet Envelope Feeder	Optional envelope feeder input tray	Not applicable	J8J90A
HP Internal USB Ports	Optional USB ports for connecting third-party devices	Not applicable	B5L28A
HP Secure High Performance Hard Disk Drive	Replacement hard drive	Not applicable	B5L29A
HP Foreign Interface Harness (FIH)	Optional interface portal	Not applicable	B5L31A
HP LaserJet MFP Analog Fax Accessory 500	Analog fax accessory	Not applicable	CC487A

Item	Description	Cartridge number	Part number
HP Jetdirect 2900nw Print Server	USB wireless print server accessory	Not applicable	J8031A
HP Jetdirect 3000w NFC/Wireless Accessory	Wireless accessory for “touch” printing from mobile devices	Not applicable	J8030A
HP Trusted Platform Module Accessory	Automatic encryption accessory	Not applicable	F5562A

Maintenance/long-life consumables

Maintenance/LLC Kit	Part number	Estimated life ¹
HP LaserJet 110v Maintenance Kit	J8J87A	225,000 pages
HP LaserJet 220v Maintenance Kit	J8J88A	225,000 pages
HP 300 ADF Roller Replacement Kit	J8J95A	150,000 pages

¹ HP Maintenance/Long Life Consumables (LLC) life specifications are estimations based on the LLC life test conditions listed below. Actual individual life/yield during normal use varies depending on usage, environment, paper and other factors. Estimated life is not an implied guarantee or warrantable.

The LLC life test conditions

- Print coverage: 5% evenly distributed across the page
- Environment: 17° to 25°C (62.6° to 77°F); 30%–70% relative humidity (RH)
- Media size: Letter/A4
- Media weight: 75 g/m² (20 lb) plain media
- Job size: 4 pages
- Short edge feed (A3) (i.e., Legal size media)

Factors that can reduce life from the conditions above:

- Media narrower than Letter/A4 widths (thermal slow downs equal more rotations)
- Paper heavier than 75 g/m² (20 lb) (heavier media creates higher stress on printer components)
- Print jobs smaller than 4 image (smaller jobs mean more thermal cycling and more rotations)

Customer self-repair parts

The following parts are available for the printer.

- Parts listed as **Mandatory** self-replacement are to be installed by customers, unless you are willing to pay HP service personnel to perform the repair. For these parts, on-site or return-to-depot support is not provided under the HP product warranty.
- Parts listed as **Optional** self-replacement can be installed by HP service personnel at your request for no additional charge during the product warranty period.

Item	Description	Self-replacement options	Part number
HP LaserJet Keyboard Overlay Kit for Simplified Chinese and Traditional Chinese	Keyboard overlay for China	Mandatory	A7W12A
HP LaserJet Keyboard Overlay Kit Sweden	Keyboard overlay for Sweden	Mandatory	A7W14A

Configure the HP toner-cartridge-protection supply settings

- [Introduction](#)
- [Enable or disable the Cartridge Policy feature](#)
- [Enable or disable the Cartridge Protection feature](#)

Introduction

Use HP Cartridge Policy and Cartridge Protection to control which cartridges are installed in the printer and protect the cartridges that are installed from theft. These features are available with HP FutureSmart versions 3 and later.

- **Cartridge Policy:** This feature protects the printer from counterfeit toner cartridges by allowing only genuine HP cartridges to be used with the printer. Using genuine HP cartridges ensures the best possible print quality. When someone installs a cartridge that is not a genuine HP cartridge, the printer control panel displays a message that the cartridge is unauthorized and it provides information explaining how to proceed.
- **Cartridge Protection:** This feature permanently associates toner cartridges with a specific printer, or fleet of printers, so they cannot be used in other printers. Protecting cartridges protects your investment. When this feature is enabled, if someone attempts to transfer a protected cartridge from the original printer into an unauthorized printer, that printer will not print with the protected cartridge. The printer control panel displays a message that the cartridge is protected, and it provides information explaining how to proceed.

 **CAUTION:** After enabling cartridge protection for the printer, all subsequent toner cartridges installed in the printer are automatically and *permanently* protected. To avoid protecting a new cartridge, disable the feature *before* installing the new cartridge.

Turning the feature off does not turn off protection for cartridges that are currently installed.

Both features are off by default. Follow these procedures to enable or disable them.

Enable or disable the Cartridge Policy feature

 **NOTE:** Enabling or disabling this feature might require entering an administrator password.

Use the printer control panel to enable the Cartridge Policy feature

1. From the Home screen on the printer control panel, open the [Settings](#) menu.
2. Open the following menus:
 - [Manage Supplies](#)
 - [Cartridge Policy](#)
3. Select [Authorized HP](#).



Use the printer control panel to disable the Cartridge Policy feature

 **NOTE:** Enabling or disabling this feature might require entering an administrator password.

1. From the Home screen on the printer control panel, open the [Settings](#) menu.
2. Open the following menus:

- [Manage Supplies](#)
 - [Cartridge Policy](#)
3. Select **Off**.

Use the HP Embedded Web Server (EWS) to enable the Cartridge Policy feature

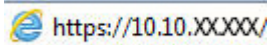

1. Open the HP Embedded Web Server (EWS):
 - a. From the Home screen on the printer control panel, touch the Information  icon, and then touch the Network  icon to display the IP address or host name.
 - b. Open a web browser, and in the address line, type the IP address or host name exactly as it displays on the printer control panel. Press the **Enter** key on the computer keyboard. The EWS opens.



 **NOTE:** If the web browser displays a message indicating that accessing the website might not be safe, select the option to continue to the website. Accessing this website will not harm the computer.

2. Open the **Copy/Print** tab.
3. From the left navigation pane, select **Manage Supplies**.
4. In the Supply Settings area, select **Authorized HP** from the **Cartridge Policy** drop-down list.
5. Click the **Apply** button to save the changes.

Use the HP Embedded Web Server (EWS) to disable the Cartridge Policy feature

1. Open the HP Embedded Web Server (EWS):
 - a. From the Home screen on the printer control panel, touch the Information  icon, and then touch the Network  icon to display the IP address or host name.
 - b. Open a web browser, and in the address line, type the IP address or host name exactly as it displays on the printer control panel. Press the **Enter** key on the computer keyboard. The EWS opens.

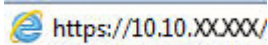

 **NOTE:** If the web browser displays a message indicating that accessing the website might not be safe, select the option to continue to the website. Accessing this website will not harm the computer.

2. Open the **Copy/Print** tab.
3. From the left navigation pane, select **Manage Supplies**.
4. In the Supply Settings area, select **Off** from the **Cartridge Policy** drop-down list.
5. Click the **Apply** button to save the changes.

Troubleshoot Cartridge Policy control panel error messages

Error message	Description	Recommended action
10.0X.30 Unauthorized <Color> Cartridge	The administrator has configured this printer to use only genuine HP supplies that are still under warranty. The cartridge must be replaced to continue printing.	Replace the cartridge with a genuine HP toner cartridge. If you believe you purchased a genuine HP supply, visit www.hp.com/go/anticounterfeit to determine if the toner cartridge is a genuine HP cartridge, and learn what to do if it is not a genuine HP cartridge.

Enable or disable the Cartridge Protection feature

 **NOTE:** Enabling or disabling this feature might require entering an administrator password.

Use the printer control panel to enable the Cartridge Protection feature

1. From the Home screen on the printer control panel, open the [Settings](#) menu.
2. Open the following menus:
 - [Manage Supplies](#)
 - [Cartridge Protection](#)
3. Select [Protect Cartridges](#).
4. When the printer prompts to confirm, select [Continue](#) to enable the feature.



 **CAUTION:** After enabling cartridge protection for the printer, all subsequent toner cartridges installed in the printer are automatically and *permanently* protected. To avoid protecting a new cartridge, disable the feature *before* installing the new cartridge.

Turning the feature off does not turn off protection for cartridges that are currently installed.

Use the printer control panel to disable the Cartridge Protection feature

1. From the Home screen on the printer control panel, open the [Settings](#) menu.
2. Open the following menus:
 - [Manage Supplies](#)
 - [Cartridge Protection](#)
3. Select [Off](#).

Use the HP Embedded Web Server (EWS) to enable the Cartridge Protection feature

1. Open the HP Embedded Web Server (EWS):
 - a. From the Home screen on the printer control panel, touch the Information  icon, and then touch the Network  icon to display the IP address or host name.

- b. Open a web browser, and in the address line, type the IP address or host name exactly as it displays on the printer control panel. Press the **Enter** key on the computer keyboard. The EWS opens.

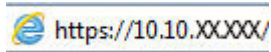

NOTE: If the web browser displays a message indicating that accessing the website might not be safe, select the option to continue to the website. Accessing this website will not harm the computer.

2. Open the **Copy/Print** tab.
3. From the left navigation pane, select **Manage Supplies**.
4. In the Supply Settings area, select **Protect cartridges** from the **Cartridge Protection** drop-down list.
5. Click the **Apply** button to save the changes.

CAUTION: After enabling cartridge protection for the printer, all subsequent toner cartridges installed in the printer are automatically and *permanently* protected. To avoid protecting a new cartridge, disable the feature *before* installing the new cartridge.

Turning the feature off does not turn off protection for cartridges that are currently installed.

Use the HP Embedded Web Server (EWS) to disable the Cartridge Protection feature

1. Open the HP Embedded Web Server (EWS):
 - a. From the Home screen on the printer control panel, touch the Information **i** icon, and then touch the Network  icon to display the IP address or host name.
 - b. Open a web browser, and in the address line, type the IP address or host name exactly as it displays on the printer control panel. Press the **Enter** key on the computer keyboard. The EWS opens.

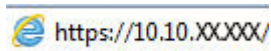

NOTE: If the web browser displays a message indicating that accessing the website might not be safe, select the option to continue to the website. Accessing this website will not harm the computer.

2. Open the **Copy/Print** tab.
3. From the left navigation pane, select **Manage Supplies**.
4. In the Supply Settings area, select **Off** from the **Cartridge Protection** drop-down list.
5. Click the **Apply** button to save the changes.

Troubleshoot Cartridge Protection control panel error messages

Error message	Description	Recommended action
10.0X.57 Protected <Color> Cartridge	<p>The cartridge can only be used in the printer or fleet of printers that initially protected it using HP Cartridge Protection.</p> <p>The Cartridge Protection feature allows an administrator to restrict cartridges to work in only one printer or fleet of printers. The cartridge must be replaced to continue printing.</p>	Replace the cartridge with a new toner cartridge.

Replace the toner cartridge

This printer indicates when the toner cartridge level is low. The actual toner cartridge life remaining can vary. The toner cartridge does not need to be replaced at this time. Consider having a replacement cartridge available to install when print quality is no longer acceptable.

Continue printing with the current cartridge until redistributing the toner no longer yields acceptable print quality. To redistribute the toner, remove the toner cartridge from the printer and gently rock the cartridge back and forth about its horizontal axis. For graphical representation, see cartridge replacement instructions. Reinsert the toner cartridge into the printer and close the cover.

Table 3-1 Toner cartridge information

Item	Description	Cartridge number	Part number
HP 37Y Extra High Yield Black Original LaserJet Toner Cartridge	Extra high-capacity replacement toner cartridge	37Y	CF237Y
HP 37X High Yield Black Original LaserJet Toner Cartridge	High-capacity replacement toner cartridge	37X	CF237X
HP 37A Black Original LaserJet Toner Cartridge	Standard-capacity replacement toner cartridge	37A	CF237A

Do not remove the toner cartridge from its package until you are ready to use it.

CAUTION: To prevent damage to the toner cartridge, do not expose it to light for more than a few minutes. Cover the green imaging drum if the toner cartridge must be removed from the printer for an extended period of time.

The following illustration shows the toner-cartridge components.

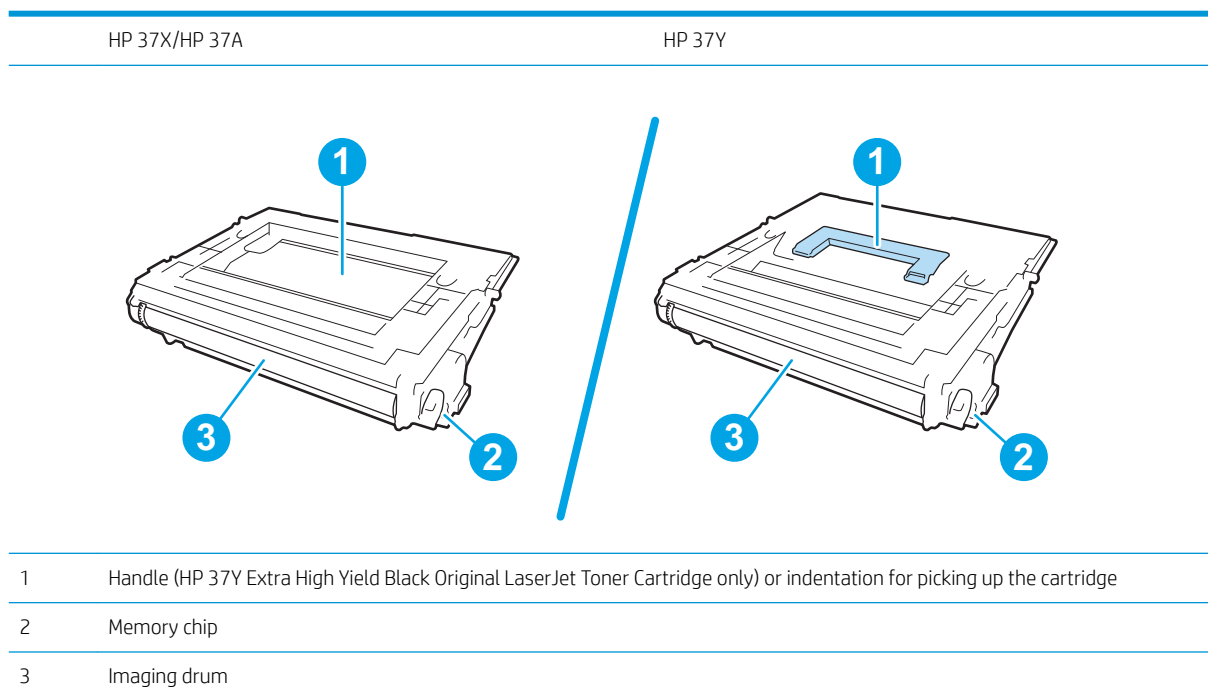

- 1 Handle (HP 37Y Extra High Yield Black Original LaserJet Toner Cartridge only) or indentation for picking up the cartridge
- 2 Memory chip
- 3 Imaging drum

CAUTION: Do not touch the imaging drum. Fingerprints can cause print-quality problems.

⚠ CAUTION: If toner gets on clothing, wipe it off by using a dry cloth and wash the clothes in cold water. Hot water sets toner into fabric.

📄 NOTE: Information about recycling used toner cartridges is on the toner cartridge box.

1. Press the cartridge door release button to open the door.

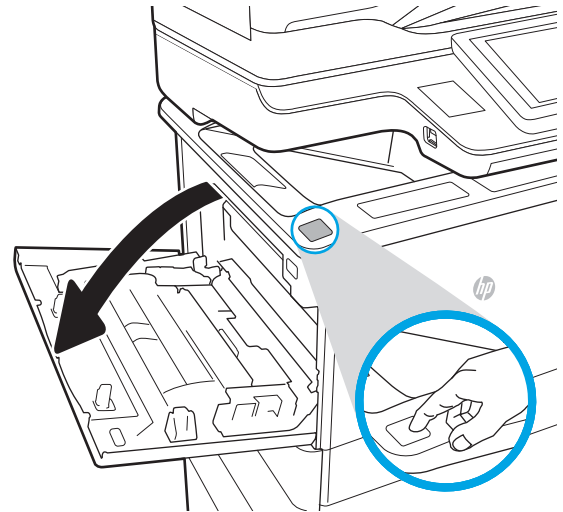

2. Pull out the cartridge drawer.

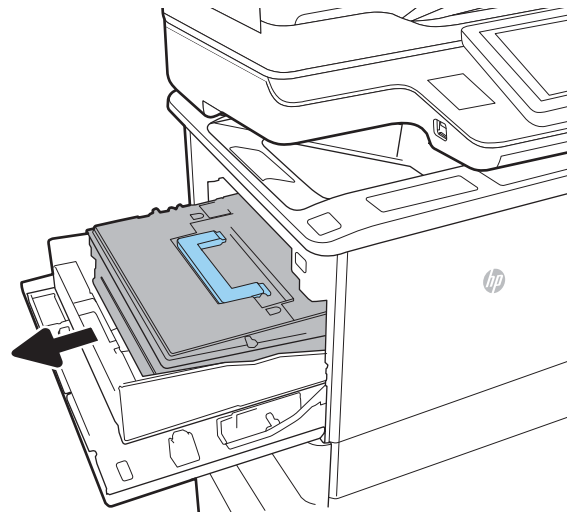

3. Grasp the handle or indentation of the used toner cartridge and pull up to remove it.

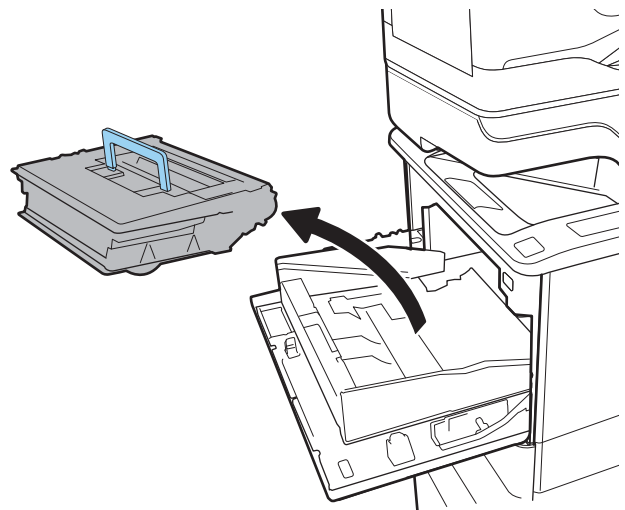

4. Remove the new toner cartridge from its protective bag.

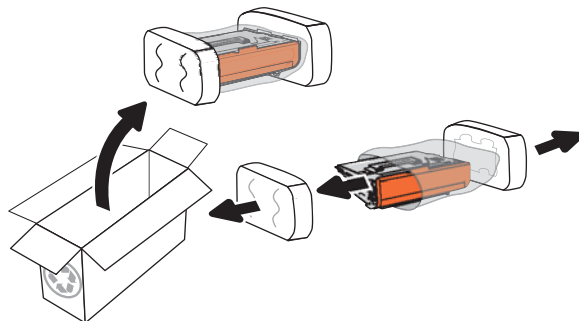

5. Hold both ends of the toner cartridge and rock it 5-6 times.

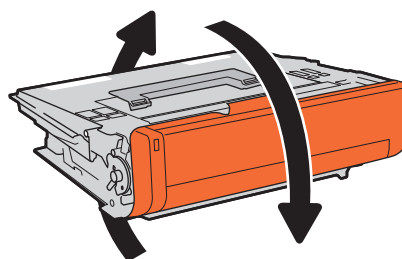

6. Remove the cartridge shipping cover.

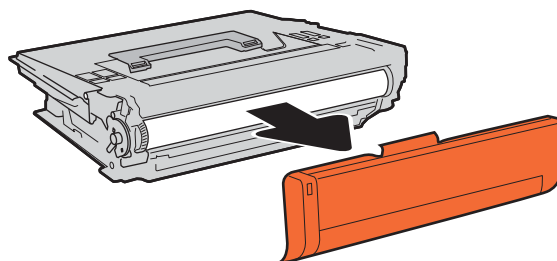

7. Place the toner cartridge in the cartridge drawer.

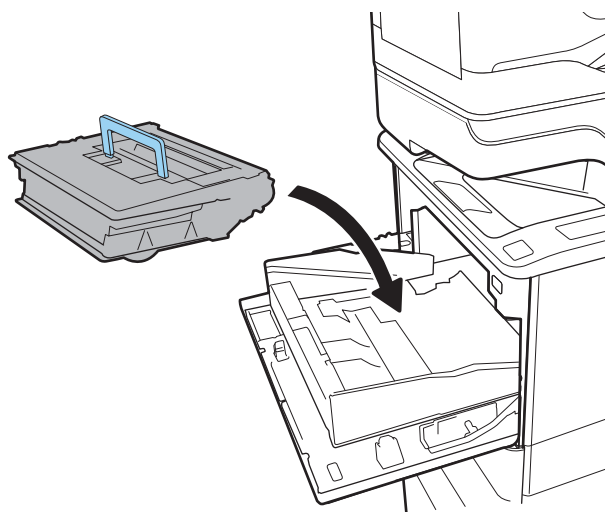

8. Close the toner cartridge drawer.

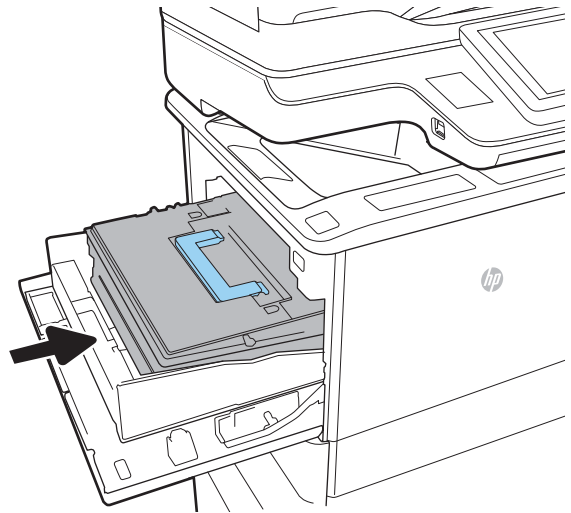

9. Close the cartridge door.

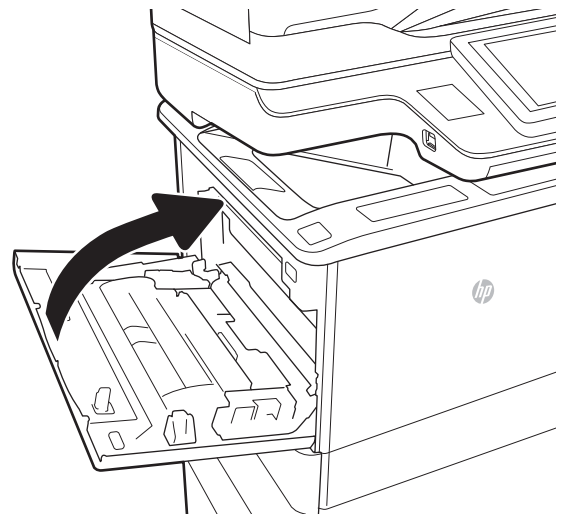

10. Pack the used toner cartridge into the box that the new cartridge came in. Adhere the prepaid shipping label to the box, and return the used cartridge to HP for recycling.

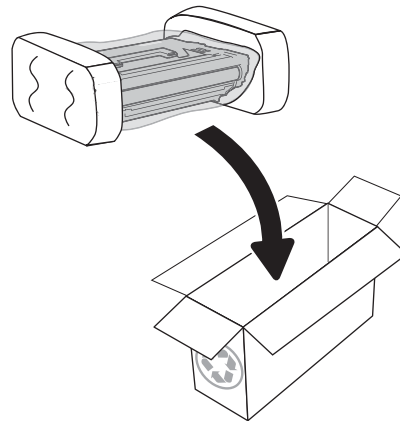

Replace the staple cartridge

1. Open the stapler door.

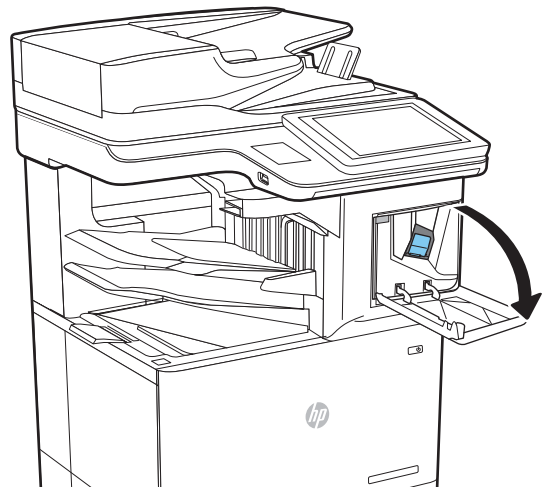

2. Pull the colored handle on the staple cartridge, and then pull the staple cartridge straight out.

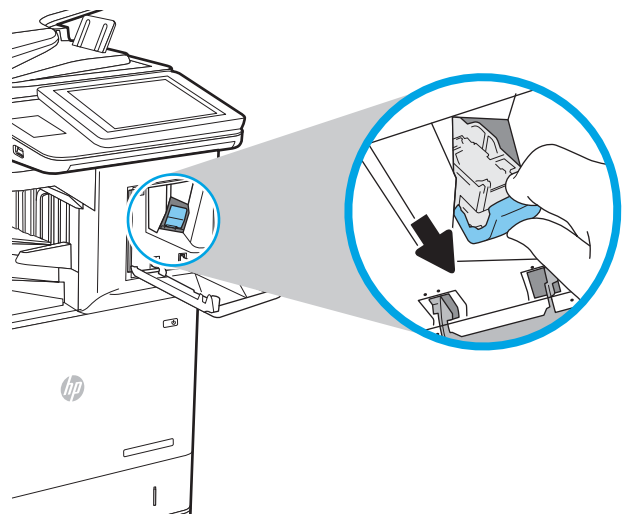

3. Insert the new staple cartridge into the stapler and push on the colored handle until it snaps into place.

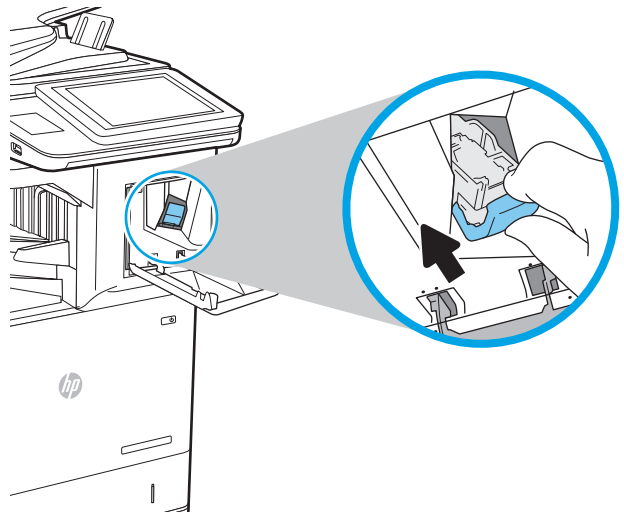

4. Close the stapler door.

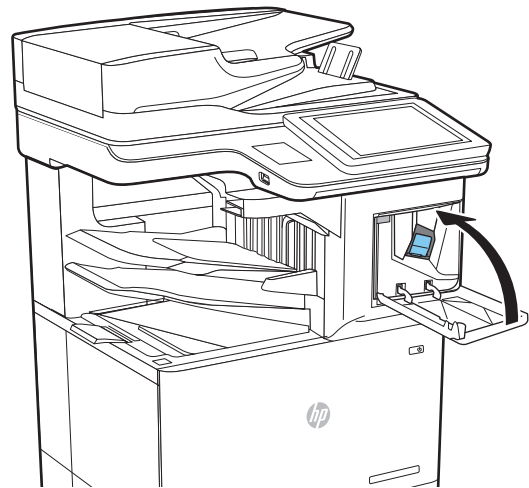

4 Print

- [Print tasks \(Windows\)](#)
- [Print tasks \(OS X\)](#)
- [Store print jobs on the printer to print later or print privately](#)
- [Mobile printing](#)
- [Print from the USB port](#)

For more information:

The following information is correct at the time of publication. For current information, see www.hp.com/support/ljM631MFP, www.hp.com/support/ljM632MFP, or www.hp.com/support/ljM633MFP.

HP's all-inclusive help for the printer includes the following information:

- Install and configure
- Learn and use
- Solve problems
- Download software and firmware updates
- Join support forums
- Find warranty and regulatory information

Print tasks (Windows)

How to print (Windows)

The following procedure describes the basic printing process for Windows.

1. From the software program, select the **Print** option.
2. Select the printer from the list of printers. To change settings, click the **Properties** or **Preferences** button to open the print driver.

 **NOTE:** The name of the button varies for different software programs.

 **NOTE:** To access these features from a Windows 8 or 8.1 Start screen app, select **Devices**, select **Print**, and then select the printer.

 **NOTE:** For more information, click the Help (?) button in the print driver.

 **NOTE:** The print driver might look different than what is shown here, but the steps are the same.

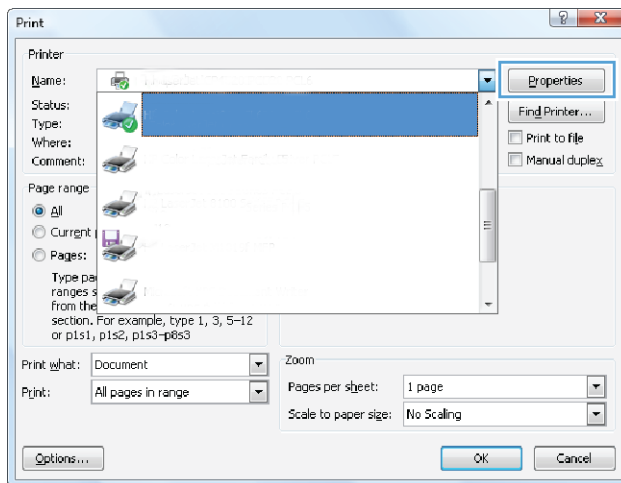

3. Click the tabs in the print driver to configure the available options. For example, set the paper orientation on the **Finishing** tab, and set the paper source, paper type, paper size, and quality settings on the **Paper/Quality** tab.

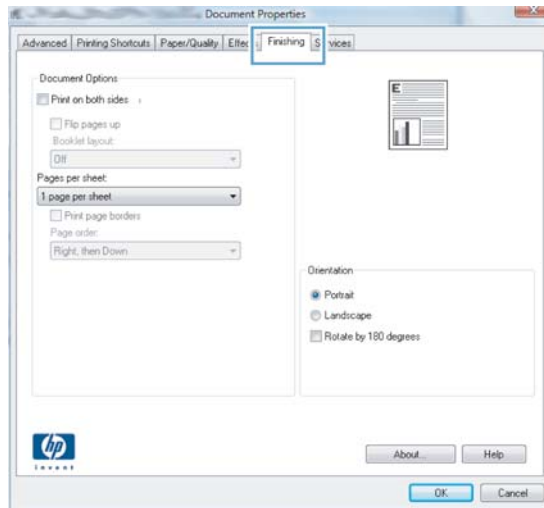

4. Click the **OK** button to return to the **Print** dialog box. Select the number of copies to print from this screen.
5. Click the **Print** button to print the job.

Automatically print on both sides (Windows)

Use this procedure for printers that have an automatic duplexer installed. If the printer does not have an automatic duplexer installed, or to print on paper types that the duplexer does not support, print on both sides manually.

1. From the software program, select the **Print** option.
2. Select the printer from the list of printers, and then click the **Properties** or **Preferences** button to open the print driver.

 **NOTE:** The name of the button varies for different software programs.

 **NOTE:** To access these features from a Windows 8 or 8.1 Start screen app, select **Devices**, select **Print**, and then select the printer.

3. Click the **Finishing** tab.
4. Select **Print on both sides**. Click **OK** to close the **Document Properties** dialog.
5. In the **Print** dialog, click **Print** to print the job.

Manually print on both sides (Windows)

Use this procedure for printers that do not have an automatic duplexer installed or to print on paper that the duplexer does not support.

1. From the software program, select the **Print** option.
2. Select the printer from the list of printers, and then click the **Properties** or **Preferences** button to open the print driver.

 **NOTE:** The name of the button varies for different software programs.

 **NOTE:** To access these features from a Windows 8 or 8.1 Start screen app, select **Devices**, select **Print**, and then select the printer.

3. Click the **Finishing** tab.
4. Select **Print on both sides (manually)**, and then click **OK** to close the Document Properties dialog.
5. In the Print dialog, click **Print** to print the first side of the job.
6. Retrieve the printed stack from the output bin, and place it in Tray 1.
7. If prompted, touch the appropriate control panel button to continue.

Print multiple pages per sheet (Windows)

1. From the software program, select the **Print** option.
2. Select the printer from the list of printers, and then click the **Properties** or **Preferences** button to open the print driver.

 **NOTE:** The name of the button varies for different software programs.

 **NOTE:** To access these features from a Windows 8 or 8.1 Start screen app, select **Devices**, select **Print**, and then select the printer.

3. Click the **Finishing** tab.
4. Select the number of pages per sheet from the **Pages per sheet** drop-down.
5. Select the correct **Print page borders**, **Page order**, and **Orientation** options. Click **OK** to close the **Document Properties** dialog.
6. In the **Print** dialog, click **Print** to print the job.

Select the paper type (Windows)

1. From the software program, select the **Print** option.
2. Select the printer from the list of printers, and then click the **Properties** or **Preferences** button to open the print driver.

 **NOTE:** The name of the button varies for different software programs.

 **NOTE:** To access these features from a Windows 8 or 8.1 Start screen app, select **Devices**, select **Print**, and then select the printer.

3. Click the **Paper/Quality** tab.
4. From the **Paper type** drop-down, select the **More...** option.
5. Expand the list of **Type is:** options.
6. Expand the category of paper types that best describes your paper.
7. Select the option for the type of paper you are using, and then click **OK**.
8. Click **OK** to close the **Document Properties** dialog. In the **Print** dialog, click **Print** to print the job.

If the tray needs to be configured, a tray configuration message displays on the printer control panel.
9. Load the tray with the specified type and size of paper, and then close the tray.
10. Touch the **OK** button to accept the detected type and size, or touch the **Modify** button to choose a different paper size or type.
11. Select the correct type and size, and then touch the **OK** button.

Additional print tasks

Go to www.hp.com/support/ljM631MFP, www.hp.com/support/ljM632MFP, or www.hp.com/support/ljM633MFP.

Instructions are available for performing specific print tasks, such as the following:

- Create and use printing shortcuts or presets
- Select the paper size, or use a custom paper size
- Select the page orientation
- Create a booklet
- Scale a document to fit a specific paper size
- Print the first or last pages of the document on different paper
- Print watermarks on a document

Print tasks (OS X)

How to print (OS X)

The following procedure describes the basic printing process for OS X.

1. Click the **File** menu, and then click the **Print** option.
2. Select the printer.
3. Click **Show Details** or **Copies & Pages**, and then select other menus to adjust the print settings.

 **NOTE:** The name of the item varies for different software programs.

4. Click the **Print** button.

Automatically print on both sides (OS X)

 **NOTE:** This information applies to printers that include an automatic duplexer.

 **NOTE:** This feature is available if you install the HP print driver. It might not be available if you are using AirPrint.

1. Click the **File** menu, and then click the **Print** option.
2. Select the printer.
3. Click **Show Details** or **Copies & Pages**, and then click the **Layout** menu.

 **NOTE:** The name of the item varies for different software programs.

4. Select a binding option from the **Two-Sided** drop-down list.
5. Click the **Print** button.

Manually print on both sides (OS X)

 **NOTE:** This feature is available if you install the HP print driver. It might not be available if you are using AirPrint.

1. Click the **File** menu, and then click the **Print** option.
2. Select the printer.
3. Click **Show Details** or **Copies & Pages**, and then click the **Manual Duplex** menu.

 **NOTE:** The name of the item varies for different software programs.

4. Click the **Manual Duplex** box, and select a binding option.
5. Click the **Print** button.
6. Go to the printer, and remove any blank paper that is in Tray 1.
7. Retrieve the printed stack from the output bin and place it with the printed-side facing down in the input tray.
8. If prompted, touch the appropriate control panel button to continue.

Print multiple pages per sheet (OS X)

1. Click the **File** menu, and then click the **Print** option.
2. Select the printer.
3. Click **Show Details** or **Copies & Pages**, and then click the **Layout** menu.



NOTE: The name of the item varies for different software programs.

4. From the **Pages per Sheet** drop-down list, select the number of pages that you want to print on each sheet.
5. In the **Layout Direction** area, select the order and placement of the pages on the sheet.
6. From the **Borders** menu, select the type of border to print around each page on the sheet.
7. Click the **Print** button.

Select the paper type (OS X)

1. Click the **File** menu, and then click the **Print** option.
2. Select the printer.
3. Click **Show Details** or **Copies & Pages**, and then click the **Media & Quality** menu or the **Paper/Quality** menu.



NOTE: The name of the item varies for different software programs.

4. Select from the **Media & Quality** or **Paper/Quality** options.



NOTE: This list contains the master set of options available. Some options are not available on all printers.

- **Media Type:** Select the option for the type of paper for the print job.
 - **Print Quality:** Select the resolution level for the print job.
 - **Edge-To-Edge Printing:** Select this option to print close to the paper edges.
 - **EconoMode:** Select this option to conserve toner when printing drafts of documents.
5. Click the **Print** button.

Additional print tasks

Go to www.hp.com/support/ljM631MFP, www.hp.com/support/ljM632MFP, or www.hp.com/support/ljM633MFP.

Instructions are available for performing specific print tasks, such as the following:

- Create and use printing shortcuts or presets
- Select the paper size, or use a custom paper size
- Select the page orientation
- Create a booklet
- Scale a document to fit a specific paper size

- Print the first or last pages of the document on different paper
- Print watermarks on a document

Store print jobs on the printer to print later or print privately

Introduction

The following information provides procedures for creating and printing documents that are stored on the printer. These jobs can be printed at a later time or printed privately.

- [Create a stored job \(Windows\)](#)
- [Create a stored job \(OS X\)](#)
- [Print a stored job](#)
- [Delete a stored job](#)
- [Information sent to printer for Job Accounting purposes](#)

Create a stored job (Windows)

Store jobs on the printer for private or delayed printing.

 **NOTE:** The print driver might look different than what is shown here, but the steps are the same.

1. From the software program, select the **Print** option.
2. Select the printer from the list of printers, and then select **Properties** or **Preferences** (the name varies for different software programs).

 **NOTE:** The name of the button varies for different software programs.

 **NOTE:** To access these features from a Windows 8 or 8.1 Start screen app, select **Devices**, select **Print**, and then select the printer.

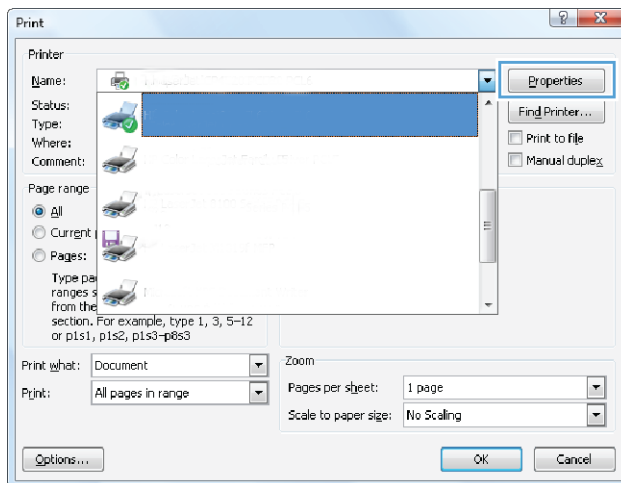

3. Click the **Job Storage** tab.

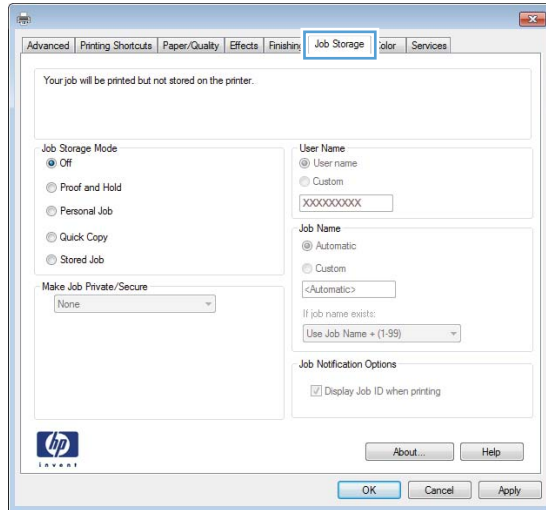

4. Select a **Job Storage Mode** option.

- **Proof and Hold:** Print and proof one copy of a job, and then print more copies.
- **Personal Job:** The job does not print until you request it at the printer control panel. For this job-storage mode, you can select one of the **Make Job Private/Secure** options. If you assign a personal identification number (PIN) to the job, you must provide the required PIN at the control panel. If you encrypt the job, you must provide the required password at the control panel. The print job is deleted from memory after it prints and is lost if the printer loses power.
- **Quick Copy:** Print the requested number of copies of a job and store a copy of the job in the printer memory so you can print it again later.
- **Stored Job:** Store a job on the printer and allow other users to print the job at any time. For this job-storage mode, you can select one of the **Make Job Private/Secure** options. If you assign a personal identification number (PIN) to the job, the person who prints the job must provide the required PIN at the control panel. If you encrypt the job, the person who prints the job must provide the required password at the control panel.

5. To use a custom user name or job name, click the **Custom** button, and then enter the user name or the job name.

Select which option to use if another stored job already has that name:

- **Use Job Name + (1-99):** Append a unique number to the end of the job name.
- **Replace Existing File:** Overwrite the existing stored job with the new one.

6. Click the **OK** button to close the **Document Properties** dialog box. In the **Print** dialog box, click the **Print** button to print the job.

7. For information about how to print the job, see the topic for "Print a stored job."

Create a stored job (OS X)

Store jobs on the printer for private or delayed printing.

1. Click the **File** menu, and then click the **Print** option.
2. In the **Printer** menu, select the printer.
3. By default, the print driver displays the **Copies & Pages** menu. Open the menus drop-down list, and then click the **Job Storage** menu.
4. In the **Mode** drop-down list, select the type of stored job.
 - **Proof and Hold:** Print and proof one copy of a job, and then print more copies.
 - **Personal Job:** The job does not print until someone requests it at the printer control panel. If the job has a personal identification number (PIN), provide the required PIN at the control panel. The print job is deleted from memory after it prints and is lost if the printer loses power.
 - **Quick Copy:** Print the requested number of copies of a job and store a copy of the job in the printer memory to print it again later.
 - **Stored Job:** Store a job on the printer and allow other users to print the job at any time. If the job has a personal identification number (PIN), the person who prints the job must provide the required PIN at the control panel.
5. To use a custom user name or job name, click the **Custom** button, and then enter the user name or the job name.

Select which option to use if another stored job already has that name.

- **Use Job Name + (1-99):** Append a unique number to the end of the job name.
 - **Replace Existing File:** Overwrite the existing stored job with the new one.
6. If you selected the **Stored Job** or **Personal Job** option in step 3, you can protect the job with a PIN. Type a 4-digit number in the **Use PIN to Print** field. When other people attempt to print this job, the printer prompts them to enter this PIN number.
 7. Click the **Print** button to process the job.

Print a stored job

Use the following procedure to print a job that is stored in the printer memory.

1. From the Home screen on the printer control panel, select **Print**.
2. Select **Print from Job Storage**
3. Select **Choose**, and then select the name of the folder where the job is stored.
4. Select the name of the job. If the job is private or encrypted, enter the PIN or password.
5. To adjust the number of copies, select the number of copies field in the bottom-left corner of the screen. Use the keypad to enter the number of copies to print.
6. Select **Print** to print the job.

Delete a stored job

When a new job is stored in the printer memory, the printer overwrites any previous jobs with the same user and job name. If a job is not already stored under the same user and job name, and the printer needs additional space, the printer might delete other stored jobs starting with the oldest. To change the number of jobs that the printer can store, complete the following procedure:

1. From the Home screen on the printer control panel, open the [Settings](#) menu.
2. Open the following menus:
 - [Copy/Print or Print](#)
 - [Manage Stored Jobs](#)
 - [Temporary Job Storage Limit](#)
3. Use the keypad to enter the number of jobs that the printer stores.
4. Select [Done](#) to save the setting.

Use the following procedure to delete a job that is stored in the printer memory.

1. From the Home screen on the printer control panel, select [Print](#).
2. Select [Print from Job Storage](#).
3. Select [Choose](#), and then select the name of the folder where the job is stored.
4. Select the name of the job. If the job is private or encrypted, enter the PIN or password.
5. Select the Trash  icon to delete the job.

Information sent to printer for Job Accounting purposes

Printing jobs sent from drivers on the client (e.g., PC) may send personally identifiable information to HP's Printing and Imaging devices. This information may include, but is not limited to, user name and client name from which the job originated that may be used for job accounting purposes, as determined by the Administrator of the printing device. This same information may also be stored with the job on the mass storage device (e.g., disk drive) of the printing device when using the job storage feature.

Mobile printing

Introduction

HP offers multiple mobile and ePrint solutions to enable easy printing to an HP printer from a laptop, tablet, smartphone, or other mobile device. To see the full list and to determine the best choice, go to www.hp.com/go/LaserJetMobilePrinting.



NOTE: Update the printer firmware to ensure all mobile printing and ePrint capabilities are supported.

- [Wireless Direct Print and NFC Printing](#)
- [HP ePrint via email](#)
- [HP ePrint software](#)
- [AirPrint](#)
- [Android embedded printing](#)

Wireless Direct Print and NFC Printing

HP provides Wireless Direct Print and NFC (Near Field Communication) printing for printers with a supported HP Jetdirect 3000w NFC/Wireless Accessory. This accessory is available as an option for HP LaserJet printers that include a hardware-integration pocket (HIP).

Wireless Direct Print and NFC printing enable Wi-Fi capable (mobile) devices to make a wireless network connection directly to the printer without using a wireless router.

The printer does not need to be connected to the network for this mobile walk-up printing to work.





Use Wireless Direct Print to print wirelessly from the following devices:

- iPhone, iPad, or iPod touch using Apple AirPrint or the HP ePrint app
- Android mobile devices using the HP ePrint App or the Android embedded print solution
- PC and Mac devices using the HP ePrint Software

For more information on wireless printing, go to www.hp.com/go/wirelessprinting.

NFC and Wireless Direct Print capabilities can be enabled or disabled from the printer control panel.

1. From the Home screen on the printer control panel, open the [Settings](#) menu.
2. Open the following menus:
 - [Networking](#)
 - [Wireless Direct](#)
 - [Status](#)
3. Select [On](#), and then select [OK](#) to enable wireless printing.

 **NOTE:** In environments where more than one model of the same printer is installed, it might be helpful to provide each printer a unique Wireless Direct Name for easier printer identification for HP Wireless Direct printing. The Wireless network names, e.g., Wireless, WiFi Direct, etc. are available on the Information screen by selecting the Information  icon, and then selecting the Network  icon or the Wireless  icon.

Complete the following procedure to change the printer Wireless Direct name:

1. From the Home screen on the printer control panel, open the [Settings](#) menu.
2. Open the following menus:
 - [Networking](#)
 - [Wireless Direct](#)
 - [Wireless Direct Name](#)
3. Use the keypad to change the name in the [Wireless Direct Name](#) text field. Select **OK**.



HP ePrint via email

Use HP ePrint to print documents by sending them as an email attachment to the printer's email address from any email enabled device.

To use HP ePrint, the printer must meet these requirements:

- The printer must be connected to a wired or wireless network and have Internet access.
- HP Web Services must be enabled on the printer, and the printer must be registered with HP Connected.

Follow this procedure to enable HP Web Services and register with HP Connected:

1. Open the HP Embedded Web Server (EWS):
 - a. From the Home screen on the printer control panel, touch the Information  icon, and then touch the Network  icon to display the IP address or host name.
 - b. Open a web browser, and in the address line, type the IP address or host name exactly as it displays on the printer control panel. Press the **Enter** key on the computer keyboard. The EWS opens.

 <https://10.10.XXXX/>

 **NOTE:** If the web browser displays a message indicating that accessing the website might not be safe, select the option to continue to the website. Accessing this website will not harm the computer.

2. Click the **HP Web Services** tab.
3. Select the option to enable Web Services.

 **NOTE:** Enabling Web Services might take several minutes.

4. Go to www.hpconnected.com to create an HP ePrint account and complete the setup process.

HP ePrint software

The HP ePrint software makes it easy to print from a Windows or Mac desktop or laptop computer to any HP ePrint-capable printer. This software makes it easy to find HP ePrint-enabled printers that are registered to your HP Connected account. The target HP printer can be located in the office or at locations across the globe.

- **Windows:** After installing the software, open the **Print** option from within your application, and then select **HP ePrint** from the installed printers list. Click the **Properties** button to configure print options.
- **OS X:** After installing the software, select **File, Print**, and then select the arrow next to **PDF** (in the bottom left of the driver screen). Select **HP ePrint**.

For Windows, the HP ePrint software supports TCP/IP printing to local network printers on the network (LAN or WAN) to products that support UPD PostScript®.

Windows and OS X both support IPP printing to LAN or WAN network-connected products that support ePCL.

Windows and OS X also both support printing PDF documents to public print locations and printing using HP ePrint via email through the cloud.

Go to www.hp.com/go/eprintsoftware for drivers and information.

 **NOTE:** For Windows, the name of the HP ePrint Software print driver is HP ePrint + JetAdvantage.

 **NOTE:** The HP ePrint software is a PDF workflow utility for OS X, and is not technically a print driver.

 **NOTE:** HP ePrint Software does not support USB printing.

AirPrint

Direct printing using Apple's AirPrint is supported for iOS and from Mac computers running OS X 10.7 Lion and newer. Use AirPrint to print directly to the printer from an iPad, iPhone (3GS or later), or iPod touch (third generation or later) in the following mobile applications:

- Mail
- Photos
- Safari
- iBooks
- Select third-party applications

To use AirPrint, the printer must be connected to the same network (sub-net) as the Apple device. For more information about using AirPrint and about which HP printers are compatible with AirPrint, go to www.hp.com/go/LaserJetMobilePrinting.

 **NOTE:** Before using AirPrint with a USB connection, verify the version number. AirPrint versions 1.3 and earlier do not support USB connections.

Android embedded printing

HP's built-in print solution for Android and Kindle enables mobile devices to automatically find and print to HP printers that are either on a network or within wireless range for Wi-Fi Direct printing.

The printer must be connected to the same network (sub-net) as the Android device.

The print solution is built into the many versions of the operating system.

 **NOTE:** If printing is not available on your device, go to the [Google Play > Android apps](https://play.google.com/store/apps/details?id=com.hp.printservice) and install the HP Print Service Plugin.

For more information on how to use Android embedded printing and which Android devices are supported, go to www.hp.com/go/LaserJetMobilePrinting.

Print from the USB port

Introduction

This printer features easy-access USB printing, for quickly printing files without sending them from a computer. The printer accepts standard USB flash drives in the USB port near the control panel. It supports the following types of files:

- .pdf
- .prn
- .pcl
- .ps
- .cht



Enable the USB port for printing

The USB port is disabled by default. Before using this feature, enable the USB port. Use one of the following methods to enable the port:

Method one: Enable the USB port from the printer control-panel menus

1. From the Home screen on the printer control panel, swipe until the **Settings** menu displays. Touch the **Settings** icon to open the menu.
2. Open the following menus:
 - **USB Settings**
 - **Print From USB Drive Settings**
 - **Enable Print From USB Drive**
3. Select the **Enabled** option.

Method two: Enable the USB port from the HP Embedded Web server (network-connected printers only)

1. Open the HP Embedded Web Server (EWS):
 - a. From the Home screen on the printer control panel, touch the Information  icon, and then touch the Network  icon to display the IP address or host name.
 - b. Open a web browser, and in the address line, type the IP address or host name exactly as it displays on the printer control panel. Press the **Enter** key on the computer keyboard. The EWS opens.

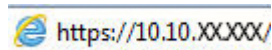

 **NOTE:** If the web browser displays a message indicating that accessing the website might not be safe, select the option to continue to the website. Accessing this website will not harm the computer.

2. Open the **Copy/Print** tab.
3. On the left side of the screen, click **Retrieve from USB Setup**.

4. Select the **Enable Retrieve from USB** check box.
5. Click **Apply**.

Print USB documents

1. Insert the USB flash drive into the easy-access USB port.



NOTE: The port might be covered. For some printers, the cover flips open. For other printers, pull the cover straight out to remove it.

2. From the Home screen on the printer control panel, select **Print**.
3. Select **Print from USB Drive**.
4. Touch **Choose**, and then select the name of the document to print. Touch **Select**.



NOTE: The document might be in a folder. Open folders as necessary.

5. To adjust the number of copies, touch the number of copies field in the bottom-left corner of the screen. Use the keypad to enter the number of copies to print.
6. Select **Print** to print the document.

5 Copy

- [Make a copy](#)
- [Copy on both sides \(duplex\)](#)
- [Additional options when copying](#)
- [Additional copy tasks](#)

For more information:

The following information is correct at the time of publication. For current information, see www.hp.com/support/ljM631MFP, www.hp.com/support/ljM632MFP, or www.hp.com/support/ljM633MFP.

HP's all-inclusive help for the printer includes the following information:

- Install and configure
- Learn and use
- Solve problems
- Download software and firmware updates
- Join support forums
- Find warranty and regulatory information

Make a copy

1. Place the document face-down on the scanner glass, or place it face-up in the document feeder and adjust the paper guides to fit the size of the document.
2. From the Home screen on the printer control panel, select [Copy](#).
3. In the [Options](#) pane, select the number of copies.
4. Select [Optimize Text/Picture](#) to optimize for the type of image being copied: text, graphics, or photos. Select one of the predefined options.
5. Set options marked with a yellow triangle before using the preview feature.

 **NOTE:** After the preview scan, these options are removed from the main [Options](#) list and are summarized in the [Pre-scan Options](#) list. To change any of these options, discard the preview and start over.

Using the preview feature is optional.

6. Touch the right pane of the screen to preview the document. In the preview screen, use the buttons on the right of the screen to adjust the preview options and to rearrange, rotate, insert, or remove pages.



Use these buttons to toggle between two-page view and thumbnail view. More options are available in thumbnail view than in two-page view.



Use these buttons to zoom in or out on the selected page.

NOTE: Select only one page at a time to use these buttons.



Use this button to rotate the page 180 degrees.

NOTE: This button is available only in the thumbnail view.



Use this button to delete the selected pages.

NOTE: This button is available only in the thumbnail view.



Use these buttons to rearrange the pages within the document. Select one or more pages and move them to the left or right.

NOTE: These buttons are available only in the thumbnail view.





Use this button to add a page to the document. The printer prompts to scan additional pages.



Use this button to clear the changes made in the preview and start over.



Touch this button to collapse the preview screen and return to the Copy screen.

7. When the document is ready, touch [Start](#) to begin copying.

Copy on both sides (duplex)

1. Place the document face-down on the scanner glass, or place it face-up in the document feeder and adjust the paper guides to fit the size of the document.
2. From the Home screen on the printer control panel, select [Copy](#).
3. In the [Options](#) pane, select [Sides](#).
4. Select [Original Sides](#), and then select the option that describes the original document:

- Use [Automatically detect](#) to detect whether the original is printed on one or both sides of the page.



NOTE: This feature is not available for all firmware versions. You might need to update the printer firmware to use this feature.

- Use [1-sided](#) for originals that are printed on one side of the page.
 - Use [2-sided](#) for originals that are printed on both sides of the page.
 - Enable or disable [Pages Flip Up](#) to determine on which edge of the page a 2-sided original flips.
5. Select [Output Sides](#), and then select one of these options:
 - [Match original](#): The output will match the format of the original. For example, if the original is 1-sided, the output will be 1-sided. However, if the administrator has restricted 1-sided printing and the original is 1-sided, the output will be 2-sided book-style.



NOTE: This feature is not available for all firmware versions. You might need to update the printer firmware to use this feature.

- [1-sided](#): The output will be 1-sided. However, if the administrator has restricted 1-sided printing, the output will be 2-sided book-style.
 - [2-sided](#): The output will be 2-sided.
 - Enable or disable [Pages Flip Up](#) to determine on which edge of the page the 2-sided output flips.
6. Set options marked with a yellow triangle before using the preview feature.



NOTE: After the preview scan, these options are removed from the main [Options](#) list and are summarized in the [Pre-scan Options](#) list. To change any of these options, discard the preview and start over.

Using the preview feature is optional.

7. Touch the right pane of the screen to preview the document. In the preview screen, use the buttons on the right of the screen to adjust the preview options and to rearrange, rotate, insert, or remove pages.



Use these buttons to toggle between two-page view and thumbnail view. More options are available in thumbnail view than in two-page view.





Use these buttons to zoom in or out on the selected page.

NOTE: Select only one page at a time to use these buttons.



Use this button to rotate the page 180 degrees.

NOTE: This button is available only in the thumbnail view.



Use this button to delete the selected pages.

NOTE: This button is available only in the thumbnail view.



Use these buttons to rearrange the pages within the document. Select one or more pages and move them to the left or right.

NOTE: These buttons are available only in the thumbnail view.



Use this button to add a page to the document. The printer prompts to scan additional pages.



Use this button to clear the changes made in the preview and start over.



Touch this button to collapse the preview screen and return to the Copy screen.

8. When the document is ready, touch [Start](#) to begin copying.

Additional options when copying

The following settings are available in the [Options](#) list when copying.



NOTE: The following list contains the master set of options available for HP LaserJet Enterprise MFP printers. Some options are not available on all printers.

Number of Copies	Specify the number of copies to make.
Load and Save Settings	<p>Load Quick Set: Load copy settings from a saved Quick Set.</p> <p>NOTE: Use the HP Embedded Web Server to create and save Quick Sets.</p> <p>Save Defaults: Save the current settings in the Options list as default settings for future copy jobs.</p>
Sides	Specify whether the original document is printed on one side or both sides, and whether the copies are to be printed on one side or both sides.
Color/Black	Specify whether copies are to be printed in color, black and gray, or black only.
For color printers only.	
Staple	Specify the placement of staples.
For printers with automatic finishing accessories only. This feature does not apply to printers with convenience staplers.)	
Staple/Hole Punch	Specify the number and placement of punched holes.
For printers with hole-punch accessories only.	
Scan Mode	<p>Standard Document: Scan a page or stack of pages through the document feeder, or individually on the flatbed glass.</p> <p>Book Mode: Scan an open book and output each page of the book onto different pages.</p> <p>2-sided ID Copy: Scan each side of an identification card on the flatbed glass and output them onto one page. After scanning the first side, the printer prompts to place the second side in the correct position on the glass.</p>
Reduce/Enlarge	Scale the size of the scanned document up or down.
Original Size	Specify the paper size for the original document.
Paper Selection	Specify the paper size and type for the copies.
Booklet	Format and rearrange original scanned images into pages that print as a booklet.
Content Orientation	Specify whether the original document is printed in Portrait or Landscape orientation.
Pages per Sheet	Copy multiple sheets of paper onto a single sheet. Select one, two, or four pages per sheet.
Output Bin	Specify which output bin to use for the job when the printer output bins are configured for mailbox mode.
For printers with multiple output bins only.	
NOTE: This option does not appear when the output bins are configured for stacker mode or function-separator mode.	

<p>Paper Path</p> <p>For printers that have an option to flip pages inside the paper path.</p>	<p>Select a specific paper path:</p> <p>Face-up (straightest path): Pages output to the bin in the opposite order that they were placed in the document feeder.</p> <p>Face-down (correct order): Pages are stacked in the same order as they were placed in the document feeder.</p>
<p>Image Adjustment</p>	<p>Sharpness: Clarify or soften the image. For example, increasing the sharpness could make text appear crisper, but decreasing it could make photos appear smoother.</p> <p>Darkness: Increase or decrease the amount of white and black used in colors in scanned images.</p> <p>Contrast: Increase or decrease the difference between the lightest and the darkest color on the page.</p> <p>Background Cleanup: Remove faint colors from the background of scanned images. For example, if the original document is printed on colored paper, use this feature to lighten the background without affecting the darkness of the image.</p> <p>Automatic Tone: Available for Flow printers only. For original documents that have at least 100 characters of text on the page, the printer can detect which edge is the top of the page, and it orients the scanned images appropriately. If some of the pages are upside-down in relation to the other pages, the resulting scanned image has all pages right-side-up. If some of the pages have a landscape orientation, the printer rotates the image so that the top of the page is at the top of the image.</p>
<p>Optimize Text/Picture</p>	<p>Optimize the job for the type of image being scanned: text, graphics, or photos.</p>
<p>Edge-to-Edge</p>	<p>Scan and print a copy closer to the edge of the page than is normally allowed. Printing close to the edge can result in some print-quality issues.</p>
<p>Erase Edges</p>	<p>Remove blemishes, such as dark borders or staple marks, by cleaning the edges of the scanned image.</p>
<p>Collate</p>	<p>Assemble each set of pages in the same order as the original document when making multiple copies of a document.</p>
<p>Automatically Straighten</p> <p>NOTE: Available on Flow models only.</p> <p>This feature is not available for all firmware versions. You might need to update the printer firmware to use this feature.</p>	<p>Automatically straighten a scanned image.</p>
<p>Blank Page Suppression</p> <p>NOTE: This feature is not available for all firmware versions. You might need to update the printer firmware to use this feature.</p>	<p>Exclude blank pages in the original document from scanned images. This feature is useful for scanning pages printed on both sides to eliminate blank pages in the resulting scanned document.</p>
<p>Multi-feed Detection</p>	<p>Enable or disable multi-feed detection. When enabled, scanning stops when the printer detects more than one page at a time being fed in the document feeder. When disabled, scanning continues when a multi-feed is detected, to allow scanning pages that are stuck together, originals with self-adhesive notes on them, or thick paper.</p>

Additional copy tasks

Go to www.hp.com/support/ljM631MFP, www.hp.com/support/ljM632MFP, or www.hp.com/support/ljM633MFP.

Instructions are available for performing specific copy tasks, such as the following:

- Copy or scan pages from books or other bound documents
- Copy mixed-size documents
- Copy or scan both sides of an identification card
- Copy or scan a document into a booklet format

6 Scan

- [Set up Scan to Email](#)
- [Set up Scan to Network Folder](#)
- [Set up Scan to USB Drive](#)
- [Set up Save to SharePoint® \(Flow models only\)](#)
- [Create a Quick Set](#)
- [Send a scanned document to one or more email addresses](#)
- [Scan and send to network folder](#)
- [Scan and send to USB Flash Drive](#)
- [Additional options when scanning](#)
- [HP JetAdvantage business solutions](#)
- [Additional scan tasks](#)

For more information:

The following information is correct at the time of publication. For current information, see www.hp.com/support/ljM631MFP, www.hp.com/support/ljM632MFP, or www.hp.com/support/ljM633MFP.

HP's all-inclusive help for the printer includes the following information:

- Install and configure
- Learn and use
- Solve problems
- Download software and firmware updates
- Join support forums
- Find warranty and regulatory information

Set up Scan to Email

- [Introduction](#)
- [Before you begin](#)
- [Step one: Access the HP Embedded Web Server \(EWS\)](#)
- [Step two: Configure the Network Identification settings](#)
- [Step three: Configure the Send to Email feature](#)
- [Step four: Configure the Quick Sets \(optional\)](#)
- [Step five: Set up Send to Email to use Office 365 Outlook \(optional\)](#)

Introduction

The printer has a feature that enables it to scan a document and send it to one or more email addresses. To use this scan feature, the printer must be connected to a network; however, the feature is not available until it has been configured. There are two methods for configuring Scan to Email, the **Scan to Email Setup Wizard** for basic and **Email Setup** for advanced. Use the following information to set up the Scan to Email feature.

Before you begin

To set up the Scan to Email feature, the printer must have an active network connection.

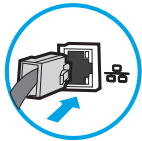

Administrators need the following information before beginning the configuration process.



- Administrative access to the printer
- DNS suffix (e.g., companyname.com)
- SMTP server (e.g., smtp.mycompany.com)

 **NOTE:** If you do not know the SMTP server name, SMTP port number, or authentication information, contact the email/Internet service provider or system administrator for the information. SMTP server names and port names are typically found by doing an Internet search. For example, use terms like "Gmail smtp server name" or "Yahoo smtp server name" to search.

- SMTP server authentication requirements for outgoing email messages, including the user name and password used for authentication, if applicable.

 **NOTE:** Consult your email service provider's documentation for information on digital sending limits for your email account. Some providers may temporarily lock your account if you exceed your sending limit.

Step one: Access the HP Embedded Web Server (EWS)

1. From the Home screen on the printer control panel, touch the Information  icon, and then touch the Network  icon to display the IP address or host name.

- Open a web browser, and in the address line, type the IP address or host name exactly as it displays on the printer control panel. Press the **Enter** key on the computer keyboard. The EWS opens.

 <https://10.10.XX.XXX/>

 **NOTE:** If the web browser displays a message indicating that accessing the website might not be safe, select the option to continue to the website. Accessing this website will not harm the computer.

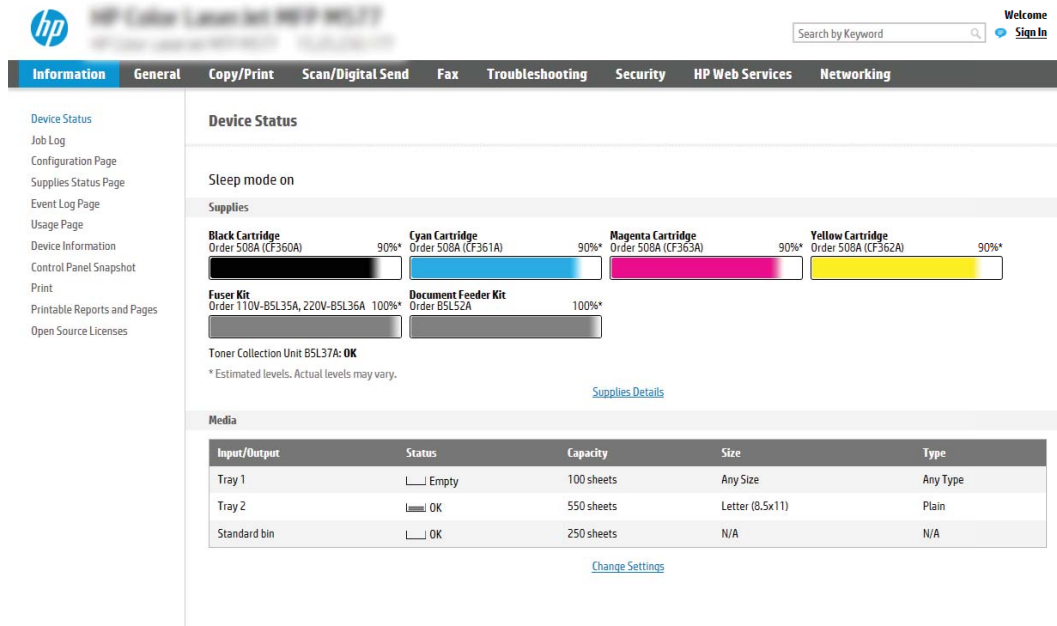

Supplies

Black Cartridge	Cyan Cartridge	Magenta Cartridge	Yellow Cartridge
Order 508A (CF360A) 90%*	Order 508A (CF361A) 90%*	Order 508A (CF363A) 90%*	Order 508A (CF362A) 90%*

Fuser Kit Order 110V-B5L35A, 220V-B5L36A 100%* **Document Feeder Kit** Order B5L52A 100%*

Toner Collection Unit B5L37A: **OK**

* Estimated levels. Actual levels may vary.

[Supplies Details](#)

Media

Input/Output	Status	Capacity	Size	Type
Tray 1	Empty	100 sheets	Any Size	Any Type
Tray 2	OK	550 sheets	Letter (8.5x11)	Plain
Standard bin	OK	250 sheets	N/A	N/A

[Change Settings](#)

Step two: Configure the Network Identification settings

 **NOTE:** Configuring email setup on the **Networking** tab is an advanced process and might require the assistance of a system administrator.

- Using the EWS top navigation tabs, click **Networking**.

 **NOTE:** For configuring the network settings for use with Office 365, [Step five: Set up Send to Email to use Office 365 Outlook \(optional\) on page 93](#)

- In the left navigation pane, click **TCP/IP Settings**. A username/password might be required to access the **Network Identification** tab of the EWS.
- On the **TCP/IP Settings** dialog, click the **Network Identification** tab.

4. If DNS is required on the network, in the **TCP/IP Domain Suffix** area, verify that the DNS suffix for the email client being used is listed. DNS suffixes have this format: *companyname.com*, gmail.com, etc.

 **NOTE:** If the Domain Name suffix is not set up, use the IP address.

5. Click **Apply**.
6. Click **OK**.

Step three: Configure the Send to Email feature

The two options for configuring Send to Email are the **Email Setup Wizard** for basic configuration and **Email Setup** for advanced configuration. Use the following options to configure the Send to Email feature:

- [Method one: Basic configuration using the Email Setup Wizard](#)
- [Method two: Advanced configuration using the Email Setup](#)

Method one: Basic configuration using the Email Setup Wizard

This option opens the **Email Setup Wizard** in the HP Embedded Web Server (EWS) for basic configuration.

1. Using the EWS top navigation tabs, click **Scan/Digital Send**.
2. In the left-navigation pane, click **Email and Scan to Network Folder Quick Setup Wizards**.

3. In the **Email and Scan to Network Folder Quick Setup Wizards** dialog, click the **Email Setup** link.

 **NOTE:** If a message displays indicating that the Scan to Email feature is disabled, click **Continue** to proceed with the configuration and enable the Scan to Email feature upon completion.

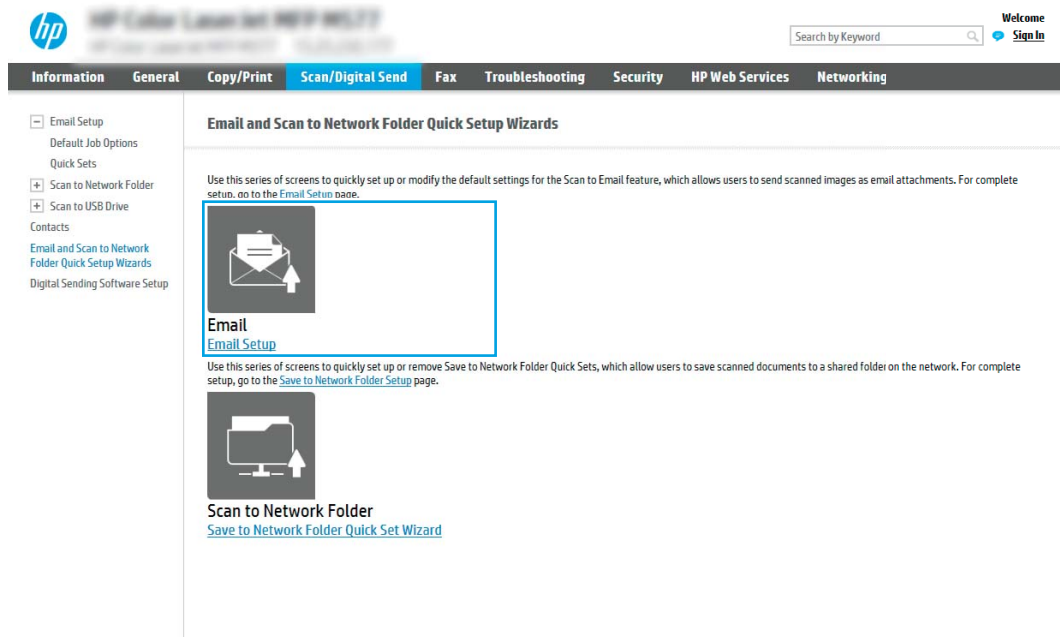

4. On the **Configure Email Servers (SMTP)** dialog, select one of the following options and complete the steps:

Option one: Use a server already in use by Email

- ▲ Select **Use a server already in use by Email**, and then click **Next**.

Option two: Search network for outgoing email server

 **NOTE:** This option finds outgoing SMTP servers inside your firewall only.

- Select **Search network for outgoing email server**, and then click **Next**.
- Select the appropriate server from the **Configure Email Server (SMTP)** list, and then click **Next**.
- Select the option that describes the server's authentication requirements:
 - **Server does not require authentication:** Select **Server does not require authentication**, and then click **Next**.
–OR–
 - **Server requires authentication:** From the drop-down list, select an authentication option:
 - **Use credentials of user to connect after Sign In at the control panel:** Select **Use credentials of user to connect after Sign In at the control panel**, and then click **Next**.
–OR–
 - **Always use these credentials:** Select **Always use these credentials**, enter the **User name** and **Password**, and then click **Next**.

Option three: Add SMTP server

- a. Select **Add SMTP server**
- b. Enter the **Server Name** and **Port Number**, and then click **Next**.

 **NOTE:** In most cases, the default port number does not need to be changed.

 **NOTE:** If you are using a hosted SMTP service such as Gmail, verify the SMTP address, port number, and SSL settings from the service provider's website or other sources. Typically, for Gmail, the SMTP address is smtp.gmail.com, port number 465, and the SSL should be enabled.

Please refer to online sources to confirm these server settings are current and valid at the time of configuration.

- c. Select the appropriate server authentication option:
 - **Server does not require authentication:** Select **Server does not require authentication**, and then click **Next**.
 - OR–
 - **Server requires authentication:** Select an option from the **Server requires authentication** drop-down list:
 - **Use credentials of user to connect after Sign In at the control panel:** Select **Use credentials of user to connect after Sign In at the control panel**, and then click **Next**.
 - OR–
 - **Always use these credentials:** Select **Always use these credentials**, enter the **User name** and **Password**, and then click **Next**.
5. On the **Configure Email Settings** dialog, enter the following information about for the sender's email address, and then click **Next**.

 **NOTE:** When setting up the **From**, **Subject**, and **Message** fields, if the **User editable** check box is unchecked, users will not be able to edit those fields at the printer control panel when sending an email.

Option	Description
From (Required)	Select one of the following options from the From drop-down list: <ul style="list-style-type: none">• User's address (sign-in required)• Default From: Enter a default email address and display name in the Default From Email Address and Default Display Name fields <p>NOTE: Create an email account for the printer, and use this address for the default email address.</p> <p>NOTE: Configure the email feature so that users must sign in before using it. This prevents users from sending an email from an address that is not their own.</p>

Option	Description
Subject (Optional)	Provide a default subject line for the email messages.
Message (Optional)	Create a custom message. To use this message for all emails sent from the printer, clear the User editable check box for Message .

6. In the **Configure File Scan Settings** area, set the default scanning preferences, and then click **Next**.

Option	Description
File Type	Select the default file type that the for the scanned document: <ul style="list-style-type: none"> • PDF • JPEG • TIFF • MTIFF • XPS • PDF/A
Color/Black	Select the default color setting for the scanned document: <ul style="list-style-type: none"> • Color • Black • Black/Gray • Automatically detect
Quality and File Size	Select the default output quality for the scanned document: <ul style="list-style-type: none"> • Low (small file) • Medium • High (large file)
Resolution	Select the default scan resolution for the scanned document: <ul style="list-style-type: none"> • 75 dpi • 150 dpi • 200 dpi • 300 dpi • 400 dpi • 600 dpi

7. Review the **Summary** area, and then click **Finish** to complete the setup.

Method two: Advanced configuration using the Email Setup

1. Using the EWS top navigation tabs, click **Scan/Digital Send**, and then click **Email Setup** in the left navigation pane.

 **NOTE:** By default, the Email Setup page displays the basic settings for Scan to Email setup. To access additional settings, click the **Advanced Settings** button at the bottom of the page.

2. On the **Email Setup** dialog, select the **Enable Send to Email** check box. If this check box is not selected, the feature is unavailable at the printer control panel.

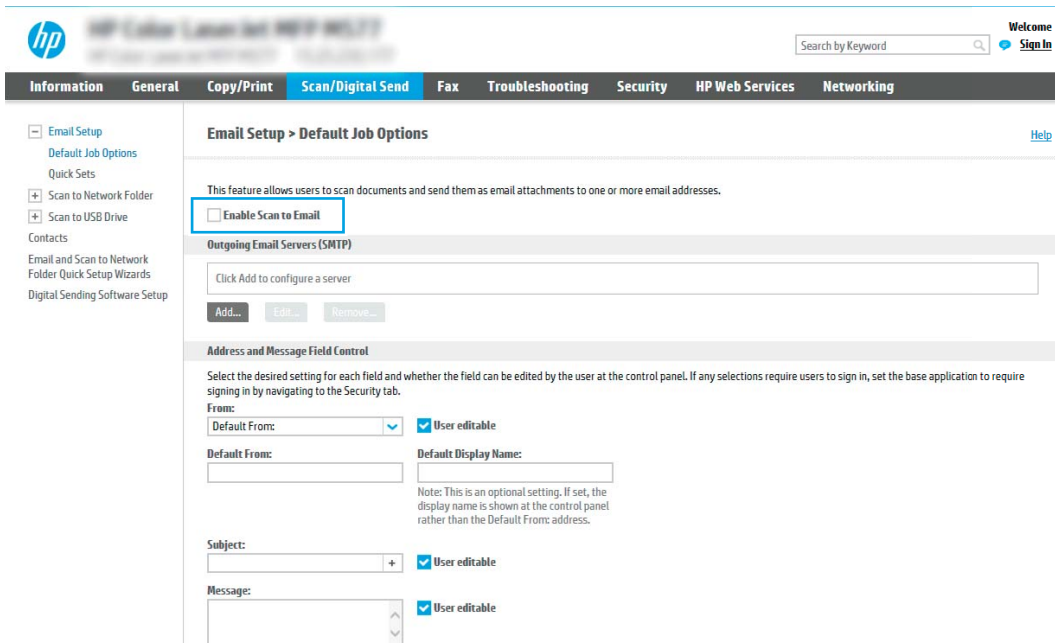



The screenshot shows the HP EWS interface for the 'Email Setup > Default Job Options' page. The 'Scan/Digital Send' tab is active. In the left navigation pane, 'Email Setup' is expanded, and 'Default Job Options' is selected. The main content area shows a section titled 'Email Setup > Default Job Options' with a 'Help' link. Below this, a text box states: 'This feature allows users to scan documents and send them as email attachments to one or more email addresses.' A checkbox labeled 'Enable Scan to Email' is checked. Below this is the 'Outgoing Email Servers (SMTP)' section, which includes a text box for adding a server and 'Add...', 'Edit...', and 'Remove...' buttons. The 'Address and Message Field Control' section allows users to configure fields for 'From:', 'Subject:', and 'Messages:'. Each field has a 'User editable' checkbox, which is checked for all three. The 'Default From:' field has a dropdown menu and a text input. The 'Default Display Name:' field has a text input. A note below this section states: 'Note: This is an optional setting. If set, the display name is shown at the control panel rather than the Default From: address.'

3. In the **Outgoing Email Servers (SMTP)** area, complete the steps for one of the following options:
 - Select one of the displayed servers
 - Click **Add** to start the SMTP wizard.
 1. In the SMTP wizard, select one of the following options:
 - **Option one: I know my SMTP server address or host name:** Enter the address of an SMTP server, and then click **Next**
 - **Option two:** If you do not know the address of the SMTP server, select **Search network for outgoing email server**, and then click **Next**. Select the server, and then click **Next**.

 **NOTE:** If an SMTP server was already created for another printer function, the **Use a server already in use by another function** option displays. Select this option, and then configure it to be used for the email function.

2. On the **Set the basic information necessary to connect to the server** dialog, set the options to use, and then click **Next**.

 **NOTE:** Some servers have problems sending or receiving emails that are larger than 5 megabytes (MB). These problems can be prevented by entering a number in **Split emails if larger than (MB)**.

 **NOTE:** In most cases, the default port number does not need to be changed. However, when using the Enable SMTP SSL Protocol option, port 587 must be used.

 **NOTE:** If you are using Google™ Gmail for email service, select the **Enable SMTP SSL Protocol** check box. Typically, for gmail, the SMTP address is smtp.gmail.com, port number 465, and the SSL should be enabled.

Please refer to online sources to confirm these server settings are current and valid at the time of configuration.

3. On the **Server Authentication Requirements** dialog, select the option that describes the server's authentication requirements:
 - **Server does not require authentication**, and then click **Next**.
 - **Server requires authentication**
 - From the drop-down box, select **Use credentials of user to connect after Sign In at the control panel**, and then click **Next**.
 - From the drop-down box, select **Always use these credentials**, enter the **Username** and **Password**, and then click **Next**.

 **NOTE:** If using a signed-in user's credentials, set email to require sign in by the user on the printer control panel. Deny device guest access to email by clearing the check box for email in the **Device Guest** column in the **Sign in and Permission Policies** area on the **Access Control** dialog of the **Security** tab. The icon in the check box changes from a check mark to a lock.

4. On the **Server Usage** dialog, choose the printer functions that will send email through this SMTP server, and then click the **Next** button.

 **NOTE:** If the server requires authentication, a user name and password for sending automatic alerts and reports from the printer will be required.

5. On the **Summary and Test** dialog, enter a valid email address in the **Send a test email to:** field, and then click **Test**.
6. Verify that all of the settings are correct, and then click **Finish** to complete the outgoing email server set up.

4. In the **Address and Message Field Control** area, enter a **From:** setting and any of the other optional settings.

Address and Message Field Control settings:

Feature	Description
Address Field Restrictions¹	<p>Specify whether users must select an email address from an address book or whether users are allowed to enter in an email address manually.</p> <p>CAUTION: If Users must select from address book is selected, and any of the address fields are also set as User editable, changes to those editable fields also change the corresponding values in the address book.</p> <p>To prevent users from changing contacts in the Address Book at the printer control panel, go to the Access Control page on the Security tab, and deny Device Guest access to address book modifications.</p>
Allow invalid email address formats¹	Select to allow an invalid email address format.
User editable	<p>To use the Default From address and Default Display Name for all emails sent from this printer (unless a user is signed in), do not select the User editable check box.</p> <p>When setting up the address fields, if the User editable check box is unchecked, users will not be able to edit those fields at the printer control panel when sending an email. For send-to-me functionality, clear the User editable check boxes for all of the address fields, including the From: To: CC:, and BCC: fields, and then set that user's send email From: their own email address and To: their own email address.</p>
Default From: and Default Display Name:	<p>Provide an email address and name to use for the From: address for the email message.</p> <p>NOTE: Create an email account for the printer, and use this address for the default email address.</p> <p>NOTE: Configure the email feature so that users must sign in before using it. This prevents users from sending an email from an address that is not their own.</p>
To:¹	Provide a To (recipient) email address for emails.
CC:¹	Provide a CC email address for emails.
BCC:¹	Provide a BCC email address for emails.
Subject:	Provide a default subject line for the email messages.
Message:	Create a custom message. To use this message for all emails sent from the printer, clear or do not select the User editable check box for Message: .

¹ This setting is available only on the Advanced Settings page.

5. In the **Signing and Encryption** area, set the signing and encryption preferences.



NOTE: These settings are available only on the Advanced Settings page.

Signing and Encryption settings:

Feature	Description
Signing	<p>Select whether to sign the security certificate.</p> <p>Select the User editable check box to make this setting editable at the printer control panel.</p>
Hashing Algorithm	Select the algorithm to use for signing the certificate.
Encryption	<p>Select whether to encrypt the email.</p> <p>Select the User editable check box to make this setting editable at the printer control panel.</p>
Encryption Algorithm	Select the algorithm to use for encrypting the email.

Feature	Description
Attribute for Recipient Public Key	Enter which attribute to use to retrieve the recipient's public key certificate from LDAP.
Use the recipient public key certificate to verify the recipient	Select this setting to use the recipient's public key certificate to verify the recipient.

- In the **Notification Settings** area, select when users will receive notifications about sent emails. The default setting is using the signed in user's email address. If the recipient email address is blank, no notification is sent.
- In the **Scan Settings** area, set the default scanning preferences.



NOTE: These settings are available only on the Advanced Settings page.

Scan settings:

Feature	Description
Original Size	Select the page size of the original document.
Original Sides	Select whether the original document is single-sided or double-sided.
Optimize Text/Picture	Select to optimize for the output of a particular type of content.
Content Orientation	Select the way the content of the original document is placed on the page: Portrait or Landscape .
Background Cleanup	Select a value to remove faint images from the background or to remove a light background color.
Darkness	Select a value to adjust the darkness of the file.
Contrast	Select a value to adjust the contrast of the file.
Sharpness	Select a value to adjust the sharpness of the file.
Image Preview	Select whether to require or make optional a displayed preview of the job or to disable a preview.
Cropping Options	Select whether or not to allow a job to be cropped and the type of cropping option.
Erase Edges	Select this setting to specify the width of edge margins to be erased, in either inches or millimeters, for the front side and back side of a job.

- In the **File Settings** area, set the default file settings preferences.

File settings:

Feature	Description
File Name Prefix ¹	Set the default file name prefix used for files saved to a network folder.
File Name	Default file name for the file to be saved. Select the User editable check box to make this setting editable at the printer control panel.
File Name Suffix ¹	Set the default file name suffix used for files saved to a network folder. Duplicate filename suffix default [filename]_YYYYMMDDT
File Name Preview ¹	Enter a file name, and then click the Update Preview button.
File Numbering Format ¹	Select a file name format for when the job is divided into multiple files.

Feature	Description
Add numbering when job has just one file (ex. _1-1) ¹	Select this setting to add numbering to a file name when the job is only one file instead of multiple files.
File Type	Select the file format for the saved file. Select the User editable check box to make this setting editable at the printer control panel.
High Compression (smaller file)	Select this setting to compress the scanned file, which reduces the file size. However, the scanning process for a High compression file might take longer than for a Normal compression file.
PDF encryption ¹	If the file type is PDF, then this option encrypts the output PDF file. A password must be specified as part of the encryption. The same password must be used to open the file. The user will be prompted to enter a password prior to scanning their job if one has not been set prior to pressing start.
Resolution	Set the resolution for the file. Higher resolution images have more dots per inch (dpi), so they show more detail. Lower resolution images have fewer dots per inch and show less detail, but the file size is smaller.
Quality and File Size	Select the quality for the file. Higher-quality images require a larger file size than lower-quality images, and they take more time to send.
Color/Black	Specify whether copies are to be printed in color, black and gray, or black only.
Suppress blank pages ¹	If the Suppress blank pages option is enabled, blank pages will be ignored.
Create Multiple Files ¹	Select this setting to scan pages into separate files based on a predetermined maximum number of pages per file.

¹ This setting is available only on the Advanced Settings page.

- Review the selected options to verify that they are accurate, and then click **Apply** to complete the setup.

Step four: Configure the Quick Sets (optional)

Quick Sets are optional short-cut jobs that can be accessed on the main Home screen or within the Quick Sets application at the printer.

- In the **Email Setup** area of the left navigation pane, click **Quick Sets**.
- Select one of the following options:
 - Select an existing Quick Set under Quick Sets Application in the table.
 - OR-
 - Click **Add** to start the Quick Set Wizard.
- If you selected **Add**, the **Quick Sets Setup** page opens. Complete the following information:
 - Quick Set Name:** Enter a title for the new Quick Set.
 - Quick Set Description:** Enter a description of the Quick Set.
 - Quick Set Start Option:** To set how the Quick Set starts, click either **Enter application, then user presses Start** or **Start instantly when selected from the Home Screen**.
- Define the following settings for the Quick Set: Address and Message Field Control, Signing and Encryption, Notification Settings, Scan Settings, File Settings.
- Click **Finish** to save the Quick Set.

Step five: Set up Send to Email to use Office 365 Outlook (optional)

Introduction

Microsoft Office 365 Outlook is a cloud-based email system provided by Microsoft which uses Microsoft's Simple Mail Transfer Protocol (SMTP) server to send or receive emails. Complete the following to enable the printer to send an email with an Office 365 Outlook account from the control panel.

 **NOTE:** You must have an email address account with Office 365 Outlook to configure the settings in the EWS.

Configure the outgoing email server (SMTP) to send an email from an Office 365 Outlook account

1. Using the EWS top navigation tabs, click **Networking**.
2. In the left navigation pane, click **TCP/IP Settings**.
3. In the **TCP/IP Settings** area, click the **Network Identification** tab.
4. If DNS is required on the network, in the **TCP/IP Domain Suffix** area, verify that the DNS suffix for the email client being used is listed. DNS suffixes have this format: *companyname.com*, Gmail.com, etc.

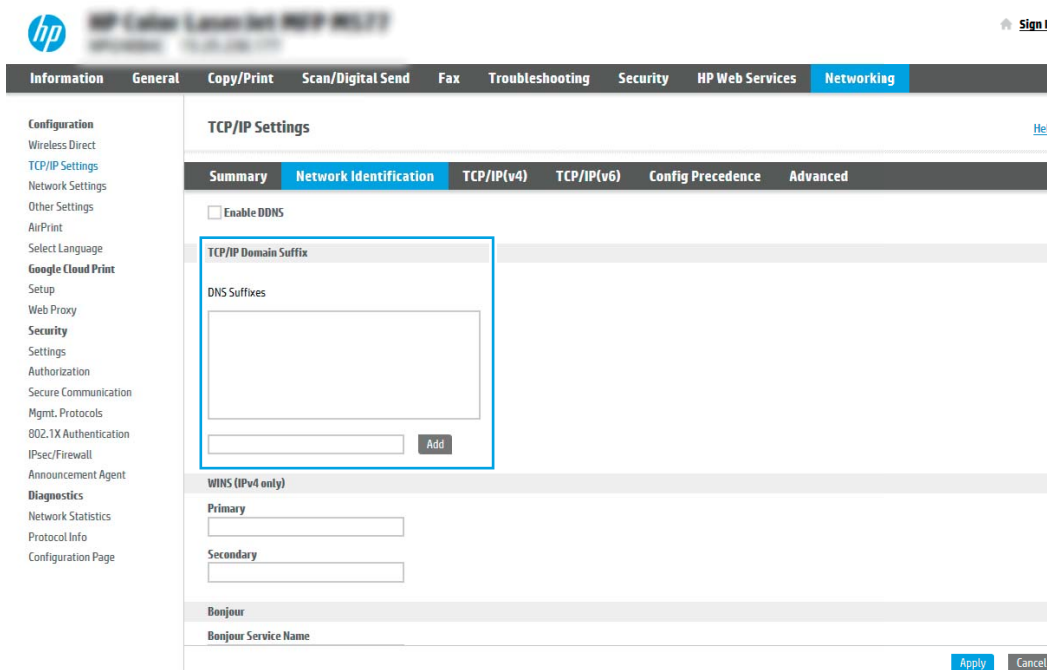

The screenshot shows the HP EWS interface for TCP/IP Settings. The 'Networking' tab is selected in the top navigation bar. The left navigation pane shows 'TCP/IP Settings' selected. The main content area is titled 'TCP/IP Settings' and has a sub-tab 'Network Identification' selected. Under 'Network Identification', there is a checkbox for 'Enable DDNS' which is unchecked. Below that is the 'TCP/IP Domain Suffix' section, which contains a 'DNS Suffixes' list and an 'Add' button. The 'WINS (IPv4 only)' section has 'Primary' and 'Secondary' input fields. The 'Bonjour' section has a 'Bonjour Service Name' input field. At the bottom right, there are 'Apply' and 'Cancel' buttons.

 **NOTE:** If the Domain Name suffix is not set up, use the IP address.

5. Click **Apply**.
6. Click the **Scan/Digital Send** tab.
7. On the left navigation pane, click **Email Setup**.

- On the **Email Setup** page, select the **Enable Send to Email** check box. If this check box is not available, the feature is unavailable at the printer control panel.

The screenshot shows the HP Email Setup interface. The top navigation bar includes 'Information', 'General', 'Copy/Print', 'Scan/Digital Send', 'Fax', 'Troubleshooting', 'Security', 'HP Web Services', and 'Networking'. The left sidebar lists 'Email Setup' with sub-options like 'Default Job Options', 'Quick Sets', 'Scan to Network Folder', and 'Scan to USB Drive'. The main content area is titled 'Email Setup > Default Job Options'. A red box highlights the 'Enable Scan to Email' checkbox. Below this is the 'Outgoing Email Servers (SMTP)' section with an 'Add...' button. The 'Address and Message Field Control' section includes fields for 'From:', 'Default From:', 'Subject:', and 'Message:', each with a 'User editable' checkbox.

- In the **Outgoing Email Servers (SMTP)** area, click **Add** to start the SMTP wizard.
- In the **I know my SMTP server address or host name** field, type smtp.onoffice.com, and then click **Next**.
- On the **Set the basic information necessary to connect to the server** dialog, in the **Port Number** field, type **587**.

 **NOTE:** Some servers have problems sending or receiving emails that are larger than 5 megabytes (MB). These problems can be prevented by entering a number in **Split emails if larger than (MB)**.

- Select the **Enable SMTP SSL Protocol** check box, and then click **Next**.
- On the **Server Authentication Requirements** dialog, complete the following information:
 - Select **Server requires authentication**.
 - From the drop-down list, select **Always use these credentials**
 - In the **Username** field, type the Office 365 Outlook email address.
 - In the **Password** field, type the Office 365 Outlook account password, and then click **Next**.
- On the **Server Usage** dialog, choose the printer functions that will send email through this SMTP server, and then click the **Next** button.
- On the **Summary and Test** dialog, enter a valid email address in the **Send a test email to:** field, and then click **Test**.
- Verify that all of the settings are correct, and then click **Finish** to complete the outgoing email server set up.

Set up Scan to Network Folder

- [Introduction](#)
- [Before you begin](#)
- [Step one: Access the HP Embedded Web Server](#)
- [Step two: Set up Scan to Network Folder](#)

Introduction

This document explains how to enable and configure the Scan to Network Folder function. The printer has a feature that enables it to scan a document and save it to a network folder. To use this scan feature, the printer must be connected to a network; however, the feature is not available until it has been configured. There are two methods for configuring Scan to Network Folder, the **Save to Network Folder Setup Wizard** for basic setup and **Save to Network Folder Setup** for advanced setup.

Before you begin



 **NOTE:** To set up the Scan to Network Folder feature, the printer must have an active network connection.

Administrators need the following items before beginning the configuration process.

- Administrative access to the printer
- The fully-qualified domain name (FQDN) (e.g., \\servername.us.companyname.net\scans) of the destination folder OR the IP address of the server (e.g., \\16.88.20.20\scans).

 **NOTE:** The use of the term "server" in this context refers to the computer where the shared folder resides.

Step one: Access the HP Embedded Web Server

1. From the Home screen on the printer control panel, touch the Information  icon, and then touch the Network  icon to display the IP address or host name.
2. Open a web browser, and in the address line, type the IP address or host name exactly as it displays on the printer control panel. Press the **Enter** key on the computer keyboard. The EWS opens.

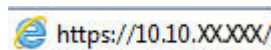

 **NOTE:** If the web browser displays a message indicating that accessing the website might not be safe, select the option to continue to the website. Accessing this website will not harm the computer.

The screenshot shows the HP Embedded Web Server (EWS) interface. At the top, there is a search bar and a 'Welcome Sign In' button. Below the search bar is a navigation menu with tabs: Information, General, Copy/Print, Scan/Digital Send, Fax, Troubleshooting, Security, HP Web Services, and Networking. The 'Information' tab is selected, and the 'Device Status' page is displayed. The page shows the printer's status, including sleep mode, supplies levels, and a table of media trays.

Device Status

Sleep mode on

Supplies

Black Cartridge Order 508A (CF360A) 90%*	Cyan Cartridge Order 508A (CF361A) 90%*	Magenta Cartridge Order 508A (CF363A) 90%*	Yellow Cartridge Order 508A (CF362A) 90%*
Fuser Kit Order 110V-B5L35A, 220V-B5L36A 100%*	Document Feeder Kit Order B5L52A 100%*	Toner Collection Unit B5L37A: OK	

* Estimated levels. Actual levels may vary.

[Supplies Details](#)

Media



Input/Output	Status	Capacity	Size	Type
Tray 1	Empty	100 sheets	Any Size	Any Type
Tray 2	OK	550 sheets	Letter (8.5x11)	Plain
Standard bin	OK	250 sheets	N/A	N/A

[Change Settings](#)

Step two: Set up Scan to Network Folder

Method one: Use the Scan to Network Folder Wizard

This option opens the setup wizard that is in the HP Embedded Web Server (EWS) for the printer. The setup wizard includes the options for basic configuration.

NOTE: Before you begin: To display the printer's IP address or host name, touch the Information , and then touch the Network  icon on the printer's control panel.

1. Using the EWS top navigation tabs, click **Scan/Digital Send** tab. The **Email and Scan to Network Folder Quick Setup Wizards** dialog opens.
2. In the left-navigation pane, click **Email and Scan to Network Folder Quick Setup Wizards**.
3. Click the **Save to Network Folder Quick Set Wizard** link.
4. On the **Add or Remove a Save to Network Folder Quick Set** dialog, click **Add**.

NOTE: Quick Sets are short-cut jobs that can be accessed on the printer Home screen or within the Quick Sets application.

NOTE: The Save to Network Folder feature can be minimally configured without creating a quick set. However, without the quick set, users must enter the destination folder information at the control panel for each scan job. A quick set is required to include Save to Network Folder metadata.

5. On the **Add Folder Quick Set** dialog, complete the following information:
 - a. In the **Quick Set Title** field, type a title.

Step two: Configure the Scan to Network Folder settings

1. On the **Scan to Network Folder Setup** page, select the **Enable Scan to Network Folder** check box. If this box is not selected, the feature is unavailable at the printer control panel.
2. In the Scan to Network Folder area of the left navigation pane, click **Quick Sets**. Click **Add** to open the **Quick Sets Setup** dialog.

 **NOTE:** Quick Sets are short-cut jobs that can be accessed on the printer Home screen or within the Quick Sets application.

 **NOTE:** The **Scan to Network Folder** feature can be minimally configured without creating a quick set. However, without the quick set, users must enter the destination folder information at the control panel for each scan job. A quick set is required to include Scan to Network Folder metadata.

Complete all of the settings in the Quick Set Setup to fully configure the Scan to Network Folder feature.

Dialog one: Set the Quick Set name, description, and options for user interaction at the control panel

Use the **Set the button location for the Quick Set and options for user interaction at the control panel** dialog to configure where the **Quick Set** button will display on the printer control panel and to configure the level of user interaction at the printer control panel.

1. In the **Quick Set Name** field, type a title.

 **NOTE:** Name the Quick Set something that users can understand quickly (e.g., "Scan and save to a folder").

2. In the **Quick Set Description** field, type a description explaining what the Quick Set will save.
3. From the **Quick Set Start Option** list, select one of the following options:

- Option one: **Enter application, then user presses Start**
- Option two: **Start instantly upon selection**

Select one of the following prompt options :

- **Prompt for original sides**
- **Prompt for additional pages**
- **Require Preview**

 **NOTE:** If **Start instantly upon selection** is selected, the destination folder must be entered in the next step.

4. Click **Next**.

Dialog two: Folder Settings

Use the **Folder Settings** dialog to configure the types of folders the printer sends scanned documents to.

There are two types of destination folders to select from:

- Shared folders or FTP folders
- Personal shared folders

There are two types of folder permissions to select from:

- Read and write access
- Write access only

The following information describes how to configure the folder settings.

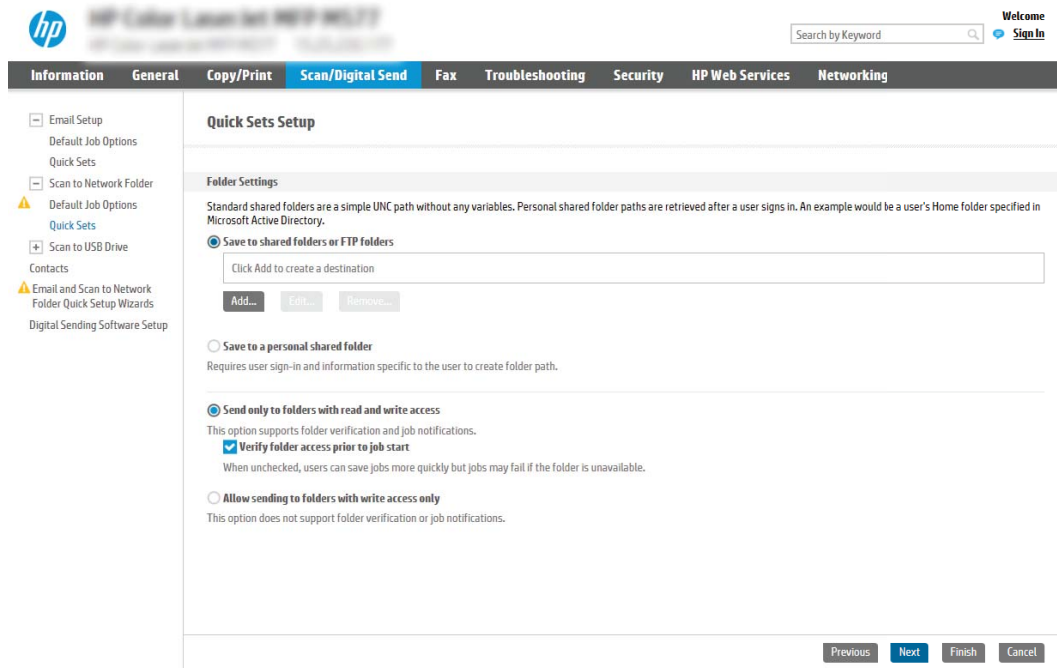

Configure the destination folder for scanned documents

Option 1: Shared folders or FTP folders

To save scanned documents to a standard shared folder or an FTP folder, complete the following steps:

1. If it is not already selected, select **Save to shared folders or FTP folders**.
2. Click **Add...**. The **Add Network Folder Path** dialog opens.
3. On the **Add Network Folder Path** dialog, select one of the following options:
 - Option one: **Save to a standard shared network folder**



- Email Setup
 - Default Job Options
 - Quick Sets
- Scan to Network Folder
 - Default Job Options
 - Quick Sets
- Scan to USB Drive
- Contacts
- Email and Scan to Network Folder Quick Setup Wizards
- Digital Sending Software Setup

Quick Sets Setup

Add Network Folder Path

 Save to a standard shared network folder

UNC Folder Path:

(\path\path)

Custom Subfolder:

Appends a custom subfolder at end of the folder path.

 Restrict subfolder access to user

Folder Path Preview:

Update Preview

Some Custom Subfolder values will be updated only when the Quick Set is used.

Authentication Settings:

Use credentials of user to connect after Sign In at the control panel

Windows Domain:

 Save to an FTP Server

A Workstation or Server that has a File Transfer Protocol (FTP) service installed and configured.

OK Cancel



NOTE: For more information about creating shared network folders see [Set up a shared folder](#) (c04431534).

1. If it is not already selected, select **Save to a standard shared network folder**.
2. In the **UNC Folder Path** field, type a folder path.

The folder path can either be the fully-qualified domain name (FQDN) (e.g., \servername.us.companyname.net\scans) or the IP address of the server (e.g., \16.88.20.20\scans). Be sure that the folder path (e.g., \scans) follows the FQDN or IP address.



NOTE: The FQDN can be more reliable than the IP address. If the server gets its IP address via DHCP, the IP address can change. However, the connection with an IP address might be faster because the printer does not need to use DNS to find the destination server.

3. To automatically create a subfolder for scanned documents in the destination folder, select a format for the subfolder name from the **Custom Subfolder** list.
To restrict the subfolder access to the user who creates the scan job, select **Restrict subfolder access to user**.
4. To view the complete folder path for scanned documents, click **Update Preview**.
5. From the **Authentication Settings** list, select one of the following options:
 - Use credentials of user to connect after Sign In at the control panel
 - Always use these credentials



NOTE: If **Always use these credentials** is selected, a user name and password must be entered in the corresponding fields.

6. In the **Windows Domain** field, type the Windows domain.

 **NOTE:** To find the Windows domain in Windows 7, click **Start**, click **Control Panel**, click **System**.

To find the Windows domain in Windows 8, click **Search**, enter **System** in the search box, and then click **System**.

The domain is listed under **Computer name, domain, and workgroup settings**.

 **NOTE:** If a shared folder is set to be accessed by everyone, values for a workgroup name (default is “Workgroup”), a user name and password must be entered in the corresponding fields. However, if the folder is within a particular user’s folders and not Public, the user name and password of that user must be used.

 **NOTE:** An IP address might be necessary instead of a computer name. Many home routers do not handle computer names well, and there is no Domain Name Server (DNS). In this case, it is best to set up a static IP address on the shared PC to alleviate the problem of DHCP assigning a new IP address. On a typical home router, this is done by setting a static IP address that is on the same subnet, but outside the DHCP address range.

7. Click **OK**.

- Option two: **Save to an FTP Server**

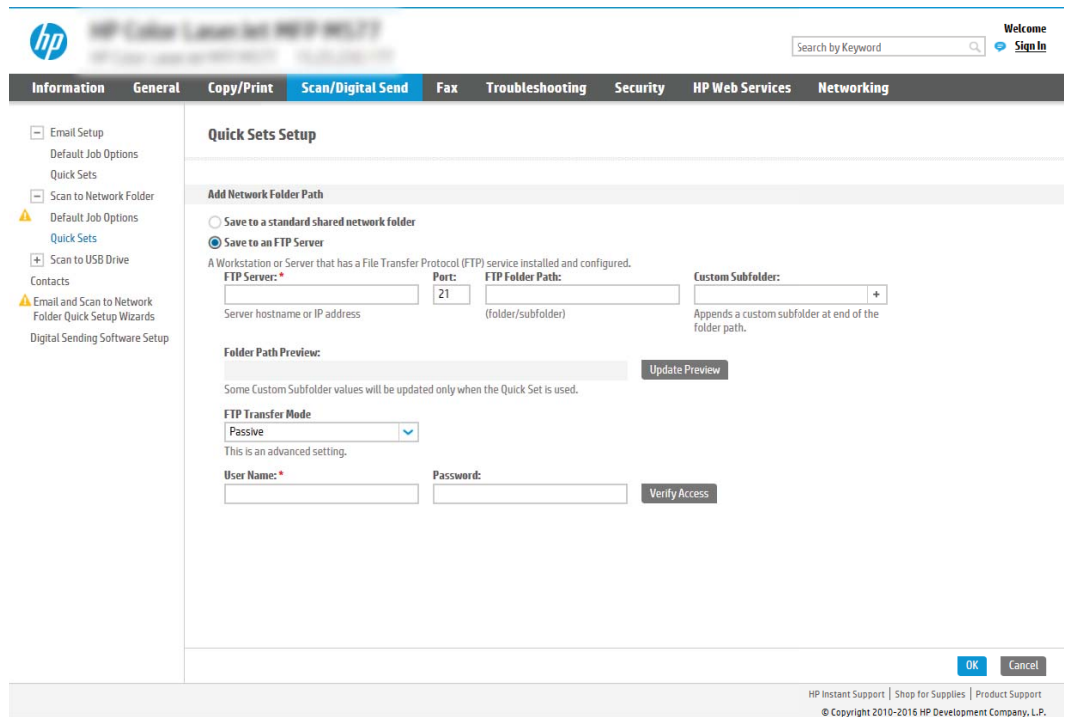

The screenshot shows the HP EWS 'Quick Sets Setup' interface. The 'Scan/Digital Send' tab is active. Under 'Add Network Folder Path', the 'Save to an FTP Server' option is selected. The form includes fields for 'FTP Server' (Server hostname or IP address), 'Port' (set to 21), 'FTP Folder Path' (folder/subfolder), and 'Custom Subfolder'. There is a 'Folder Path Preview' section with an 'Update Preview' button. The 'FTP Transfer Mode' is set to 'Passive'. There are also 'User Name' and 'Password' fields with a 'Verify Access' button. The interface includes a navigation menu on the left, a search bar at the top right, and footer information at the bottom right.

 **NOTE:** If an FTP site is outside the firewall, a proxy server must be specified under the network settings. These settings are located in the **EWS Networking** tab, under the **Advanced** options.

1. Select **Save to an FTP Server**.
2. In the **FTP Server** field, type the FTP server name or IP address.
3. In the **Port** field, type the port number.

 **NOTE:** In most cases, the default port number does not need to be changed.

4. To automatically create a subfolder for scanned documents in the destination folder, select a format for the subfolder name from the **Custom Subfolder** list.
5. To view the complete folder path for scanned documents, click **Update Preview**.
6. From the **FTP Transfer Mode** list, select one of the following options:
 - **Passive**
 - **Active**
7. In the **Username** field, type the user name.
8. In the **Password field**, type the password.
9. Click **Verify Access** to confirm the destination can be accessed.
10. Click **OK**.

Option 2: Personal shared folders

To save scanned documents to a personal shared folder, complete the following steps:

 **NOTE:** This option is used in domain environments where the administrator configures a shared folder for each user. If the Save to a personal shared folder feature is configured, users will be required to sign in at the printer control panel using Windows credentials or LDAP authentication.

1. Select **Save to a personal shared folder**.
2. In the **Retrieve the device user's home folder using this attribute** field, type the user's home folder in the Microsoft Active Directory.

 **NOTE:** Verify that the user knows where this home folder is located on the network.

3. To add a user name subfolder at the end of the folder path, select **Create subfolder based on user name**.
To restrict the subfolder access to the user who creates the scan job, select **Restrict subfolder access to user**.

Select the destination folder permissions

Option 1: Read and write access

To send scanned documents to a folders configured for read and write access, complete the following steps:

 **NOTE:** **Send only to folders with read and write access** supports folder verification and job notification

1. If it is not already selected, select **Send only to folders with read and write access**.
2. To require the printer to verify folder access before starting a scan job, select **Verify folder access prior to job start**.

 **NOTE:** Scan jobs can complete more quickly if **Verify folder access prior to job start** is not selected; however, if the folder is unavailable, the scan job will fail.

3. Click **Next**.

Option 2: Write access only

To send scanned documents to a folder configured for write access only, complete the following steps:

 **NOTE:** **Allow sending to folders with write access only** does not support folder verification or job notification

 **NOTE:** If this option is selected, the printer cannot increment the scan filename. It sends the same filename for all scans.

Select a time-related filename prefix or suffix for the scan filename, so that each scan is saved as a unique file, and does not overwrite a previous file. This filename is determined by the information in the File Settings dialog in the Quick Set Wizard.

1. Select **Allow sending to folders with write access only**.
2. Click **Next**.

Dialog three: Notification settings

▲ On the **Notification Settings** dialog, complete one of the following tasks:

 **NOTE:** In order to send notification emails, the printer must be set up to use an SMTP server for sending email jobs. For more information about setting up the SMTP server for sending emails see [Set up Scan to Email](#) (c04017973).

- Option one: **Do not notify**
 1. Select **Do not notify**.
 2. To prompt the user to review their notification settings, select **Prompt user prior to job start**, and then click **Next**.
- Option two: **Notify when job completes**
 1. Select **Notify when job completes**.
 2. Select the method for delivering the notification from the **Method Used to Deliver Notification** list.

If the method of notification selected is **Email**, type the email address in the **Notification Email Address** field.
 3. To include a thumbnail of the first scanned page in the notification, select **Include Thumbnail**.
 4. To prompt the user to review their notification settings, select **Prompt user prior to job start**, and then click **Next**.
- Option three: **Notify only if job fails**
 1. Select **Notify only if job fails**.
 2. Select the method for delivering the notification from the **Method Used to Deliver Notification** list.

If the method of notification selected is **Email**, type the email address in the **Notification Email Address** field.
 3. To include a thumbnail of the first scanned page in the notification, select **Include Thumbnail**.
 4. To prompt the user to review their notification settings, select **Prompt user prior to job start**, and then click **Next**.

Dialog four: Scan Settings

On the **Scan Settings** dialog, set the default scanning preferences for the Quick Set, and then click **Next**.

Scan settings:

Feature	Description
Original Size	Select the page size of the original document.
Original Sides	Select whether the original document is single-sided or double-sided.
Optimize Text/Picture	Select to optimize for the output of a particular type of content.
Content Orientation	Select the way the content of the original document is placed on the page: Portrait or Landscape .
Background Cleanup	Select a value to remove faint images from the background or to remove a light background color.
Darkness	Select a value to adjust the darkness of the file.
Contrast	Select a value to adjust the contrast of the file.
Sharpness	Select a value to adjust the sharpness of the file.
Image Preview	Select whether to require or make optional a displayed preview of the job or to disable a preview.
Cropping Options	Select whether or not to allow a job to be cropped and the type of cropping option.
Erase Edges	Select this setting to specify the width of edge margins to be erased, in either inches or millimeters, for the front side and back side of a job.

Dialog five: File Settings

On the **File Settings** dialog, set the default file settings for the Quick Set, and then click **Next**.

File settings:

Feature	Description
File Name Prefix	Set the default file name prefix used for files saved to a network folder.
File Name	Default file name for the file to be saved. Select the User editable check box to make this setting editable at the printer control panel.
File Name Suffix	Set the default file name suffix used for files saved to a network folder.
File Name Preview	Enter a file name, and then click the Update Preview button.
File Numbering Format	Select a file name format for when the job is divided into multiple files.
Add numbering when job has just one file (ex. _1-1)	Select this setting to add numbering to a file name when the job is only one file instead of multiple files.
File Type	Select the file format for the saved file. Select the User editable check box to make this setting editable at the printer control panel.
High Compression (smaller file)	Select this setting to compress the scanned file, which reduces the file size. However, the scanning process for a High compression file might take longer than for a Normal compression file.
PDF encryption	If the file type is PDF, then this option encrypts the output PDF file. A password must be specified as part of the encryption. The same password must be used to open the file. The user will be prompted to enter a password prior to scanning their job if one has not been set prior to pressing start.

Feature	Description
Resolution	Set the resolution for the file. Higher resolution images have more dots per inch (dpi), so they show more detail. Lower resolution images have fewer dots per inch and show less detail, but the file size is smaller.
Quality and File Size	Select the quality for the file. Higher-quality images require a larger file size than lower-quality images, and they take more time to send.
Color/Black	Specify whether copies are to be printed in color, black and gray, or black only.
Suppress blank pages	If the Suppress blank pages option is enabled, blank pages will be ignored.
Meta Data File Format	Use the drop-down list to select the file format for meta-data information.
Create Multiple Files	Select this setting to scan pages into separate files based on a predetermined maximum number of pages per file.

Dialog six: Summary

On the **Summary** dialog, review the **Summary** dialog, and then click **Finish**.

Step three: Complete the configuration

1. In the left-navigation pane, click **Scan to Network Folder**.
2. On the **Scan to Network Folder** page, review the selected settings, and then click **Apply** to complete the setup.



Set up Scan to USB Drive

- [Introduction](#)
- [Step one: Access the HP Embedded Web Server](#)
- [Step two: Enable Scan to USB Drive](#)
- [Step three: Configure the Quick Sets \(optional\)](#)
- [Default scan settings for Scan to USB Drive setup](#)
- [Default file settings for Save to USB Setup](#)

Introduction

The printer has a feature that enables it to scan a document and save it to a USB flash drive. The feature is not available until it has been configured through the HP Embedded Web Server (EWS).

Step one: Access the HP Embedded Web Server

1. From the Home screen on the printer control panel, touch the Information  icon, and then touch the Network  icon to display the IP address or host name.
2. Open a web browser, and in the address line, type the IP address or host name exactly as it displays on the printer control panel. Press the **Enter** key on the computer keyboard. The EWS opens.

 <https://10.10.XXXXX/>

 **NOTE:** If the web browser displays a message indicating that accessing the website might not be safe, select the option to continue to the website. Accessing this website will not harm the computer.

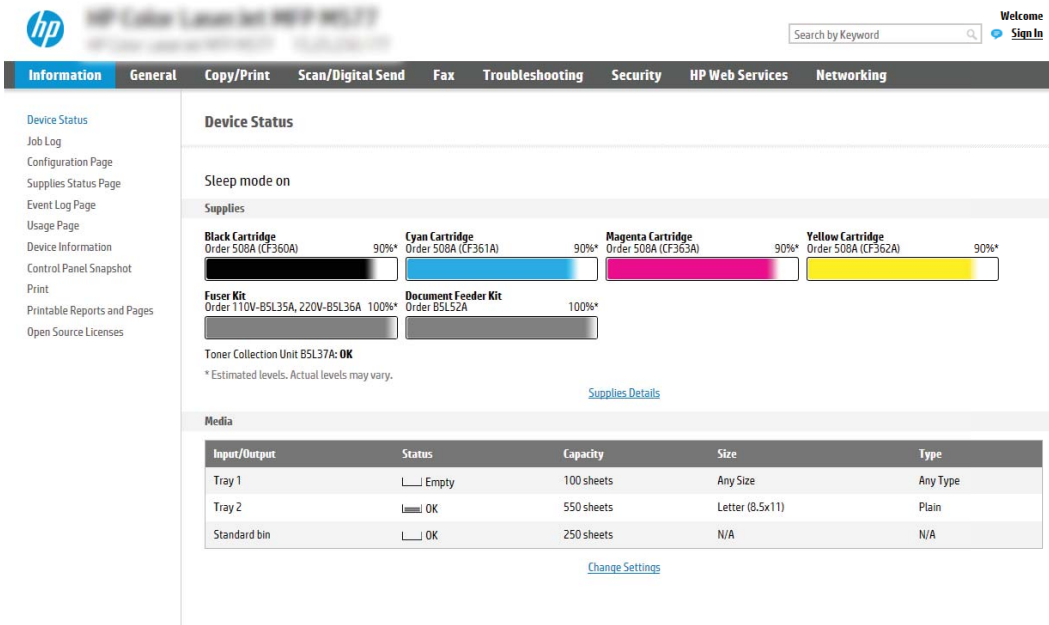

The screenshot shows the HP Embedded Web Server (EWS) interface. The top navigation bar includes tabs for Information, General, Copy/Print, Scan/Digital Send, Fax, Troubleshooting, Security, HP Web Services, and Networking. The left sidebar lists various status and configuration pages. The main content area displays the 'Device Status' page, which includes a 'Supplies' section with progress bars for Black, Cyan, Magenta, and Yellow cartridges, as well as Fuser Kit and Document Feeder Kit. Below this is a 'Media' section with a table showing the status, capacity, size, and type of paper in the trays.

Input/Output	Status	Capacity	Size	Type
Tray 1	Empty	100 sheets	Any Size	Any Type
Tray 2	OK	550 sheets	Letter (8.5x11)	Plain
Standard bin	OK	250 sheets	N/A	N/A

Step two: Enable Scan to USB Drive

1. Select the **Security** tab.
2. Scroll to **Hardware Ports** and make sure that **Enable Host USB plug and play** is enabled.
3. Select the **Copy/Print** tab for MFP models or the **Print** tab for SFP models.
4. Select the **Enable Save to USB** check box.
5. Click **Apply** at the bottom of the page.



NOTE: Most devices ship with Hard disk drives (HDDs) already installed. In some cases, additional storage devices can be added via USB. Verify whether the Save to USB feature needs to be expanded to USB and Hard drive

Step three: Configure the Quick Sets (optional)



NOTE: Quick Sets are short-cut jobs that can be accessed on the printer Home screen or within the Quick Sets application.

1. In the **Scan to USB Drive** area of the left navigation pane, click **Quick Sets**.
2. Select one of the following options:
 - Select an existing Quick Set under Quick Sets Application in the table.
 - OR-
 - Click **Add** to start the Quick Set Wizard.
3. If you selected **Add**, the **Quick Sets Setup** page opens. Complete the following information:
 - **Quick Set Name:** Enter a title for the new Quick Set.
 - **Quick Set Description:** Enter a description of the Quick Set.
 - **Quick Set Start Option:** To set how the Quick Set starts, click either **Enter application, then user presses Start** or **Start instantly when selected from the Home Screen**.
4. Select a default location where scanned files are saved on USB storage devices inserted into the USB port on the control panel, and then click **Next**. The default location options are:
 - **Save at root directory of the USB storage device**
 - **Create or place in this folder on the USB Storage Device** — The path to the folder on the USB storage device must be specified when using this file location option. A backslash \ must be used to separate folder\subfolder names in the path.
5. Select an option from the **Condition on Which to Notify:** drop-down list, and then click **Next**.

This setting determines if, or how, users are notified when a Save To USB Quick Set job completes or fails. The options for the **Condition on Which to Notify:** setting are:

 - **Do not notify**
 - **Notify when job completes**
 - **Notify only if job fails**

6. Choose the **Scan Settings** for the Quick Set, and then click **Next**.

 **NOTE:** For more information on the available scan settings, see [Default scan settings for Scan to USB Drive setup on page 108](#)

7. Choose the **File Settings** for the Quick Set, and then click **Next**.

 **NOTE:** For more information on the available file settings, see [Default scan settings for Scan to USB Drive setup on page 108](#)

8. Review the summary of settings, and then click **Finish** to save the Quick Set, or click **Previous** to edit the settings.

Default scan settings for Scan to USB Drive setup

Table 6-1 Scan settings for Scan to USB Drive Setup:

Feature	Description
Original Size	Select the page size of the original document.
Original Sides	Select whether the original document is single-sided or double-sided.
Optimize Text/Picture	Select to optimize for the output of a particular type of content.
Content Orientation	Select the way the content of the original document is placed on the page: Portrait or Landscape .
Background Cleanup	Select a value to remove faint images from the background or to remove a light background color.
Darkness	Select a value to adjust the darkness of the file.
Contrast	Select a value to adjust the contrast of the file.
Sharpness	Select a value to adjust the sharpness of the file.
Image Preview	Select whether to require or make optional a displayed preview of the job or to disable a preview.
Cropping Options	Select whether or not to allow a job to be cropped and the type of cropping option.
Erase Edges	Select this setting to specify the width of edge margins to be erased, in either inches or millimeters, for the front side and back side of a job.

Default file settings for Save to USB Setup

Table 6-2 File settings for Save to USB Setup:

Option name	Description
File Name Prefix	Set the default file name prefix used for files saved to a network folder.
File Name	Default file name for the file to be saved. Select the User editable check box to make this setting editable at the printer control panel.
File Name Suffix	Set the default file name suffix used for files saved to a network folder. Duplicate filename suffix default [filename]_YYYYMMDDT

Table 6-2 File settings for Save to USB Setup: (continued)

Option name	Description
File Name Preview	Enter a file name, and then click the Update Preview button.
File Numbering Format	Select a file name format for when the job is divided into multiple files.
Add numbering when job has just one file (ex. _1-1)	Select this setting to add numbering to a file name when the job is only one file instead of multiple files.
File Type	Select the file format for the saved file. Select the User editable check box to make this setting editable at the printer control panel.
High Compression (smaller file)	Select this setting to compress the scanned file, which reduces the file size. However, the scanning process for a High compression file might take longer than for a Normal compression file.
PDF encryption	If the file type is PDF, then this option encrypts the output PDF file. A password must be specified as part of the encryption. The same password must be used to open the file. The user will be prompted to enter a password prior to scanning their job if one has not been set prior to pressing start.
Resolution	Set the resolution for the file. Higher resolution images have more dots per inch (dpi), so they show more detail. Lower resolution images have fewer dots per inch and show less detail, but the file size is smaller.
Quality and File Size	Select the quality for the file. Higher-quality images require a larger file size than lower-quality images, and they take more time to send.
Color/Black	Specify whether copies are to be printed in color, black and gray, or black only.
Suppress blank pages	If the Suppress blank pages option is enabled, blank pages will be ignored.
Create Multiple Files	Select this setting to scan pages into separate files based on a predetermined maximum number of pages per file.

Set up Save to SharePoint® (Flow models only)

- [Introduction](#)
- [Before you begin](#)
- [Step one: Access the HP Embedded Web Server \(EWS\)](#)
- [Step two: Enable Save to SharePoint® and create a Save to SharePoint Quick Set](#)
- [Scan and save a file directly to a Microsoft® SharePoint site](#)
- [Quick set scan settings and options for Save to SharePoint®](#)

Introduction

Use Save the SharePoint® to scan documents directly to a Microsoft® SharePoint site. This feature eliminates the need to scan the documents to a network folder, USB flash drive, or email message, and then manually upload the files to the SharePoint site.

Save to SharePoint® supports all scanning options, including the ability to scan documents as images or use the OCR features to create text files or searchable PDFs.

The feature is disabled by default. Enable Save to SharePoint® in the HP Embedded Web Server (EWS).





NOTE: The Save to Sharepoint® feature is only available on workflow-equipped printers.

Before you begin

Before this procedure can be completed, the destination folder that the scanned files will be saved to must exist on the SharePoint site, and write access must be enabled to the destination folder. Save to SharePoint® is disabled by default.

Step one: Access the HP Embedded Web Server (EWS)

1. From the Home screen on the printer control panel, touch the Information  icon, and then touch the Network  icon to display the IP address or host name.
2. Open a web browser, and in the address line, type the IP address or host name exactly as it displays on the printer control panel. Press the **Enter** key on the computer keyboard. The EWS opens.

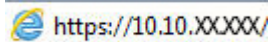
A screenshot of a web browser address bar showing the URL "https://10.10.XXXX/". The address bar has a blue border and a small icon on the left.

NOTE: If the web browser displays a message indicating that accessing the website might not be safe, select the option to continue to the website. Accessing this website will not harm the computer.

The screenshot displays the HP printer's control panel interface. At the top, there is a navigation bar with tabs for Information, General, Copy/Print, Scan/Digital Send, Fax, Troubleshooting, Security, HP Web Services, and Networking. Below this, the 'Device Status' page is active. It shows 'Sleep mode on' and a 'Supplies' section with four color-coded progress bars: Black Cartridge (90%), Cyan Cartridge (90%), Magenta Cartridge (90%), and Yellow Cartridge (90%). Below these are 'Fuser Kit' and 'Document Feeder Kit', both at 100%. A 'Media' section contains a table with columns for Input/Output, Status, Capacity, Size, and Type. The table lists Tray 1 (Empty, 100 sheets), Tray 2 (OK, 550 sheets), and Standard bin (OK, 250 sheets). A 'Change Settings' link is visible at the bottom of the media section.

Step two: Enable Save to SharePoint® and create a Save to SharePoint Quick Set

Follow these steps to enable the feature **Save to SharePoint** feature and create a Save to SharePoint Quick Set:

1. Using the top navigation tabs, click **Scan/Digital Send**.
2. In the left navigation pane, click **Save to SharePoint®**.

 **NOTE:** Quick Sets are short-cut jobs that can be accessed on the printer Home screen or within the **Quick Sets** application.

3. Select **Enable Save to SharePoint®**, and then click **Apply**.
4. In the **Save to SharePoint®** area of the left navigation pane, click **Quick Sets**. Click **Add** to launch the Quick Set Wizard.
5. Enter a **Quick Set Name** (for example, "Scan to Sharepoint") and a **Quick Set Description**.
6. Select a **Quick Set Start Option** to determine what occurs after selecting a Quick Set on the printer control panel, and then click the **Next** button.
7. Use the following steps to add the path to the SharePoint folder.
 - a. Click **Add** on the **SharePoint® Destination Settings** page to open the **Add SharePoint® Path** page.
 - b. Open another browser window, navigate to the SharePoint folder to use, and then copy the folder path for the SharePoint folder from that browser window.
 - c. Paste the SharePoint folder path into the **SharePoint® Path:** field.
 - d. By default, the printer overwrites an existing file that has the same file name as the new file. Clear **Overwrite existing files** so that a new file with the same name as an existing file is given an updated time/date stamp.
 - e. Select an option from the **Authentication Settings** drop-down menu. Select whether it is necessary to sign in to the SharePoint site with credentials, or store the credentials within the Quick Set.

 **NOTE:** Use credentials of user to connect after Sign In at the control panel is selected in the **Authentication Settings** drop-down menu, the logged-in user must have permissions to write to the specified SharePoint site.

 **NOTE:** For security purposes, the printer does not display credentials entered in the Quick Set Wizard.

- f. Click **OK** to complete the SharePoint path setup and navigate back to the **SharePoint Destination Settings** page.
8. Select **Verify folder access prior to job start** to ensure that the SharePoint folder specified as the destination folder is accessible each time the Quick Set is used. If this option is not selected, jobs can be saved to the SharePoint folder more quickly. However, if this option is not selected *and* the SharePoint folder is inaccessible the job will fail.
9. Click **Next**.
10. Set a **Condition on Which to Notify**: on the **Notification Settings** page. This setting configures the Quick Set to either not notify, or to send email messages or print a summary page if a job either completes successfully or fails. Select one of the following options from the **Condition on Which to Notify**: drop-down menu:
 - Select **Do not notify** for the Quick Set to not perform any notification action when a job completes successfully or fails.
 - Select **Notify when job completes** to for the Quick Set to send a notification when a job completes successfully.
 - Select **Notify only if job fails** to for the Quick Set to send a notification only when a job fails.

Selecting either **Notify when job completes** or **Notify only if job fails** requires the **Method Used to Deliver Notification**: to be set. Select from the following options:

- **Email**: Use this option to send an email when the selected notification condition occurs. This option requires a valid email address in the **Notification Email Address**: field.

 **NOTE:** To use the email notification feature, first configure the email feature on the printer.

- **Print**: Use this option to print the notification when the selected notification condition occurs.

 **NOTE:** Select **Include Thumbnail** for either notification option to include a thumbnail image of the first page of the scanned page of the job.

11. Click **Next**.
12. Select options from the **Scan Settings** page, and then click **Next**. For more information, see [Table 6-3 Scan settings for Save to SharePoint® on page 114](#).
13. Select options from the **File Settings** page, and then click **Next**. For more information, see [Table 6-4 File settings for Save to SharePoint on page 114](#).
14. Review the summary of settings, and then click the **Finish** button to save the Quick Set, or click the **Previous** button to edit the settings.

Scan and save a file directly to a Microsoft® SharePoint site

1. Place the document face-down on the scanner glass, or place it face-up in the document feeder and adjust the paper guides to fit the size of the document.
2. From the Home screen on the printer control panel, select [Scan](#), and then select [Scan to SharePoint®](#).



NOTE: It might be necessary to sign in to the printer to use this feature.

3. To select a Quick Set, in the [Quick Sets and Defaults](#) area touch [Load](#). Select a Quick Set, and then touch [Load](#).
4. Touch the [File Name:](#) text field to open a keyboard, and then type the name for the file using either the on-screen keyboard or the physical keyboard. Touch Enter [↵](#).
5. Touch [Options](#) to view and configure settings for the document.
6. Touch the right pane of the screen to preview the document. In the preview screen, use the buttons on the right of the screen to adjust the preview options and to rearrange, rotate, insert, or remove pages.



Use these buttons to toggle between single-page view and thumbnail view. More options are available in thumbnail view than in single-page view.



Use these buttons to zoom in or out on the selected page.

NOTE: Select only one page at a time to use these buttons.



Use this button to rotate the page 180 degrees.

NOTE: This button is available only in the thumbnail view.



Use this button to delete the selected pages.

NOTE: This button is available only in the thumbnail view.



Use these buttons to rearrange the pages within the document. Select one or more pages and move them to the left or right.

NOTE: These buttons are available only in the thumbnail view.





Use this button to add a page to the document. The printer prompts to scan additional pages.



Use this button to clear the changes made in the preview and start over.



Touch this button to collapse the preview screen and return to the Copy screen.

7. Touch the Start  button to save the file.

Quick set scan settings and options for Save to SharePoint®

The following tables list the settings and options available in the Quick Set Wizard when adding, editing, or copying a Save to SharePoint® Quick Set.

Table 6-3 Scan settings for Save to SharePoint®

Feature	Description
Original Size	Select the page size of the original document.
Original Sides	Select whether the original document is single-sided or double-sided.
Optimize Text/Picture	Select to optimize for the output of a particular type of content.
Content Orientation	Select the way the content of the original document is placed on the page: Portrait or Landscape .
Background Cleanup	Select a value to remove faint images from the background or to remove a light background color.
Darkness	Select a value to adjust the darkness of the file.
Contrast	Select a value to adjust the contrast of the file.
Sharpness	Select a value to adjust the sharpness of the file.
Image Preview	Select whether to require or make optional a displayed preview of the job or to disable a preview.
Cropping Options	Select whether or not to allow a job to be cropped and the type of cropping option.
Erase Edges	Select this setting to specify the width of edge margins to be erased, in either inches or millimeters, for the front side and back side of a job.

Table 6-4 File settings for Save to SharePoint

Feature	Description
File Name Prefix	Set the default file name prefix used for files saved to a network folder.
File Name	Default file name for the file to be saved. Select the User editable check box to make this setting editable at the printer control panel.
File Name Suffix	Set the default file name suffix used for files saved to a network folder. Duplicate filename suffix default [filename]_YYYYMMDDT

Table 6-4 File settings for Save to SharePoint (continued)

Feature	Description
File Name Preview	Enter a file name, and then click the Update Preview button.
File Numbering Format	Select a file name format for when the job is divided into multiple files.
Add numbering when job has just one file (ex. _1-1)	Select this setting to add numbering to a file name when the job is only one file instead of multiple files.
File Type	Select the file format for the saved file. Select the User editable check box to make this setting editable at the printer control panel.
High Compression (smaller file)	Select this setting to compress the scanned file, which reduces the file size. However, the scanning process for a High compression file might take longer than for a Normal compression file.
PDF encryption	If the file type is PDF, then this option encrypts the output PDF file. A password must be specified as part of the encryption. The same password must be used to open the file. The user will be prompted to enter a password prior to scanning their job if one has not been set prior to pressing start.
Resolution	Set the resolution for the file. Higher resolution images have more dots per inch (dpi), so they show more detail. Lower resolution images have fewer dots per inch and show less detail, but the file size is smaller.
Quality and File Size	Select the quality for the file. Higher-quality images require a larger file size than lower-quality images, and they take more time to send.
Color/Black	Specify whether copies are to be printed in color, black and gray, or black only
Suppress blank pages	If the Suppress blank pages option is enabled, blank pages will be ignored.
Create Multiple Files	Select this setting to scan pages into separate files based on a predetermined maximum number of pages per file.

Create a Quick Set

- [Introduction](#)
- [Step one: Access the HP Embedded Web Server \(EWS\)](#)
- [Step two: Add and manage Quick Sets](#)

Introduction



Quick Sets are short-cut jobs that are available from the Home screen or within the [Quick Sets](#) feature on the printer control panel and do not impact the defaults set for the base application. To use a Quick Set on the printer control panel, enable the base application.

Create Quick Sets for the following base applications to improve job accuracy and decrease the time to complete a job:

- **Email** — Use email Quick Sets to configure and save commonly used settings for sending jobs from the printer via email as email attachments.
- **Fax** — Use fax Quick Sets to configure and save commonly used settings for fax jobs.
- **Save to Network Folder** — Use Save to Network Folder Quick Sets to configure and save commonly used settings for saving jobs to a network folder.
- **Save to USB** — Use Save to USB Quick Sets to configure and save commonly used settings for saving jobs to a USB device.
- **Copy** (MFPs only) — Use Copy Quick Sets to configure and save commonly used settings for copy jobs.
- **Save to SharePoint®** (Flow models only) — se Save to SharePoint Quick Sets to configure and save commonly used settings for saving jobs to a SharePoint site.

Select from various job options, such as starting a job immediately upon selection of a quick set or requiring an image preview before starting a job.

Step one: Access the HP Embedded Web Server (EWS)

1. From the Home screen on the printer control panel, touch the Information  icon, and then touch the Network  icon to display the IP address or host name.
2. Open a web browser, and in the address line, type the IP address or host name exactly as it displays on the printer control panel. Press the [Enter](#) key on the computer keyboard. The EWS opens.

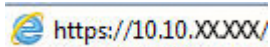

 **NOTE:** If the web browser displays a message indicating that accessing the website might not be safe, select the option to continue to the website. Accessing this website will not harm the computer.

The screenshot shows the HP EWS interface for a printer. The top navigation bar includes tabs for Information, General, Copy/Print, Scan/Digital Send, Fax, Troubleshooting, Security, HP Web Services, and Networking. The left sidebar lists various status and configuration pages. The main content area is titled 'Device Status' and includes sections for Sleep mode, Supplies, and Media. The Supplies section shows four color cartridges (Black, Cyan, Magenta, Yellow) and two kits (Fuser Kit, Document Feeder Kit) with their respective levels and order numbers. The Media section contains a table with columns for Input/Output, Status, Capacity, Size, and Type.

Input/Output	Status	Capacity	Size	Type
Tray 1	Empty	100 sheets	Any Size	Any Type
Tray 2	OK	550 sheets	Letter (8.5x11)	Plain
Standard bin	OK	250 sheets	N/A	N/A

Step two: Add and manage Quick Sets

Add a Quick Set

Use the following steps to add a new Quick Set.

1. Using the top navigation tabs, click **General**.
2. In the left navigation pane, click **Quick Sets**.
3. Click **Add**. The **Quick Sets Setup** page opens.

 **NOTE:** Click **Cancel** on any page of **Quick Sets Setup** to cancel the current changes, exit **Quick Sets Setup**, and return to the **Quick Sets** page.

4. Select a **Quick Set Type**, and then click **Next**. The following Quick Set types are available for selection, depending on your printer:

 **NOTE:** A **Quick Set Type** only needs to be determined when a quick set is created by using the **General** EWS tab.

- Scan to Email
- Scan to Fax
- Scan to Network Folder
- Scan to USB Drive
- Copy (MFPs only)
- Save to SharePoint® (workflow printers only)

5. Enter a title for the Quick Set in the **Quick Set Name** (required) field.
6. Enter a description of the Quick Set in the **Quick Set Description** field.

7. Select a **Quick Set Start Option** to determine what occurs after selecting a Quick Set on the printer control panel, and then click **Next**.
 8. Select settings and complete tasks in **Quick Sets Setup**. Click **Next** to proceed to the next page of available options until reaching the **Summary** page.
-
-  **NOTE:** The settings available in **Quick Sets Setup** vary by the type of Quick Set being added. Refer to the tables in [Quick Set settings and options on page 119](#) to see the available settings and options for each type of Quick Set.
-
9. Review the summary of settings, and then click **Finish** to save the Quick Set, or click **Previous** to edit the settings.

Edit a Quick Set

Use the following steps to edit the settings of an existing Quick Set.

1. Using the top navigation tabs, click **General**.
2. In the left navigation pane, click **Quick Sets**.
3. In the **Quick Sets List** area, click the check box next to the appropriate Quick Set, and then click **Edit**. The **Quick Sets Setup** page opens.

 **NOTE:** Click **Cancel** on any page of **Quick Sets Setup** to cancel the current changes, exit **Quick Sets Setup**, and return to the **Quick Sets** page.

4. If necessary, modify the following settings, and then click **Next**:
 - **Quick Set Name**
 - **Quick Set Description**
 - **Quick Set Start Option**
5. Select settings and complete tasks in **Quick Sets Setup**. Click **Next** to proceed to the next page of available options until reaching the **Summary** page.

 **NOTE:** The settings available in **Quick Sets Setup** vary by the type of Quick Set being edited. Refer to the tables in [Quick Set settings and options on page 119](#) to see the available settings and options for each type of Quick Set.

6. Review the **Summary** page, and then click **Finish** to save changes made to the Quick Set.

Copy a Quick Set

1. Using the top navigation tabs, click **General**.
2. In the left navigation pane, click **Quick Sets**.
3. In the **Quick Sets List** area, click the check box next to the appropriate Quick Set, and then click **Copy**. The **Quick Sets Setup** page opens.

 **NOTE:** Click **Cancel** on any page of **Quick Sets Setup** to cancel the current changes, exit **Quick Sets Setup**, and return to the **Quick Sets** page.

4. If necessary, modify the following settings, and then click **Next**:

- Quick Set Name
 - Quick Set Description
 - Quick Set Start Option
5. Select settings and complete tasks in **Quick Sets Setup**. Click **Next** to proceed to the next page of available options until reaching the **Summary** page.

 **NOTE:** The settings available in **Quick Sets Setup** vary by the type of Quick Set being copied. Refer to the tables in [Quick Set settings and options on page 119](#) to see the available settings and options for each type of Quick Set.

6. Review the **Summary** page, and then click **Finish** to save the Quick Set.

Remove a Quick Set

Use the following steps to remove a Quick Set.

1. Using the top navigation tabs, click **General**.
2. In the left navigation pane, click **Quick Sets**.
3. In the **Quick Sets List** area, click the check box next to the appropriate Quick Set, and then click **Remove...**
4. When the **Confirmation Page** opens, click **Remove** to finish removing the Quick Set.

Quick Set settings and options

The following tables list the settings and options available in the Quick Set Wizard when adding, editing, or copying a Quick Set.

Table 6-5 Address and Message Field Control — Scan to Email Quick Sets

Option	Description
Address Field Restrictions	Use the Address Field Restrictions drop-down list to specify whether users can type an email address or select an email address from an address book
From:	<p>Use the From: drop-down list to set the email address that displays in the From: field of the email.</p> <p>If Default From: is selected, the email address listed in the Default From: field is used.</p> <p>If User's address (sign-in required) is selected, the user is required to sign in to the printer with their email address when using the Quick Set.</p> <p>This field can be set to be user-editable.</p>
Default From:	The Default From: field is used to define the email address used when Default From: is selected in the From: drop-down list.
Default Display Name:	<p>Use this field to set the name displayed on the printer's control panel. If this field is not set, the value in the Default From: displays on the printer's control panel.</p> <p>This field is optional.</p>

Table 6-5 Address and Message Field Control — Scan to Email Quick Sets (continued)

Option	Description
To:	Use these drop-down lists to set the email recipient, CC (carbon copy) and BCC (blind carbon copy) values.
CC:	The options for each of these fields are:
BCC:	
	<ul style="list-style-type: none"> • User's address (sign-in required) • Blank • Specify address
	These fields can be set to be user-editable
Subject:	Use this field to set the value that appears in the subject line of the email.
	This field can be set to be user-editable.
Message:	Use this field to set the value for the body of the email.
	This field can be set to be user-editable.

Table 6-6 Signing and Encryption — Scan to Email Quick Sets

Option	Description
Signing	Use the Signing drop-down list to specify whether the email sent using the Quick Set is digitally signed.
	This field can be set to be user-editable.
Hashing Algorithm	Use the Hashing Algorithm drop-down list to set the type hashing algorithm used with signed emails. The following hashing algorithms are available:
	<ul style="list-style-type: none"> • SHA-1 • SHA-256 (recommended) • SHA-384 • SHA-512
Encryption	Use the Encryption drop-down list to specify whether the email sent using the Quick Set is encrypted.
	This field can be set to be user-editable.
Encryption Algorithm	Use the Encryption Algorithm drop-down list to set the encryption algorithm used for encrypted emails sent using the Quick Set.
Attribute for Recipient Public Key	The Attribute for Recipient Public Key field is used to set the attribute used for retrieving the email recipient's public key from LDAP for signed or encrypted emails.
Use the recipient public key certificate to verify the recipient	Select this setting to use the recipient's public key certificate to verify the recipient.

Table 6-7 Scan settings — Scan to Email, Scan to Fax, Scan to Network Folder, Scan to SharePoint®, and Scan to USB Quick Sets

Option	Description
Original Size	Specify the size for the original document.

Table 6-7 Scan settings — Scan to Email, Scan to Fax, Scan to Network Folder, Scan to SharePoint®, and Scan to USB Quick Sets (continued)

Option	Description
Original Sides	Select whether the original document is single-sided or double-sided.
Optimize Text/Picture	<p>Optimize the job for the type of image being scanned: text, graphics, or photos.</p> <p>Select from the following options:</p> <ul style="list-style-type: none"> • Text: Use for documents that contain mostly text • Mixed: Use for documents with a mix of text and pictures • Printed picture: Use for line drawings and preprinted images, such as magazine clippings or pages from books <p>NOTE: If bands of irregular intensity print on the copies, try selecting Printed picture to improve the quality.</p> <ul style="list-style-type: none"> • Photograph: Use for photographic prints
Content Orientation	<p>Select the way the content of the original document is placed on the page:</p> <ul style="list-style-type: none"> • Portrait: The short edge of the page is along the top. • Landscape: The long edge of the page is along the top.
Background Cleanup	Select a value to remove faint images from the background or to remove a light background color.
Darkness	Select a value to adjust the darkness of the file.
Contrast	Select a value to adjust the contrast of the file.
Sharpness	Select a value to adjust the sharpness of the file.
Image Preview	Select whether to require or make optional a displayed preview of the job or to disable a preview.
Cropping options (not available for Scan to Fax)	Select whether or not to allow a job to be cropped and the type of cropping option.
Erase Edges (not available for Scan to Fax)	Select this setting to specify the width of edge margins to be erased, in either inches or millimeters, for the front side and back side of a job.
Resolution (Scan to Fax only)	Set the resolution for the file. Higher resolution images have more dots per inch (dpi), so they show more detail. Lower resolution images have fewer dots per inch and show less detail, but the file size is smaller.
Suppress blank pages (Scan to Fax only)	If the Suppress blank pages option is enabled, blank pages will be ignored.

Table 6-8 File settings — Scan to Email, Scan to Network Folder, Scan to SharePoint®, and Scan to USB Quick Sets

Feature	Description
File Name Prefix	Set the default file name prefix used for files saved to a network folder.
File Name	<p>Default file name for the file to be saved.</p> <p>Select the User editable check box to make this setting editable at the printer control panel.</p>
File Name Suffix	<p>Set the default file name suffix used for files saved to a network folder.</p> <p>Duplicate filename suffix default [filename]_YYYYMMDDT</p>

Table 6-8 File settings — Scan to Email, Scan to Network Folder, Scan to SharePoint®, and Scan to USB Quick Sets (continued)

Feature	Description
File Name Preview	Enter a file name, and then click the Update Preview button.
File Numbering Format	Select a file name format for when the job is divided into multiple files.
Add numbering when job has just one file (ex. _1-1)	Select this setting to add numbering to a file name when the job is only one file instead of multiple files.
File Type	Select the file format for the saved file. Select the User editable check box to make this setting editable at the printer control panel.
High Compression (smaller file)	Select this setting to compress the scanned file, which reduces the file size. However, the scanning process for a High compression file might take longer than for a Normal compression file.
PDF encryption	If the file type is PDF, then this option encrypts the output PDF file. A password must be specified as part of the encryption. The same password must be used to open the file. The user will be prompted to enter a password prior to scanning their job if one has not been set prior to pressing start.
Resolution	Set the resolution for the file. Higher resolution images have more dots per inch (dpi), so they show more detail. Lower resolution images have fewer dots per inch and show less detail, but the file size is smaller.
Quality and File Size	Select the quality for the file. Higher-quality images require a larger file size than lower-quality images, and they take more time to send.
Color/Black	Specify whether copies are to be printed in color, black and gray, or black only.
Suppress blank pages	If the Suppress blank pages option is enabled, blank pages will be ignored.
Meta Data File Format (Scan to Network Folder Quick Sets only)	Use the drop-down list to select the file format for meta-data information. The options for this field are: <ul style="list-style-type: none"> • None • XML • HPS
Create Multiple Files	Select this setting to scan pages into separate files based on a predetermined maximum number of pages per file.

Table 6-9 Copy settings — Copy Quick Sets

Option	Description
Copies	Set the default number of copies.
Sides	Select a Sides option: <ul style="list-style-type: none"> • Original Sides <ul style="list-style-type: none"> – 1-sided – 2-sided • Output Sides <ul style="list-style-type: none"> – 1-sided – 2-sided

Table 6-9 Copy settings — Copy Quick Sets (continued)

Option	Description
Color/Black	<p>Specify whether copies are printed in color or in black and white:</p> <ul style="list-style-type: none"> • Automatically detect: Prints color documents in color (for printers that support color copying), and black and white documents in black and white. For mixed documents, the printer will determine whether to print in color or black and white. • Color: Prints documents in color (for printers that support color copying). • Black: Prints documents in black and white.
Reduce/Enlarge	<p>Use the Reduce/Enlarge feature to scale the size of the document up or down.</p> <p>Select a Reduce/Enlarge option:</p> <ul style="list-style-type: none"> • Automatic: The printer automatically scales the image to fit the paper size in the tray. • Manual: To reduce the image, type a scaling percentage that is less than 100. To enlarge the image, type a scaling percentage that is greater than 100.
Original Size	Specify the size for the original document.
Paper Selection	Select the paper size and type and which tray to use for the copies.
Booklet	Enable or disable Booklet Format, and select whether to Borders on each page .
Collate	<p>For printers that support print-job finishing, each set of copied pages are assembled in the same order as the original document.</p> <p>NOTE: If the printer has a stapler installed, select a staple option. To not staple the copies, select None.</p> <p>Select a Collate option:</p> <ul style="list-style-type: none"> • Collate on: If making more than one copy, select to assemble pages in the correct order for each set of copies. • Collate off: Select to group the same pages together. For example, if making five copies of an original document that has two pages, all five first pages are grouped together and all five second pages are grouped together.
Content Orientation	<p>Select the way the content of the original document is placed on the page:</p> <ul style="list-style-type: none"> • Portrait: The short edge of the page is along the top. • Landscape: The long edge of the page is along the top.
Pages per Sheet	<p>Select how many pages to print on one sheet and the page order: to copy to one, two, or four Pages per Sheet and select whether to Add page borders.</p> <p>Pages per Sheet</p> <ul style="list-style-type: none"> • One • Two • Four <p>Page Order</p> <ul style="list-style-type: none"> • Right, then down: Prints the pages in rows • Down, then right: Prints the pages in columns <p>Click the Add page borders check box to add borders on the pages.</p>

Table 6-9 Copy settings — Copy Quick Sets (continued)

Option	Description
Image Adjustment	<p>Use the settings to improve the overall quality of the copy. For example, adjust the Darkness and Sharpness, and use the Background Cleanup setting to remove faint images from the background or to remove a light background color.</p> <ul style="list-style-type: none"> • Darkness: Adjust to increase or decrease the amount of white and black in the colors • Contrast: Adjust to increase or decrease the difference between the lightest and darkest color on the page • Background Cleanup: Adjust if you are having trouble copying a faint image • Sharpness: Adjust to sharpen or soften the image. For example, increasing the sharpness could make text look clearer, but decreasing it could make photographs look smoother.
Optimize Text/Picture	<p>Optimize the job for the type of image being scanned: text, graphics, or photos.</p> <p>Select from the following options:</p> <ul style="list-style-type: none"> • Text: Use for documents that contain mostly text • Mixed: Use for documents with a mix of text and pictures • Printed picture: Use for line drawings and preprinted images, such as magazine clippings or pages from books <p>NOTE: If bands of irregular intensity print on the copies, try selecting Printed picture to improve the quality.</p> <ul style="list-style-type: none"> • Photograph: Use for photographic prints
Edge-to-Edge	<p>Use to avoid shadows that can display along the edges of copies when the original document is printed close to the edges.</p> <p>Combine this feature with the Reduce/Enlarge feature to ensure that the entire page is printed on the copies.</p> <p>When the Edge-to-Edge feature is turned on, the printer minimizes margins and prints as close to the edge of the paper as possible.</p>
Scan Mode	<p>Select the type of document to scan:</p> <ul style="list-style-type: none"> • Standard Document: Scan a page or stack of pages through the document feeder, or individually on the flatbed glass. • 2-sided ID: Scan each side of an identification card on the flatbed glass and output them onto one page. After scanning the first side, the printer prompts to place the second side in the correct position on the glass. • Book Mode: Scan an open book and output each page of the book onto different pages.
Erase Edges	<p>Select this setting to specify the width of edge margins to be erased, in either inches or millimeters, for the front side and back side of a job.</p>
Image Preview	<p>Select whether to require or make optional a displayed preview of the job or to disable a preview.</p>

Send a scanned document to one or more email addresses

Introduction

The printer has a feature that enables it to scan a document and send it to one or more email addresses. Before using this feature, use the HP Embedded Web Server to enable it and set it up.

Scan and send a document to email

1. Place the document face-down on the scanner glass, or place it face-up in the document feeder and adjust the paper guides to fit the size of the document.
2. From the Home screen on the printer control panel, select [Scan](#), and then select [Scan to Email](#).

 **NOTE:** If prompted, type your user name and password.

3. Touch the [To](#) field to open a keyboard.

 **NOTE:** If you are signed in to the printer, your user name or other default information might appear in the [From](#) field. If so, you might not be able to change it.

4. Specify the recipients by using one of these methods:

Enter addresses manually

- ▲ Enter the address in the [To](#) field. To send to multiple addresses, separate the addresses with a semicolon, or touch the Enter  button on the touchscreen keyboard after typing each address.

Enter addresses from the Contacts list

- a. Touch the Contacts  button that is next to the [To](#) field to open the [Contacts](#) screen.
 - b. From the drop-down list, select the appropriate contact list.
 - c. Select a name from the list of contacts to add the name to the recipients list. Repeat this step for each recipient, and then touch the [Done](#) button.
5. Complete the [Subject](#), and [File Name](#) fields by touching the field and using the touchscreen keyboard to enter information. Touch the [Done](#) button when you have completed the fields.
 6. To configure settings for the document, touch the [Options](#) button. For example:
 - Select [File Type and Resolution](#) to specify the type of file to create, the resolution, and the output quality.
 - If the original document is printed on both sides, select [Original Sides](#), and then select [2 Sided](#).
 7. Set options marked with a yellow triangle before using the preview feature.

 **NOTE:** After the preview scan, these options are removed from the main [Options](#) list and are summarized in the [Pre-scan Options](#) list. To change any of these options, discard the preview and start over.

Using the preview feature is optional.

8. Touch the right pane of the screen to preview the document. In the preview screen, use the buttons on the right of the screen to adjust the preview options and to rearrange, rotate, insert, or remove pages.



Use these buttons to toggle between single-page view and thumbnail view. More options are available in thumbnail view than in single-page view.



Use these buttons to zoom in or out on the selected page.

NOTE: Select only one page at a time to use these buttons.



Use this button to rotate the page 180 degrees.

NOTE: This button is available only in the thumbnail view.



Use this button to delete the selected pages.

NOTE: This button is available only in the thumbnail view.



Use these buttons to rearrange the pages within the document. Select one or more pages and move them to the left or right.

NOTE: These buttons are available only in the thumbnail view.



Use this button to add a page to the document. The printer prompts to scan additional pages.



Use this button to clear the changes made in the preview and start over.



Touch this button to collapse the preview screen and return to the Copy screen.

9. When the document is ready, touch the [Send](#) button.



NOTE: The printer might prompt you to add the email address to the contact list.

Scan and send to network folder

Introduction

The printer can scan a file and save it in a shared folder on the network. Before using this feature, use the HP Embedded Web server to enable the feature and configure the shared folders. The system administrator can configure pre-defined Quick Sets folders; otherwise it is necessary to specify the folder path for each job.

Scan and save the document to a folder

 **NOTE:** You might be required to sign in to the printer to use this feature.

1. Place the document face-down on the scanner glass, or place it face-up in the document feeder and adjust the paper guides to fit the size of the document.
2. From the Home screen on the printer control panel, select [Scan](#), and then select [Scan to Network Folder](#).
3. To specify a path for this job only, touch the [Folder Paths](#) text field to open a keyboard, and type the path to the folder, and then touch the Enter  button. Use this format for the path:

`\\server\folder`, where “server” is the name of the server that hosts the shared folder, and “folder” is the name of the shared folder. If the folder is nested inside other folders, complete all necessary segments of the path to reach the folder. For example: `\\server\folder\folder`

Or, touch the [Add a Path](#) button that is below the [Folder Paths](#) field to select a pre-defined Quick Sets path or a path associated with a Contact.

 **NOTE:** The [Folder Paths](#) field might have a pre-defined path, and it might not be editable. In this situation, the administrator has configured this folder for common access.

4. Touch the [File Name](#) text field to open a keyboard, and then type the name for the file, and then touch the Enter  button.
5. To configure settings for the document, touch the [Options](#) button. For example:
 - Select [File Type and Resolution](#) to specify the type of file to create, the resolution, and the output quality.
 - If the original document is printed on both sides, select [Original Sides](#), and then select [2 Sided](#).
6. Set options marked with a yellow triangle before using the preview feature.

 **NOTE:** After the preview scan, these options are removed from the main [Options](#) list and are summarized in the [Pre-scan Options](#) list. To change any of these options, discard the preview and start over.

Using the preview feature is optional.

7. Touch the right pane of the screen to preview the document. In the preview screen, use the buttons on the right of the screen to adjust the preview options and to rearrange, rotate, insert, or remove pages.



Use these buttons to toggle between single-page view and thumbnail view. More options are available in thumbnail view than in single-page view.



Use these buttons to zoom in or out on the selected page.

NOTE: Select only one page at a time to use these buttons.



Use this button to rotate the page 180 degrees.

NOTE: This button is available only in the thumbnail view.



Use this button to delete the selected pages.

NOTE: This button is available only in the thumbnail view.



Use these buttons to rearrange the pages within the document. Select one or more pages and move them to the left or right.

NOTE: These buttons are available only in the thumbnail view.



Use this button to add a page to the document. The printer prompts to scan additional pages.



Use this button to clear the changes made in the preview and start over.



Touch this button to collapse the preview screen and return to the Copy screen.

8. When the document is ready, touch **Scan** to save the file.

Scan and send to USB Flash Drive

Introduction

The printer can scan a file and save it on a USB flash drive. Before using this feature, use the HP Embedded Web server to enable and configure it.

Scan and save the document to a USB flash drive

 **NOTE:** You might be required to sign in to the printer to use this feature.

1. Place the document face-down on the scanner glass, or place it face-up in the document feeder and adjust the paper guides to fit the size of the document.
2. Insert the USB flash drive into the USB port near the printer control panel.
3. From the Home screen on the printer control panel, select [Scan](#), and then select [Scan to USB Drive](#).
4. From the [Save As...](#) list, select the flash drive. Save the file on the root of the USB flash drive, or save it in an existing folder.
5. Touch the [File Name](#) text field to open a keyboard, and then type the name for the file, and then touch the Enter  button.
6. To configure settings for the document, touch the [Options](#) button. For example:
 - Select [File Type and Resolution](#) to specify the type of file to create, the resolution, and the output quality.
 - If the original document is printed on both sides, select [Original Sides](#), and then select [2 Sided](#).
7. Set options marked with a yellow triangle before using the preview feature.

 **NOTE:** After the preview scan, these options are removed from the main [Options](#) list and are summarized in the [Pre-scan Options](#) list. To change any of these options, discard the preview and start over.

Using the preview feature is optional.

8. Touch the right pane of the screen to preview the document. In the preview screen, use the buttons on the right of the screen to adjust the preview options and to rearrange, rotate, insert, or remove pages.



Use these buttons to toggle between single-page view and thumbnail view. More options are available in thumbnail view than in single-page view.





Use these buttons to zoom in or out on the selected page.

NOTE: Select only one page at a time to use these buttons.



Use this button to rotate the page 180 degrees.

NOTE: This button is available only in the thumbnail view.



Use this button to delete the selected pages.

NOTE: This button is available only in the thumbnail view.



Use these buttons to rearrange the pages within the document. Select one or more pages and move them to the left or right.

NOTE: These buttons are available only in the thumbnail view.



Use this button to add a page to the document. The printer prompts to scan additional pages.



Use this button to clear the changes made in the preview and start over.



Touch this button to collapse the preview screen and return to the Copy screen.

9. When the document is ready, touch [Scan](#) to save the file.

Additional options when scanning

The following settings are available in the [Options](#) list when scanning.



NOTE: The following list contains the master set of options available for HP LaserJet Enterprise MFP printers. Some options are not available on all printers.

File Type and Resolution	<p>Save a scanned document as one of several types of files.</p> <p>The following standard file types are available:</p> <ul style="list-style-type: none">• PDF: This file type provides the best overall image and text quality. PDF files require Adobe® Acrobat® Reader software for viewing.• JPEG: This file type is a good choice for most graphics. Most computers have a browser that can view .JPEG files. This file type produces one file per page.• TIFF: This is a standard file type that many graphics programs support. This file type produces one file per page.• MTIFF: MTIFF stands for multi-page TIFF. This file type saves multiple scanned pages in a single file.• XPS: XPS (XML Paper Specification) creates an XAML file that preserves the original formatting of the document and supports color graphics and embedded fonts.• PDF/A: PDF/A is a type of PDF designed for long-term archival of electronic documents. All format information in the document is self-contained. <p>HP LaserJet Enterprise Flow MFP printers or MFP printers that are connected to a digital send software (DSS) server also support the following OCR file types:</p> <ul style="list-style-type: none">• Text (OCR): Text (OCR) creates a text file by using optical character recognition (OCR) to scan the original. A text file can be opened in any word processing program. The formatting of the original will not be saved using this option.• Unicode Text (OCR): Unicode Text (OCR) is an industry standard used to consistently represent and manipulate text. This file type is useful for internationalization and localization.• RTF (OCR): RTF (OCR) creates a rich text format (RTF) file by using optical character recognition (OCR) to scan the original. RTF is an alternative text format that can be opened by most word processing programs. Some of the formatting of the original will be saved using this option.• Searchable PDF (OCR): Searchable PDF (OCR) creates a searchable PDF file by using optical character recognition (OCR) to scan the original. When a document is scanned in this way, use Adobe Acrobat® Reader's search tools to search for specific words or phrases within the PDF.• Searchable PDF/A (OCR): Searchable PDF/A (OCR) is a type of PDF/A file that includes information about the document structure, which allows content to be searched.• HTML (OCR): HTML (OCR) creates a Hypertext Markup Language (HTML) file containing the contents of the original document. HTML is used to display files on Web sites.• CSV (OCR): CSV (OCR) is common text file format that contains comma-separated values. This type of file can be opened by most word processing, spreadsheet, or database programs. <p>MFP printers that are connected to a DSS server also support the following OCR file types for digital send jobs:</p> <ul style="list-style-type: none">• XML (OCR): DESCRIPTION NEEDED.• Searchable XPS (OCR): DESCRIPTION NEEDED.
Original Sides	<p>Specify whether the original document is printed on one side or both sides.</p>

Color/Black	Specify whether the scanned image will be in color, black and gray, or black only. For color printers only.
Scan Mode	<p>Standard Document: Scan a page or stack of pages through the document feeder, or individually on the flatbed glass.</p> <p>Book Mode: Scan an open book and output each page of the book onto different pages.</p> <p>2-sided ID Copy: Scan each side of an identification card on the flatbed glass and output them onto one page. After scanning the first side, the printer prompts to place the second side in the correct position on the glass.</p>
Resolution	Specify the resolution of scanned images. Select a higher resolution to increase the clarity of the image. However, as the resolution increases, the file size also increases.
Original Size	Specify the paper size for the original document.
Content Orientation	Specify whether the original document is printed in Portrait or Landscape orientation.
Image Adjustment	<p>Sharpness: Clarify or soften the image. For example, increasing the sharpness could make text appear crisper, but decreasing it could make photos appear smoother.</p> <p>Darkness: Increase or decrease the amount of white and black used in colors in scanned images.</p> <p>Contrast: Increase or decrease the difference between the lightest and the darkest color on the page.</p> <p>Background Cleanup: Remove faint colors from the background of scanned images. For example, if the original document is printed on colored paper, use this feature to lighten the background without affecting the darkness of the image.</p> <p>Automatic Tone: Available for Flow printers only. For original documents that have at least 100 characters of text on the page, the printer can detect which edge is the top of the page, and it orients the scanned images appropriately. If some of the pages are upside-down in relation to the other pages, the resulting scanned image has all pages right-side-up. If some of the pages have a landscape orientation, the printer rotates the image so that the top of the page is at the top of the image.</p>
Optimize Text/Picture	Optimize the job for the type of image being scanned: text, graphics, or photos.
Erase Edges	Remove blemishes, such as dark borders or staple marks, by cleaning the edges of the scanned image.
Cropping Options	<p>Crop to original size: Crop the image to match the paper size of the original document.</p> <p>Crop to content: Crop the image to the size of the detectable content in the original document.</p>
Automatically Straighten	Automatically straighten a scanned image.
Blank Page Suppression	Exclude blank pages in the original document from scanned images. This feature is useful for scanning pages printed on both sides to eliminate blank pages in the resulting scanned document.
Multi-feed Detection	Enable or disable multi-feed detection. When enabled, scanning stops when the printer detects more than one page at a time being fed in the document feeder. When disabled, scanning continues when a multi-feed is detected, to allow scanning pages that are stuck together, originals with self-adhesive notes on them, or thick paper.
Create Multiple Files	Divide a larger scan job into several smaller output files.
Notification	Select whether to send notifications of the status of scan jobs. The printer can print the notification, or it can send the notification in an email.
Signing and Encryption	<p>Sign: Send an email with a digital signature.</p> <p>Encrypt: Send an email as an encrypted file.</p> <p>NOTE: This feature is supported for scan to email only.</p>

HP JetAdvantage business solutions

HP JetAdvantage solutions are workflow and printing solutions that are easy-to-use, and both network and cloud-based. HP JetAdvantage solutions are designed to help businesses of all types, including healthcare, financial services, manufacturing, and public sector, manage a fleet of printers and scanners.

HP JetAdvantage Solutions include:

- HP JetAdvantage Security solutions
- HP JetAdvantage Management solutions
- HP JetAdvantage Workflow solutions
- HP JetAdvantage Mobile Printing solutions

For more information about HP JetAdvantage business workflow and printing solutions, go to www.hp.com/go/PrintSolutions.

Additional scan tasks

Go to www.hp.com/support/ljM631MFP, www.hp.com/support/ljM632MFP, or www.hp.com/support/ljM633MFP.

Instructions are available for performing specific scan tasks, such as the following:

- Copy or scan pages from books or other bound documents
- Send a scanned document to a folder in the printer memory
- Copy or scan both sides of an identification card
- Copy or scan a document into a booklet format

7 Fax

- [Set up fax](#)
- [Change fax configurations](#)
- [Send a fax](#)
- [Additional options when faxing](#)
- [Additional fax tasks](#)

For more information:

The following information is correct at the time of publication. For current information, see www.hp.com/support/ljM631MFP, www.hp.com/support/ljM632MFP, or www.hp.com/support/ljM633MFP.

HP's all-inclusive help for the printer includes the following information:

- Install and configure
- Learn and use
- Solve problems
- Download software and firmware updates
- Join support forums
- Find warranty and regulatory information

Set up fax

Introduction

This information applies to fax and Flow models, or to other printers when an optional analog fax accessory has been installed. Before continuing, connect the printer to a phone line (for analog fax) or to an Internet or network fax service.

Set up fax by using the printer control panel

1. From the Home screen on the printer control panel, swipe until the [Settings](#) menu displays. Touch the [Settings](#) icon to open the menu.
2. Open the following menus:
 - [Fax](#)
 - [Internal Fax Modem Setup](#)



NOTE: If the [Internal Fax Modem Setup](#) menu does not appear in the menu listing, LAN or Internet fax might be enabled. When LAN or Internet fax is enabled, the analog fax accessory is disabled and the [Internal Fax Modem Setup](#) menu does not display. Only one fax feature, either LAN fax, analog fax, or Internet fax, can be enabled at a time. To use analog fax when LAN fax is enabled, use the HP Embedded Web Server to disable LAN fax.

3. Select the location from the list on the right side of the screen, and then touch [Next](#).
4. Touch the [Company Name](#) text field, and use the keypad to type the company name.
5. Touch the [Fax Number](#) text field, and use the keypad to type the sending fax number. Touch [Next](#).
6. Verify that the date and time settings are correct. Make changes as necessary, and then touch [Next](#).
7. If a dialing prefix is required for sending faxes, touch the [Dialing Prefix](#) text field, and use the keypad to enter the number.
8. Review all the information on the left pane, and then touch [Finish](#) to complete the fax setup.

Change fax configurations

 **NOTE:** The settings configured using the control panel override any settings made in the HP Embedded Web Server.

- [Fax dialing settings](#)
- [General fax send settings](#)
- [Fax receive settings](#)

Fax dialing settings

1. From the Home screen on the printer control panel, swipe until the [Settings](#) menu displays. Touch the [Settings](#) icon to open the menu.
2. Open the following menus:
 - [Fax](#)
 - [Fax Send Settings](#)
 - [Fax Dialing Settings](#)

Configure any of the following settings:

Menu item	Description
Redial on Error	The Redial on Error feature sets the number of times a fax number will be redialed when an error occurs during a fax transmission.
Redial on No Answer	The Redial on No Answer setting selects the number of times the fax accessory redials if the number dialed does not answer. The number of retries is either 0 to 1 (used in the U.S.) or 0 to 2, depending on the location setting. The interval between retries is set by the redial interval setting.
Redial on Busy	The Redial on Busy setting selects the number of times (0 through 9) the fax accessory redials a number when the number is busy. The interval between retries is set by the Redial Interval setting.
Redial Interval	<p>The Redial Interval setting selects the number of minutes between retries if the number dialed is busy or not answering, or if an error occurs.</p> <p>NOTE: You might observe a redial message on the control panel when both the Redial on Busy and Redial on No Answer settings are set to off. This occurs when the fax accessory dials a number, establishes a connection, and then loses the connection. As a result of this error condition, the fax accessory performs three automatic redial attempts regardless of the redial settings. During this redial operation, a message displays on the control panel to indicate that a redial is in progress.</p>
Fax Send Speed	<p>The Fax Send Speed setting sets the modem bit rate (measured in bits per second) of the Analog Fax modem while sending a fax.</p> <ul style="list-style-type: none">• Fast (v.34 – 33.6k)• Medium (v.17 – 14.4k)• Slow (v.29 – 9.6k)
Line Monitor Volume	Use the Line Monitor Volume setting to control the printer's dialing volume level when sending faxes.

Menu item	Description
Dialing Mode	The Dialing Mode setting sets the type of dialing that is used: either tone (touch-tone phones) or pulse (rotary-dial phones).
Dialing Prefix	The Dialing Prefix setting allows you to enter a prefix number (such as a "9" to access an outside line) when dialing. This prefix number is automatically added to all phone numbers when dialed.
Detect dial tone	The Detect dial tone setting determines whether the fax checks for a dial tone before sending a fax.

General fax send settings

- From the Home screen on the printer control panel, swipe until the [Settings](#) menu displays. Touch the [Settings](#) icon to open the menu.
- Open the following menus:
 - [Fax](#)
 - [Fax Send Settings](#)
 - [General Fax Send Settings](#)

Configure any of the following settings:

Menu item	Description
Fax Number Confirmation	When the Fax Number Confirmation feature is enabled, the fax number must be entered twice to ensure that it was entered correctly. The feature is disabled by default.
PC Fax Send	Use the PC Fax Send feature to send faxes from a PC. This feature is enabled by default.
Error Correction Mode	<p>Normally, the fax accessory monitors the signals on the telephone line while it is sending or receiving a fax. If the fax accessory detects an error during the transmission and the Error Correction Mode setting is on, the fax accessory can request that the error portion of the fax be sent again.</p> <p>The Error Correction Mode feature is enabled by default. You should turn it off only if you are having trouble sending or receiving a fax and if you are willing to accept the errors in the transmission and a probable quality reduction in the image. Turning off the setting might be useful when you are trying to send a fax overseas or receive one from overseas, or if you are using a satellite telephone connection.</p> <p>NOTE: Some VoIP providers might suggest turning off the Error Correction Mode setting. However, this is not usually necessary.</p>
Fax Header	Use the Fax Header feature to control whether the header is appended to the top, and content is shifted down, or if the header is overlaid on top of the previous header.

Fax receive settings

- From the Home screen on the printer control panel, swipe until the [Settings](#) menu displays. Touch the [Settings](#) icon to open the menu.
- Open the following menus:

- [Fax](#)
- [Fax Receive Settings](#)
- [Fax Receive Setup](#)

Configure any of the following settings:

Menu item	Description
Receive Mode	<p>The Receive Mode setting determines how the fax accessory receives fax jobs. Select one of the following options:</p> <ul style="list-style-type: none"> • Automatic • TAM • Fax/Tel • Manual
Rings to Answer	<p>The Rings to Answer setting determines the number of times the phone rings before the call is answered by the fax accessory.</p> <p>NOTE: The default range for the available options for the Rings to Answer setting is location-specific. The range of possible Rings to Answer options is limited by location.</p> <p>If the fax accessory is not answering, and the Rings to Answer setting is 1, try increasing it to 2.</p>
Ring Volume	Touch the Ring Volume drop-down menu and adjust the ringer volume settings.
Ring Volume	The Ring Volume setting allows you to adjust the ringer volume.
Fax Receive Speed	<p>Touch the Fax Receive Speed drop down menu and select one of the following options:</p> <ul style="list-style-type: none"> • Fast (v.34 – 33.6k) • Medium (v.17 – 14.4k) • Slow (v.29 – 9.6k)
Extension Phone	This setting allows you use a separate telephone in conjunction with the fax functions.
Allow Reprinting	This setting allows to reprint received faxes.
Receive to PC	This setting allows you to receive faxes directly to your computer.
Fax Polling	This setting allows you to enable or disable the fax polling function.
Fax/Tel Ring Time	This setting determines the number of times the phone rings before the fax/tel mode initiates.

Send a fax

1. Place the document face-down on the scanner glass, or place it face-up in the document feeder and adjust the paper guides to fit the size of the document.
2. From the Home screen on the printer control panel, select [Scan](#), and then select [Scan to Fax](#). You might be prompted to type a user name and password.
3. Specify the recipients by using one of these methods:

Enter recipients manually

- ▲ Touch the [Fax Recipients](#) text field, and then use the keypad to enter the fax number. To send to multiple addresses, separate the addresses with a semicolon, or touch the Enter  button on the touchscreen keyboard after typing each address.

Enter recipients from the Contacts list

- a. Touch the Contacts  button that is next to the [Fax Recipients](#) field to open the [Contacts](#) screen.
 - b. From the drop-down list, select the appropriate contact list.
 - c. Select a name from the list of contacts to add the name to the recipients list. Repeat this step for each recipient, and then touch the [Done](#) button.
4. To configure settings for the document, touch the [Options](#) button. For example:
 - Select [Resolution](#) to specify the resolution for the fax.
 - If the original document is printed on both sides, select [Original Sides](#), and then select [2 Sided](#).
 5. Set options marked with a yellow triangle before using the preview feature.

 **NOTE:** After the preview scan, these options are removed from the main [Options](#) list and are summarized in the [Pre-scan Options](#) list. To change any of these options, discard the preview and start over.

Using the preview feature is optional.

6. Touch the right pane of the screen to preview the document. In the preview screen, use the buttons on the right of the screen to adjust the preview options and to rearrange, rotate, insert, or remove pages.



Use these buttons to toggle between single-page view and thumbnail view. More options are available in thumbnail view than in single-page view.



Use these buttons to zoom in or out on the selected page.

NOTE: Select only one page at a time to use these buttons.





Use this button to rotate the page 180 degrees.

NOTE: This button is available only in the thumbnail view.



Use this button to delete the selected pages.

NOTE: This button is available only in the thumbnail view.



Use these buttons to rearrange the pages within the document. Select one or more pages and move them to the left or right.

NOTE: These buttons are available only in the thumbnail view.



Use this button to add a page to the document. The printer prompts to scan additional pages.



Use this button to clear the changes made in the preview and start over.



Touch this button to collapse the preview screen and return to the Copy screen.

7. When the document is ready, touch [Send](#) to send the fax.

Additional options when faxing

The following settings are available in the [Options](#) list when faxing.



NOTE: The following list contains the master set of options available for HP LaserJet Enterprise MFP printers. Some options are not available on all printers.

Original Sides	Specify whether the original document is printed on one side or both sides.
Resolution	Specify the resolution of scanned images. Select a higher resolution to increase the clarity of the image. However, as the resolution increases, the file size also increases.
Original Size	Specify the paper size for the original document.
Content Orientation	Specify whether the original document is printed in Portrait or Landscape orientation.
Image Adjustment	<p>Sharpness: Clarify or soften the image. For example, increasing the sharpness could make text appear crisper, but decreasing it could make photos appear smoother.</p> <p>Darkness: Increase or decrease the amount of white and black used in colors in scanned images.</p> <p>Contrast: Increase or decrease the difference between the lightest and the darkest color on the page.</p> <p>Background Cleanup: Remove faint colors from the background of scanned images. For example, if the original document is printed on colored paper, use this feature to lighten the background without affecting the darkness of the image.</p> <p>Automatic Tone: Available for Flow printers only. For original documents that have at least 100 characters of text on the page, the printer can detect which edge is the top of the page, and it orients the scanned images appropriately. If some of the pages are upside-down in relation to the other pages, the resulting scanned image has all pages right-side-up. If some of the pages have a landscape orientation, the printer rotates the image so that the top of the page is at the top of the image.</p>
Optimize Text/Picture	Optimize the job for the type of image being scanned: text, graphics, or photos.
Erase Edges	Remove scan defects such as dark borders, staple marks, or hole-punch marks by “erasing” the specified edges of the scan job.
NOTE: This feature is not available for all firmware versions. You might need to update the printer firmware to use this feature.	
Blank Page Suppression	Exclude blank pages in the original document from scanned images. This feature is useful for scanning pages printed on both sides to eliminate blank pages in the resulting scanned document.
Multi-feed Detection	Enable or disable multi-feed detection. When enabled, scanning stops when the printer detects more than one page at a time being fed in the document feeder. When disabled, scanning continues when a multi-feed is detected, to allow scanning pages that are stuck together, originals with self-adhesive notes on them, or thick paper.
Notification	Select whether to send notifications of the status of scan jobs. The printer can print the notification, or it can send the notification in an email.

Additional fax tasks

Go to www.hp.com/support/ljM631MFP, www.hp.com/support/ljM632MFP, or www.hp.com/support/ljM633MFP.

Instructions are available for performing specific fax tasks, such as the following:

- Create and manage fax speed dial lists
- Configure fax billing codes
- Use a fax printing schedule
- Block incoming faxes
- Fax archiving and forwarding

8 Manage the printer

- [Advanced configuration with HP Embedded Web Server \(EWS\)](#)
- [Configure IP network settings](#)
- [Printer security features](#)
- [Energy-conservation settings](#)
- [HP Web Jetadmin](#)
- [Software and firmware updates](#)

For more information:

The following information is correct at the time of publication. For current information, see www.hp.com/support/ljM631MFP, www.hp.com/support/ljM632MFP, or www.hp.com/support/ljM633MFP.

HP's all-inclusive help for the printer includes the following information:

- Install and configure
- Learn and use
- Solve problems
- Download software and firmware updates
- Join support forums
- Find warranty and regulatory information

Advanced configuration with HP Embedded Web Server (EWS)

- [Introduction](#)
- [How to access the HP Embedded Web Server \(EWS\)](#)
- [HP Embedded Web Server features](#)

Introduction

Use the HP Embedded Web Server to manage printing functions from a computer instead of the printer control panel.

- View printer status information
- Determine the remaining life for all supplies and order new ones
- View and change tray configurations
- View and change the printer control-panel menu configuration
- View and print internal pages
- Receive notification of printer and supplies events
- View and change network configuration



The HP Embedded Web Server works when the printer is connected to an IP-based network. The HP Embedded Web Server does not support IPX-based printer connections. Internet access is not needed to open and use the HP Embedded Web Server.

When the printer is connected to the network, the HP Embedded Web Server is automatically available.



NOTE: The HP Embedded Web Server is not accessible beyond the network firewall.

How to access the HP Embedded Web Server (EWS)

1. From the Home screen on the printer control panel, touch the Information  icon, and then touch the Network  icon to display the IP address or host name.
2. Open a Web browser, and in the address line, type the IP address or host name exactly as it displays on the printer control panel. Press the **Enter** key on the computer keyboard. The EWS opens.

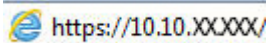
A screenshot of a web browser's address bar showing the URL "https://10.10.XXXX/". The address bar has a blue border and a small icon on the left.

NOTE: If the Web browser displays a message indicating that accessing the website might not be safe, select the option to continue to the website. Accessing this website will not harm the computer.

To use the HP Embedded Web Server, the browser must meet the following requirements:

Windows® 7

- Internet Explorer (version 8.x or greater)
- Google Chrome (version 34.x or greater)
- Firefox (version 20.x or greater)

Windows® 8 or greater

- Internet Explorer (version 9.x or greater)
- Google Chrome (version 34.x or greater)
- Firefox (version 20.x or greater)

OS X

- Safari (version 5.x or greater)
- Google Chrome (version 34.x or greater)

Linux

- Google Chrome (version 34.x or greater)
- Firefox (version 20.x or greater)

HP Embedded Web Server features

- [Information tab](#)
- [General tab](#)
- [Copy/Print tab](#)
- [Scan/Digital Send tab](#)
- [Fax tab](#)
- [Troubleshooting tab](#)
- [Security tab](#)
- [HP Web Services tab](#)
- [Networking tab](#)
- [Other Links list](#)

Information tab

Table 8-1 HP Embedded Web Server Information tab

Menu	Description
Device Status	Shows the printer status and shows the estimated life remaining of HP supplies. The page also shows the type and size of paper set for each tray. To change the default settings, click the Change Settings link.
Job Log	Shows a summary of all jobs the printer has processed.
Configuration Page	Shows the information found on the configuration page.
Supplies Status Page	Shows the status of the supplies for the printer.
Event Log Page	Shows a list of all printer events and errors. Use the HP Instant Support link (in the page footer on all HP Embedded Web Server pages) to connect to a set of dynamic Web pages that help solve problems. These pages also show additional services available for the printer.

Table 8-1 HP Embedded Web Server Information tab (continued)

Menu	Description
Usage Page	Shows a summary of the number of pages the printer has printed, grouped by size, type, and paper print path.
Device Information	Shows the printer network name, address, and model information. To customize these entries, click the Device Information menu on the General tab.
Control Panel Snapshot	Shows an image of the current screen on the control panel display.
Print	Upload a print-ready file from the computer to print. The printer uses the default print settings to print the file.
Printable Reports and Pages	Lists the internal reports and pages for the printer. Select one or more items to print or view.
Open Source Licenses	Shows a summary of the licenses for open source software programs that can be used with the printer.

General tab

Table 8-2 HP Embedded Web Server General tab

Menu	Description
Control Panel Customization	Reorder, show, or hide features on the control-panel display. Change the default display language and keyboard layouts.
Quick Sets Setup	Configure jobs that are available in the Quick Sets area of the Home screen on the printer control panel.
Alerts	Setup email alerts for various printer and supplies events.
Control Panel Administration Menu	Shows the menu structure of the Administration menu on the control panel. NOTE: Configure settings on this screen, or the HP Embedded Web Server provides more advanced configuration options than are available through the Administration menu.
General Settings	Configure how the printer recovers from jams and whether copy jobs initiated at the printer control panel take priority over print jobs.
AutoSend	Configure the printer to send automated emails regarding printer configuration and supplies to specific email addresses.
Edit Other Links	Add or customize a link to another Web site. This link displays in the footer area on all HP Embedded Web Server pages.
Ordering Information	Enter information about ordering replacement cartridges. This information displays on the supplies status page.
Device Information	Name the printer and assign an asset number to it. Enter the name of the primary contact who will receive information about the printer.
Language	Set the language in which to display the HP Embedded Web Server information.
Date/Time Settings	Set the date and time or synchronize with a network time server.
Energy Settings	Set or edit sleep settings for business and non-business hours and wake, sleep, and holiday events for the printer. Set which interactions with the printer cause it to wake from sleep mode.

Table 8-2 HP Embedded Web Server General tab (continued)

Menu	Description
Backup and Restore	Create a backup file that contains printer and user data. If necessary, use this file to restore data to the printer.
Reset Factory Settings	Restore printer settings to the factory defaults.
Solution Installer	Install third-party software packages that extend or modify the functionality of the printer.
Firmware Upgrade	Download and install printer firmware upgrade files.
Quota and Statistics Services	Provides connection information about third-party job-statistics services.

Copy/Print tab

Table 8-3 HP Embedded Web Server Copy/Print tab

Menu	Description
Print from USB Drive Settings	Enable or disable the Print from USB Drive menu on the control panel.
Manage Stored Jobs	Enable or disable the ability to store jobs in the printer memory. Configure job-storage options.
Default Print Options	Configure the default options for print jobs.
Restrict Color (Color printers only)	Permit or restrict color printing and copying. Specify permissions for individual users or for jobs that are sent from specific software programs.
PCL and PostScript Settings	Adjust the PCL and PostScript settings for all print jobs, including copy jobs and received faxes.
Print Quality	Configure the print quality settings, including the following: <ul style="list-style-type: none"> • General print-quality settings • Default color settings • Default image registration settings • Auto sense behavior • Default paper types • Default optimization settings
Manage Supplies	Configure how the printer reacts when supplies reach a Very Low state.
Copy Settings	Configure the default options for copy jobs. NOTE: If job-specific copy setting options are not set from the control panel at the start of a job, the default settings will be used for the job.
Manage Trays	Configure settings for paper trays.

Scan/Digital Send tab

Table 8-4 HP Embedded Web Server Scan/Digital Send tab

Menu	Description
Email Setup	Configure the default email settings for digital sending, including the following: <ul style="list-style-type: none">• Settings for the outgoing mail (SMTP) server• Settings for Email Quick Sets jobs• Default message settings, such as the "From" address and the subject line• Settings for digital signatures and encryption• Settings for email notifications• Default scan settings for email jobs• Default file settings for email jobs
Save to Network Folder	Configure the network folder settings for digital sending, including the following: <ul style="list-style-type: none">• Settings for Quick Sets jobs saved in a network folder• Settings for notifications• Default scan settings for jobs saved in a network folder• Default file settings for jobs saved in a network folder
Save to SharePoint® (Flow models only)	Configure the Microsoft SharePoint® settings for digital sending, including the following: <ul style="list-style-type: none">• Settings for Quick Sets jobs saved in a document library on the SharePoint® site• Default settings for jobs saved in a document library on the SharePoint® site
Scan to USB Drive	Configure the USB settings for digital sending, including the following: <ul style="list-style-type: none">• Settings for Quick Sets jobs saved on a USB flash drive• Settings for notifications• Default scan settings for jobs saved on a USB flash drive• Default file settings for jobs saved on a USB flash drive
Contacts	Manage contacts, including the following: <ul style="list-style-type: none">• Add email addresses into the printer one at a time.• Import a large list of frequently-used email addresses on to the printer all at once, rather than adding them one at a time.• Export contacts from the printer into a .CSV file on the computer to use as a data backup, or import the records onto another HP printer.• Edit email addresses that have already been saved in the printer.
Email and Save to Network Folder Quick Setup Wizards	Configure the printer to send scanned images as email attachments. Configure the printer to save scanned images to network-folder Quick Sets. Quicks Sets provide easy access to files saved on the network.
Digital Sending Software Setup	Configure settings related to using optional Digital Sending software.

Fax tab

Table 8-5 HP Embedded Web Server Fax tab

Menu	Description
Fax Send Setup	Configure settings for sending faxes, including the following: <ul style="list-style-type: none">• Default settings for outgoing faxes• Settings for fax Quick Sets jobs• Settings for notifications• Default setting for sending faxes using the internal fax modem• Settings for using a LAN fax service• Settings for using an Internet fax service
Fax Speed Dials	Manage speed dials, including the following: <ul style="list-style-type: none">• Import .CSV files containing email addresses, fax numbers, or user records, so that they can be accessed on this printer.• Export email, fax, or user records from the printer into a file on the computer to use as a data backup, or import the records onto another HP printer.
Fax Receive Setup	Configure default print options for incoming faxes, and set up a fax printing schedule.
Fax Archive and Forwarding	Enable or disable fax archiving and fax forwarding, and configure basic settings for each: <ul style="list-style-type: none">• Fax archiving is a method to send a copy of all incoming and outgoing faxes to an email address, a network folder, or an FTP server.• Fax forwarding is a method to forward incoming faxes to a different fax device.
Fax Activity Log	Contains a list of the faxes that have been sent from or received by this printer.

Troubleshooting tab

Table 8-6 HP Embedded Web Server Troubleshooting tab

Menu	Description
General Troubleshooting	Select from a variety of reports and tests to help solve problems with the printer. Configure settings for Fax, OXPd, and Auto Recovery.
Online Help	Link to HP cloud-based online help to assist in troubleshooting printing issues.
Retrieve Diagnostic Data	Export printer information to a file that can be useful for detailed problem analysis. NOTE: This item is available only if an administrator password is set from the Security tab.
Calibration/Cleaning (Color printers only)	Enable the automatic cleaning feature, create and print the cleaning page, and select an option to calibrate the printer immediately.
Firmware Upgrade	Download and install printer firmware upgrade files.
Reset Factory Settings	Reset printer settings to factory defaults.

Security tab

Table 8-7 HP Embedded Web Server Security tab

Menu	Description
General Security	Settings for general security, including the following: <ul style="list-style-type: none">• Configure an administrator password to restrict access to certain features on the printer.• Set PJI password for processing PJI commands.• Set file system access and firmware upgrade security.• Enable or disable the Host USB port on the control panel or the USB connectivity port on the formatter for printing directly from a computer.• View the status of all security settings.
Account Policy	Enable administrator account settings.
Access Control	Configure access to printer functions for specific individuals or groups, and select the method individuals use to sign in to the printer.
Protect Stored Data	Configure and manage the internal hard drive for the printer. This printer includes an encrypted hard drive for maximum security. Configure settings for jobs that are stored on the printer hard drive.
Certificate Management	Install and manage security certificates for access to the printer and the network.
Web Service Security	Allow resources on this printer to be accessed by web pages from different domains. If no sites are added to the list, then all sites are trusted.
Self Test	Verify that the security functions are running according to expected system parameters.

HP Web Services tab

Use the **HP Web Services** tab to configure and enable HP Web Services for this printer. It is necessary to Enable HP Web Services to use the HP ePrint feature.

Table 8-8 HP Embedded Web Server HP Web Services tab

Menu	Description
Web Services Setup	Connect this printer to HP's ePrintCenter on the Web by enabling HP Web Services.
Web Proxy	Configure a proxy server if there are issues enabling HP Web Services or connecting the printer to the Internet.
HP JetAdvantage	Access solutions that extend the capabilities of the printer

Networking tab

Use the **Networking** tab to configure and secure network settings for the printer when it is connected to an IP-based network. This tab does not display if the printer is connected to other types of networks.

Table 8-9 HP Embedded Web Server Networking tab

Menu	Description
Configuration	
Wireless Direct	<p>Configure Wireless Direct settings for printers that include embedded Wireless Direct printing or that have a wireless accessory installed.</p> <p>NOTE: The configuration options available depend on the print server model.</p>
TCP/IP Setting	<p>Configure TCP/IP settings for IPv4 and IPv6 networks.</p> <p>NOTE: The configuration options available depend on the print server model.</p>
Network Settings	Configure IPX/SPX, AppleTalk, DLC/LLC, and SNMP settings, depending on the print server model.
Other Settings	Configure general printing protocols and services supported by the print server. The available options depend on the print server model, but can include firmware update, LPD queues, USB settings, support information, and refresh rate.
AirPrint	Enable, set up, or disable network printing from Apple supported printers.
Select Language	Change the language displayed by the HP Embedded Web Server. This page displays if the Web pages support multiple languages. Optionally, select supported languages through language-preference settings in the browser.
Google Cloud Print	
Setup	Set up Google Cloud Print options.
Web Proxy	Configure proxy settings.
Security	
Settings	<p>View and restore current security settings to factory-default values.</p> <p>Configure security settings using the Security Configuration Wizard.</p> <p>NOTE: Do not use the Security Configuration Wizard to configure security settings using network-management applications, such as HP Web Jetadmin.</p>
Authorization	<p>Control configuration management and use of this printer, including the following:</p> <ul style="list-style-type: none"> • Set or change the administrator password to control access to configuration parameters. • Request, install, and manage digital certificates on the HP Jetdirect print server. • Limit host access to this printer through an Access Control List (ACL) (for selected print servers on IPv4 networks only).
Secure Communication	Configure security settings.
Mgmt. Protocols	<p>Configure and manage security protocols for this printer, including the following:</p> <ul style="list-style-type: none"> • Set the security management level for the HP Embedded Web Server, and control traffic over HTTP and HTTPS. • Configure the SNMP (Simple Network Management Protocol) operation. Enable or disable the SNMP v1/v2c or SNMP v3 agents on the print server. • Control access through protocols that may not be secure, such as printing protocols, print services, discovery protocols, name resolution services, and configuration-management protocols.

Table 8-9 HP Embedded Web Server Networking tab (continued)

Menu	Description
802.1X Authentication	Configure 802.1X authentication settings on the Jetdirect print server as required for client authentication on the network, and reset the 802.1X authentication settings to factory-default values. CAUTION: When changing the 802.1X authentication settings; the printer might lose its connection. To reconnect, it might be necessary to reset the print server to a factory-default state and reinstall the printer.
IPsec/Firewall	View or configure a Firewall policy or an IPsec/Firewall policy (for selected HP Jetdirect models only).
Announcement Agent	Enable or disable the HP Device Announcement Agent, set the configuration server, and configure mutual authentication using certificates.
Diagnostics	
Network Statistics	Display network statistics that are collected and stored on the HP Jetdirect print server.
Protocol Info	View a list of network-configuration settings on the HP Jetdirect print server for each protocol.
Configuration Page	View the HP Jetdirect configuration page, which contains status and configuration information.

Other Links list



NOTE: Configure which links display in the footer of the HP Embedded Web Server by using the **Edit Other Links** menu on the **General** tab. The following are the default links.

Table 8-10 HP Embedded Web Server Other Links list

Menu	Description
Product Support	Connect to the support site for the printer to search for help on various topics.
Shop for Supplies	Connect to the HP SureSupply website for information on purchasing original HP supplies, such as cartridges and paper.
HP Instant Support	Connect to the HP website to find solutions to printer problems.

Configure IP network settings



- [Printer sharing disclaimer](#)
- [View or change network settings](#)
- [Rename the printer on a network](#)
- [Manually configure IPv4 TCP/IP parameters from the control panel](#)
- [Manually configure IPv6 TCP/IP parameters from the control panel](#)
- [Link speed and duplex settings](#)

Printer sharing disclaimer

HP does not support peer-to-peer networking, as the feature is a function of Microsoft operating systems and not of the HP printer drivers. Go to Microsoft at www.microsoft.com.

View or change network settings

Use the HP Embedded Web Server to view or change IP configuration settings.

1. Open the HP Embedded Web Server (EWS):
 - a. From the Home screen on the printer control panel, touch the Information  icon, and then touch the Network  icon to display the IP address or host name.
 - b. Open a Web browser, and in the address line, type the IP address or host name exactly as it displays on the printer control panel. Press the **Enter** key on the computer keyboard. The EWS opens.

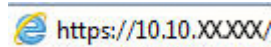



 **NOTE:** If the Web browser displays a message indicating that accessing the website might not be safe, select the option to continue to the website. Accessing this website will not harm the computer.

2. Click the **Networking** tab to obtain network information. Change settings as needed.

Rename the printer on a network

To rename the printer on a network so that it can be uniquely identified, use the HP Embedded Web Server.

1. Open the HP Embedded Web Server (EWS):
 - a. From the Home screen on the printer control panel, touch the Information  icon, and then touch the Network  icon to display the IP address or host name.
 - b. Open a Web browser, and in the address line, type the IP address or host name exactly as it displays on the printer control panel. Press the **Enter** key on the computer keyboard. The EWS opens.

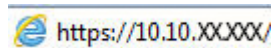

 **NOTE:** If the Web browser displays a message indicating that accessing the website might not be safe, select the option to continue to the website. Accessing this website will not harm the computer.

2. Open the **General** tab.

3. On the **Device Information** page, the default printer name is in the **Device Name** field. You can change this name to uniquely identify this printer.



NOTE: Completing the other fields on this page is optional.

4. Click the **Apply** button to save the changes.

Manually configure IPv4 TCP/IP parameters from the control panel

Use the control-panel [Settings](#) menus to manually set an IPv4 address, subnet mask, and default gateway.

1. From the Home screen on the printer control panel, swipe until the [Settings](#) menu displays. Touch the [Settings](#) icon to open the menu.
2. Open the following menus:
 - [Networking](#)
 - [Ethernet](#)
 - [TCP/IP](#)
 - [IPV 4 Settings](#)
 - [Config Method](#)
3. Select the [Manual](#) option, and then touch the [Save](#) button.
4. Open the [Manual Settings](#) menu.
5. Touch the [IP Address](#), [Subnet Mask](#), or [Default Gateway](#) option.
6. Touch the first field to open a keypad. Enter the correct digits for the field, and then touch the [OK](#) button.
Repeat the process for each field, and then touch the [Save](#) button.

Manually configure IPv6 TCP/IP parameters from the control panel

Use the control-panel [Settings](#) menus to manually set an IPv6 address.

1. From the Home screen on the printer control panel, swipe until the [Settings](#) menu displays. Touch the [Settings](#) icon to open the menu.
2. To enable manual configuration, open the following menus:
 - [Networking](#)
 - [Ethernet](#)
 - [TCP/IP](#)
 - [IPV6 Settings](#)
3. Select [Enable](#), and then select [On](#).
4. Select the [Enable Manual Settings](#) option, and then touch the [Done](#) button.
5. To configure the address, open the [Address](#) menu, and then touch the field to open a keypad.

6. Use the keypad to enter the address, and then touch the **OK** button.
7. Touch **Save**.

Link speed and duplex settings

 **NOTE:** This information applies only to Ethernet networks. It does not apply to wireless networks.

The link speed and communication mode of the print server must match the network hub. For most situations, leave the printer in automatic mode. Incorrect changes to the link speed and duplex settings might prevent the printer from communicating with other network devices. To make changes, use the printer control panel.

 **NOTE:** The printer setting must match the setting for the network device (a network hub, switch, gateway, router, or computer).

 **NOTE:** Making changes to these settings causes the printer to turn off and then on. Make changes only when the printer is idle.

1. From the Home screen on the printer control panel, swipe until the **Settings** menu displays. Touch the **Settings** icon to open the menu.
2. Open the following menus:
 - **Networking**
 - **Ethernet**
 - **Link Speed**
3. Select one of the following options:
 - **Auto:** The print server automatically configures itself for the highest link speed and communication mode allowed on the network.
 - **10T Half:** 10 megabytes per second (Mbps), half-duplex operation
 - **10T Full:** 10 Mbps, full-duplex operation
 - **10T Auto:** 10 Mbps, automatic-duplex operation
 - **100TX Half:** 100 Mbps, half-duplex operation
 - **100TX Full:** 100 Mbps, full-duplex operation
 - **100TX Auto:** 100 Mbps, automatic-duplex operation
 - **1000T Full:** 1000 Mbps, full-duplex operation
4. Touch the **Save** button. The printer turns off and then on.

Printer security features

Introduction

The printer includes several security features to restrict who has access to configuration settings, to secure data, and to prevent access to valuable hardware components.



- [Security statements](#)
- [Assign an administrator password](#)
- [IP Security](#)
- [Lock the formatter](#)
- [Encryption support: HP High Performance Secure Hard Disks](#)

Security statements

The printer supports security standards and recommended protocols that help you keep the printer secure, protect critical information on your network, and simplify the way you monitor and maintain the printer.

Assign an administrator password

Assign an administrator password for access to the printer and the HP Embedded Web Server so that unauthorized users cannot change the printer settings.

1. Open the HP Embedded Web Server (EWS):
 - a. From the Home screen on the printer control panel, touch the Information  icon, and then touch the Network  icon to display the IP address or host name.
 - b. Open a web browser, and in the address line, type the IP address or host name exactly as it displays on the printer control panel. Press the **Enter** key on the computer keyboard. The EWS opens.

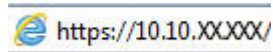

 **NOTE:** If the web browser displays a message indicating that accessing the website might not be safe, select the option to continue to the website. Accessing this website will not harm the computer.

2. Click the **Security** tab.
3. Open the **General Security** menu.
4. In the area labeled **Set the Local Administrator Password**, enter the name to associate with the password in the **Username** field.
5. Enter the password in the **New Password** field, and then enter it again in the **Verify Password** field.

 **NOTE:** To change an existing password, first enter the existing password in the **Old Password** field.

6. Click the **Apply** button.

 **NOTE:** Make note of the password and store it in a safe place. The administrator password cannot be recovered. If the administrator password is lost or forgotten, contact HP Support at support.hp.com for the assistance required to completely reset the printer.

Some features on the printer control panel can be secured so that unauthorized people cannot use them. When a feature is secured, the printer prompts you to sign in before you can use it. You can also sign in without waiting for a prompt by selecting [Sign In](#) from the printer control panel.

Typically, the credentials for signing in to the printer are the same as for signing in to the network. Consult the network administrator for this printer if you have questions about which credentials to use.

1. From the Home screen on the printer control panel, select [Sign In](#).
2. Follow the prompts to enter the credentials.

 **NOTE:** To maintain security for the printer, select [Sign Out](#) when you have finished using the printer.

IP Security

IP Security (IPsec) is a set of protocols that control IP-based network traffic to and from the printer. IPsec provides host-to-host authentication, data integrity, and encryption of network communications.

For printers that are connected to the network and have an HP Jetdirect print server, you can configure IPsec by using the **Networking** tab in the HP Embedded Web Server.

Lock the formatter

The formatter has a slot that you can use to attach a security cable. Locking the formatter prevents someone from removing valuable components from it.

Encryption support: HP High Performance Secure Hard Disks

The hard disk provides hardware-based encryption so you can securely store sensitive data without impacting printer performance. This hard disk uses the latest Advanced Encryption Standard (AES) and has versatile time-saving features and robust functionality.

Use the **Security** menu in the HP Embedded Web Server to configure the disk.

Energy-conservation settings

Introduction

- [Print with EconoMode](#)
- [Set the sleep timer and configure the printer to use 1 watt or less of power](#)
- [Set the sleep schedule](#)

Print with EconoMode

This printer has an EconoMode option for printing drafts of documents. Using EconoMode can use less toner. However, using EconoMode can also reduce print quality.

HP does not recommend the full-time use of EconoMode. If EconoMode is used full-time, the toner supply might outlast the mechanical parts in the toner cartridge. If print quality begins to degrade and is no longer acceptable, consider replacing the toner cartridge.



NOTE: If this option is not available in the print driver, set it using the printer control panel.

Configure EconoMode from the print driver

1. From the software program, select the **Print** option.
2. Select the printer, and then click the **Properties** or **Preferences** button.
3. Click the **Paper/Quality** tab.
4. Click the **EconoMode** check box to enable the feature, and then click **OK**.

Configure EconoMode from the printer control panel

1. From the Home screen on the printer control panel, open the [Settings](#) menu.
2. Open the following menus:
 - [Copy/Print](#) or [Print](#)
 - [Default Print Options](#)
 - [Economode](#)
3. Select [On](#) or [Off](#) to enable or disable the feature.

Set the sleep timer and configure the printer to use 1 watt or less of power

The sleep settings affect how much power the printer uses, the wake/sleep time, how quickly the printer enters sleep mode, and how quickly the printer wakes up from sleep mode.

To configure the printer to use 1 watt or less of power while in sleep mode, enter times for both the Sleep after Inactivity and Auto Off after sleep settings.

1. From the Home screen on the printer control panel, open the [Settings](#) menu.
2. Open the following menus:

- [General Settings](#)
 - [Energy Settings](#)
 - [Sleep Settings](#)
3. Select [Sleep after Inactivity](#) to specify the number of minutes the printer is inactive before it enters sleep mode. Enter the appropriate time period.

 **NOTE:** The sleep-mode default time is 0 minutes. Zero (0) indicates that the printer will go to sleep in less than 1 minute.

4. Select [Auto Off after sleep](#) to put the printer into a deeper power save mode after a period of sleep. Enter the appropriate time period.

 **NOTE:** By default, the printer will wake from Auto Off in response to any activity other than USB or Wi-Fi, but can be set to wake only to the power button.

5. Select [Done](#) to save the settings.

Set the sleep schedule

Use the [Sleep Schedule](#) feature to configure the printer to automatically wake or go into Sleep mode at specific times on specific days of the week.

1. From the Home screen on the printer control panel, open the [Settings](#) menu.
2. Open the following menus:
 - [General Settings](#)
 - [Energy Settings](#)
 - [Sleep Schedule](#)
3. Select the [New Event](#) button, and then select the type of event to schedule: [Wake Event](#) or [Sleep Event](#).
4. For a wake or sleep event, configure the time and the days of the week for the event. Select [Save](#) to save the setting.

HP Web Jetadmin

HP Web Jetadmin is an award-winning, industry-leading tool for efficiently managing a wide variety of networked HP products, including printers, multifunction printers, and digital senders. This single solution allows you to remotely install, monitor, maintain, troubleshoot, and secure your printing and imaging environment — ultimately increasing business productivity by helping you save time, control costs, and protect your investment.

HP Web Jetadmin upgrades are periodically made available to provide support for specific product features. Go to www.hp.com/go/webjetadmin for more information.

Software and firmware updates

HP regularly updates features that are available in the printer firmware. To take advantage of the most current features, update the printer firmware. Download the most recent firmware update file from the Web:

Go to www.hp.com/support/ljM631MFP, www.hp.com/support/ljM632MFP, or www.hp.com/support/ljM633MFP. Click **Drivers & Software**.

9 Solve problems

- [Customer support](#)
- [Control panel help system](#)
- [Restore factory settings](#)
- [A “Cartridge is low” or “Cartridge is very low” message displays on the printer control panel](#)
- [Printer does not pick up paper or misfeeds](#)
- [Clear paper jams](#)
- [Improve print quality](#)
- [Image defects table](#)
- [Improve copy image quality](#)
- [Improve scan image quality](#)
- [Improve fax image quality](#)
- [Solve wired network problems](#)
- [Solve wireless network problems](#)
- [Solve fax problems](#)

For more information:

The following information is correct at the time of publication. For current information, see www.hp.com/support/ljM631MFP, www.hp.com/support/ljM632MFP, or www.hp.com/support/ljM633MFP.

HP's all-inclusive help for the printer includes the following information:

- Install and configure
- Learn and use
- Solve problems
- Download software and firmware updates
- Join support forums
- Find warranty and regulatory information

Customer support

Get telephone support for your country/region	Country/region phone numbers are on the flyer that was in the box with the printer or at support.hp.com .
Have the printer name, serial number, date of purchase, and problem description ready	
Get 24-hour Internet support, and download software utilities and drivers	www.hp.com/support/ljM631MFP , www.hp.com/support/ljM632MFP , or www.hp.com/support/ljM633MFP
Order additional HP service or maintenance agreements	www.hp.com/go/carepack
Register the printer	www.register.hp.com

Control panel help system

The printer has a built-in Help system that explains how to use each screen. To open the Help system, touch the Help  button in the upper-right corner of the screen.



For some screens, the Help opens to a global menu where you can search for specific topics. You can browse through the menu structure by touching the buttons in the menu.

Some Help screens include animations that show specific procedures, such as clearing paper jams.

If the printer alerts of an error or warning, touch the Help  button to open a message that describes the problem. The message also contains instructions to help solve the problem.

Restore factory settings

Introduction

Use one of the following methods to restore the printer to the original settings from the factory.

 **NOTE:** Restoring factory settings sets most of the printer settings to their factory defaults. However, some settings are not changed, such as language, date, time, and some network configuration settings.

Method one: Restore factory settings from the printer control panel



1. From the Home screen on the printer control panel, swipe until the **Settings** menu displays. Touch the **Settings** icon to open the menu.
2. Open the following menus:
 - **General**
 - **Reset Factory Settings**
3. Touch **Reset**.

A verification message advises that completing the reset function might result in loss of data.

4. Select **Reset** to complete the process.

 **NOTE:** The printer restarts automatically after the reset operation completes.

Method two: Restore factory settings from the HP Embedded Web Server (network-connected printers only)

1. Open the HP Embedded Web Server (EWS):
 - a. From the Home screen on the printer control panel, touch the Information  icon, and then touch the Network  icon to display the IP address or host name.
 - b. Open a web browser, and in the address line, type the IP address or host name exactly as it displays on the printer control panel. Press the **Enter** key on the computer keyboard. The EWS opens.

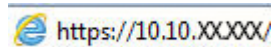

 **NOTE:** If the web browser displays a message indicating that accessing the website might not be safe, select the option to continue to the website. Accessing this website will not harm the computer.

2. Open the **General** tab.
3. On the left side of the screen, click **Reset Factory Settings**.
4. Click the **Reset** button.

 **NOTE:** The printer restarts automatically after the reset operation completes.

A “Cartridge is low” or “Cartridge is very low” message displays on the printer control panel

Cartridge is low: The printer indicates when a toner cartridge level is low. Actual toner cartridge life remaining may vary. Consider having a replacement available to install when print quality is no longer acceptable. The toner cartridge does not need to be replaced now.

Continue printing with the current cartridge until redistributing the toner no longer yields acceptable print quality. To redistribute the toner, remove the toner cartridge from the printer and gently rock the cartridge back and forth about its horizontal axis. For graphical representation, see cartridge replacement instructions. Reinsert the toner cartridge into the printer and close the cover.

Cartridge is very low: The printer indicates when the toner cartridge level is very low. Actual toner cartridge life remaining may vary. Consider having a replacement available to install when print quality is no longer acceptable. The toner cartridge does not need to be replaced now unless the print quality is no longer acceptable.

Once an HP toner cartridge has reached **Very Low**, HP's Premium Protection Warranty on that toner cartridge has ended.

Change the “Very Low” settings

You can change the way the printer reacts when supplies reach the Very Low state. You do not have to re-establish these settings when you install a new toner cartridge.

1. From the Home screen on the printer control panel, scroll to and select [Settings](#).
2. Open the following menus:
 - [Manage Supplies](#)
 - [Very Low Behavior](#)
 - [Black Cartridge](#) or [Color Cartridges](#)
3. Select one of the following options:
 - Select the [Stop](#) option to set the printer to stop printing when the cartridge reaches the **Very Low** threshold.
 - Select the [Prompt to continue](#) option to set the printer to stop printing when the cartridge reaches the **Very Low** threshold. You can acknowledge the prompt or replace the cartridge to resume printing.
 - Select the [Continue](#) option to set the printer to alert you that the cartridge is very low, and to continue printing beyond the **Very Low** setting without interaction. This can result in unsatisfactory print quality.

For printers with fax capability

When the printer is set to the [Stop](#) or [Prompt to continue](#) option, there is some risk that faxes will not print when the printer resumes printing. This can occur if the printer has received more faxes than the memory can hold while the printer is waiting.

The printer can print faxes without interruption when it passes the Very Low threshold if you select the [Continue](#) option for the toner cartridge, but print quality might degrade.

Order supplies

Order supplies and paper	www.hp.com/go/suresupply
Order through service or support providers	Contact an HP-authorized service or support provider.
Order using the HP Embedded Web Server (EWS)	To access, in a supported web browser on your computer, enter the printer IP address or host name in the address/URL field. The EWS contains a link to the HP SureSupply web site, which provides options for purchasing Original HP supplies.

Printer does not pick up paper or misfeeds

Introduction

The following solutions can help solve problems if the printer is not picking up paper from the tray or is picking up multiple sheets of paper at one time. Either of these situations can result in paper jams.

- [The printer does not pick up paper](#)
- [The printer picks up multiple sheets of paper](#)
- [The document feeder jams, skews, or picks up multiple sheets of paper](#)

The printer does not pick up paper

If the printer does not pick up paper from the tray, try these solutions.

1. Open the printer and remove any jammed sheets of paper. Verify that no torn remnants of paper remain inside the printer.
2. Load the tray with the correct size of paper for the job.
3. Make sure the paper size and type are set correctly on the printer control panel.

4. Make sure the paper guides in the tray are adjusted correctly for the size of paper. Adjust the guides to the appropriate indentation in the tray. The arrow on the tray guide should line up exactly with the marking on the tray.

 **NOTE:** Do not adjust the paper guides tightly against the paper stack. Adjust them to the indentations or markings in the tray.

The following images show examples of the paper-size indentations in the trays for various printers. Most HP printers have markings similar to these.

Figure 9-1 Size markings for Tray 1 or the multipurpose tray

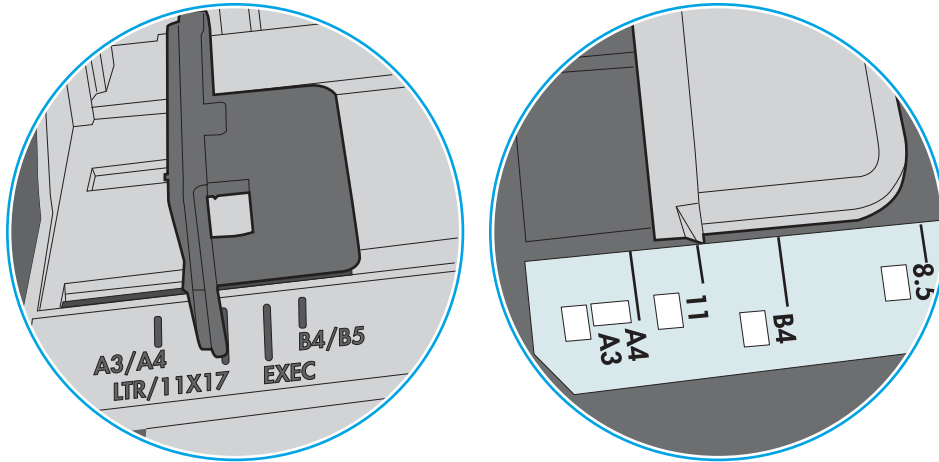
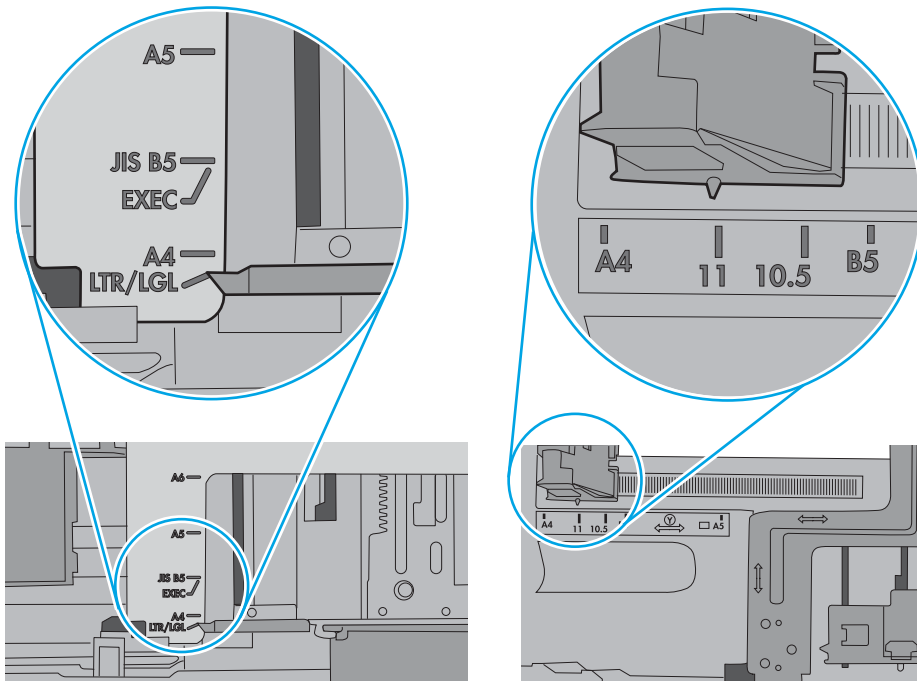

Figure 9-2 Size markings for cassette trays



5. Verify that the humidity in the room is within specifications for this printer and that paper is being stored in unopened packages. Most reams of paper are sold in moisture-proof wrapping to keep paper dry.

In high-humidity environments, paper at the top of the stack in the tray can absorb moisture, and it might have a wavy or uneven appearance. If this happens, remove the top 5 to 10 sheets of paper from the stack.

In low-humidity environments, excess static electricity can cause sheets of paper to stick together. If this happens, remove the paper from the tray, and flex the stack by holding it at each end and bringing the ends up to form a U shape. Then, rotate the ends down to reverse the U shape. Next, hold each side of the stack of paper, and repeat this process. This process releases individual sheets without introducing static electricity. Straighten the paper stack against a table before returning it to the tray.

Figure 9-3 Technique for flexing the paper stack

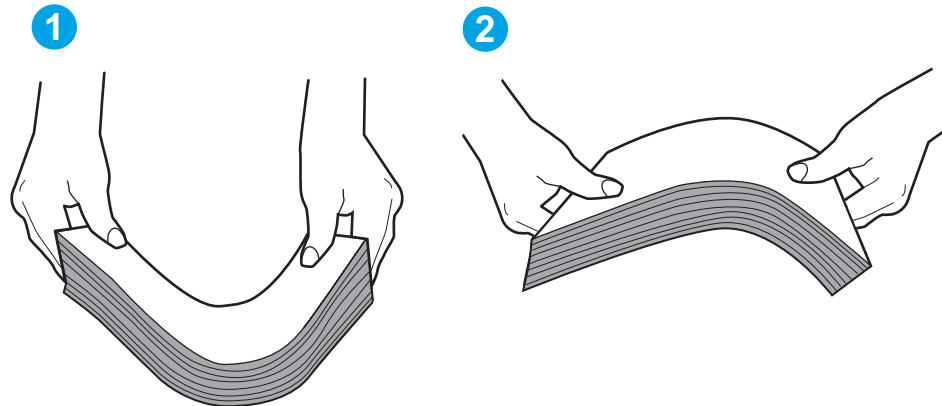

6. Check the printer control panel to see if it is displaying a prompt to feed the paper manually. Load paper, and continue.
7. The rollers above the tray might be contaminated. Clean the rollers with a lint-free cloth dampened with warm water. Use distilled water, if it is available.

CAUTION: Do not spray water directly on to the printer. Instead, spray water on the cloth or dab the cloth in water and wring it out before cleaning the rollers.

The following image shows examples of the roller location for various printers.

Figure 9-4 Roller locations for Tray 1 or the multipurpose tray

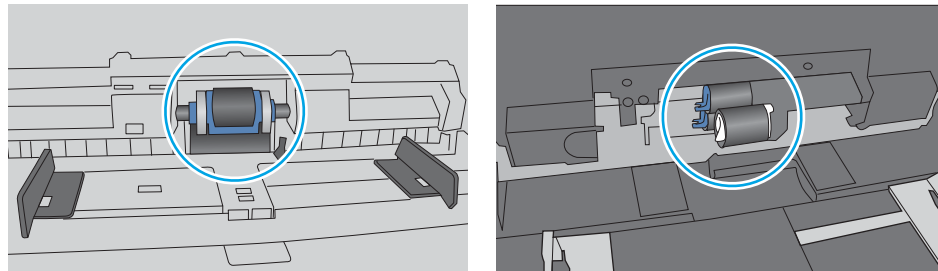

The printer picks up multiple sheets of paper

If the printer picks up multiple sheets of paper from the tray, try these solutions.

1. Remove the stack of paper from the tray and flex it, rotate it 180 degrees, and flip it over. *Do not fan the paper.* Return the stack of paper to the tray.

 **NOTE:** Fanning the paper introduces static electricity. Instead of fanning the paper, flex the stack by holding it at each end and bringing the ends up to form a U shape. Then, rotate the ends down to reverse the U shape. Next, hold each side of the stack of paper, and repeat this process. This process releases individual sheets without introducing static electricity. Straighten the paper stack against a table before returning it to the tray.

Figure 9-5 Technique for flexing the paper stack



2. Use only paper that meets HP specifications for this printer.
3. Verify that the humidity in the room is within specifications for this printer, and that paper is being stored in unopened packages. Most reams of paper are sold in moisture-proof wrapping to keep paper dry.

In high-humidity environments, paper at the top of the stack in the tray can absorb moisture, and it might have a wavy or uneven appearance. If this happens, remove the top 5 to 10 sheets of paper from the stack.

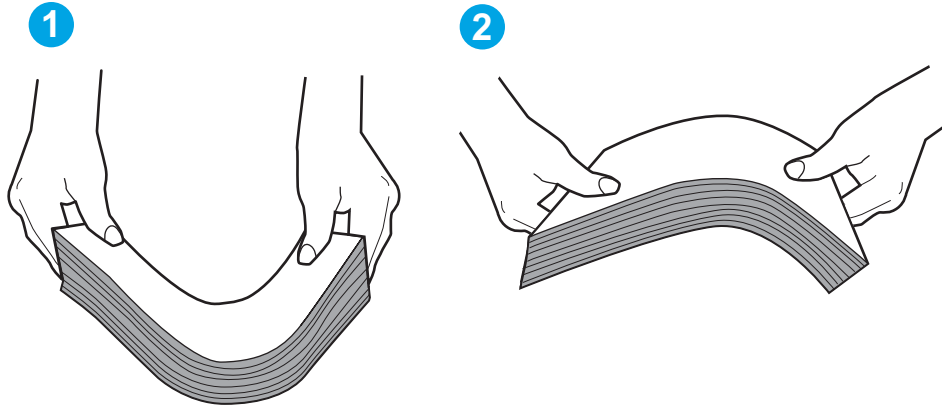
In low-humidity environments, excess static electricity can cause sheets of paper to stick together. If this happens, remove the paper from the tray, and flex the stack as described above.

4. Use paper that is not wrinkled, folded, or damaged. If necessary, use paper from a different package.

5. Make sure the tray is not overfilled by checking the stack-height markings inside the tray. If it is overfilled, remove the entire stack of paper from the tray, straighten the stack, and then return some of the paper to the tray.

The following images show examples of the stack-height markings in the trays for various printers. Most HP printers have markings similar to these. Also make sure that all sheets of paper are below the tabs near the stack-height marks. These tabs help hold the paper in the correct position as it enters the printer.

Figure 9-6 Stack-height markings

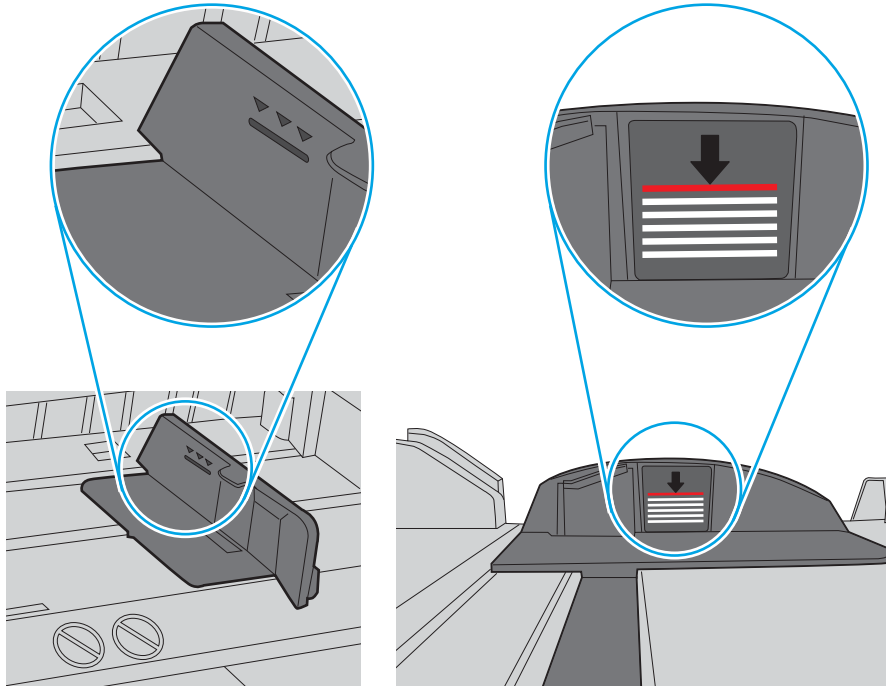
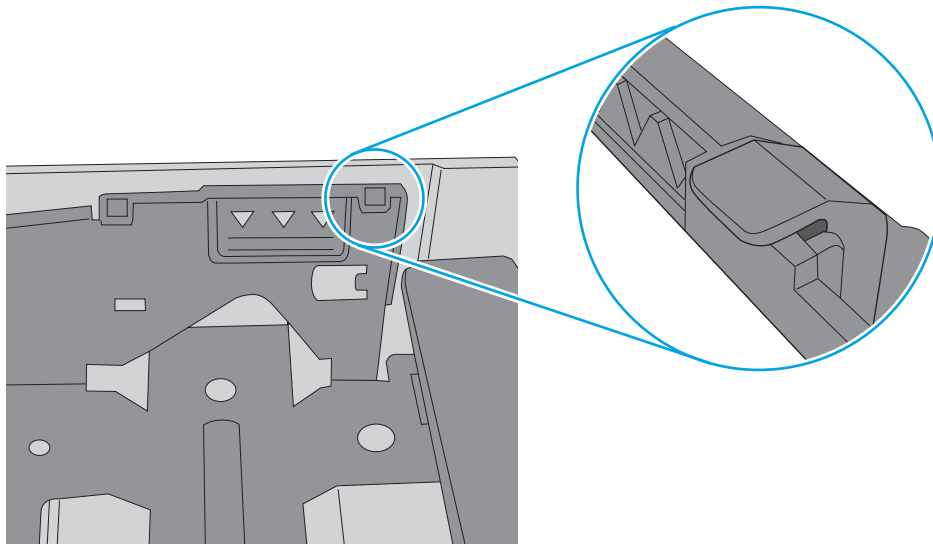

Figure 9-7 Tab for the paper stack



6. Make sure the paper guides in the tray are adjusted correctly for the size of paper. Adjust the guides to the appropriate indentation in the tray. The arrow on the tray guide should line up exactly with the marking on the tray.

 **NOTE:** Do not adjust the paper guides tightly against the paper stack. Adjust them to the indentations or markings in the tray.

The following images show examples of the paper-size indentations in the trays for various printers. Most HP printers have markings similar to these.

Figure 9-8 Size markings for Tray 1 or the multipurpose tray

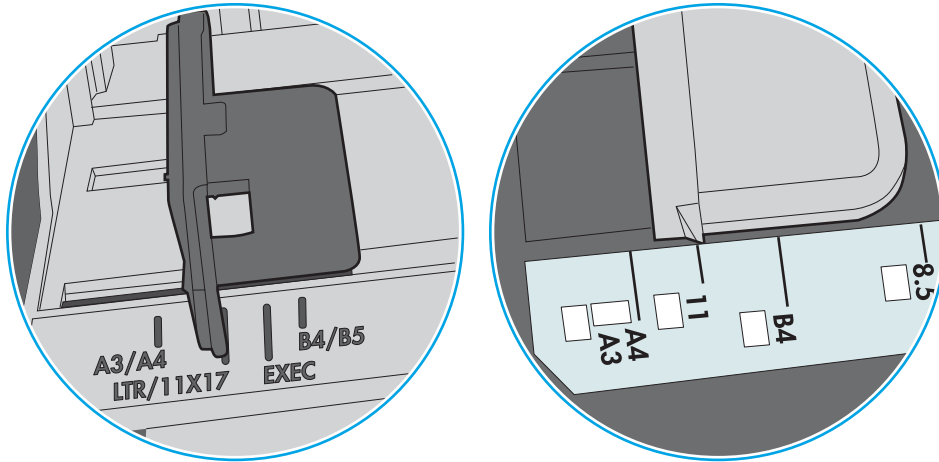
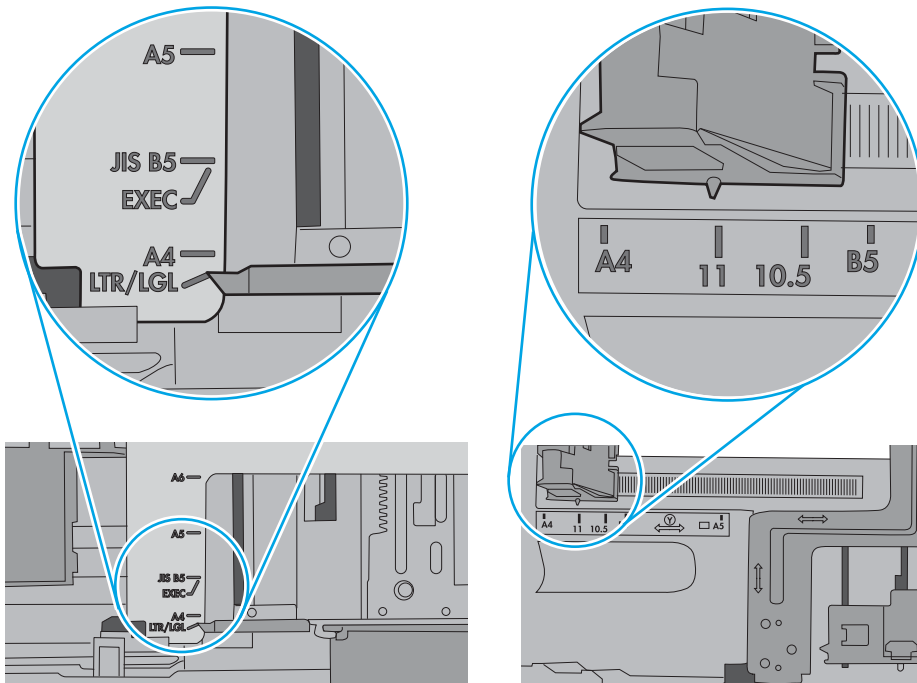

Figure 9-9 Size markings for cassette trays



7. Make sure the printing environment is within recommended specifications.

The document feeder jams, skews, or picks up multiple sheets of paper

 **NOTE:** This information applies to MFP printers only.

- The original might have something on it, such as staples or self-adhesive notes, that must be removed.
- Check that all rollers are in place and that the roller-access cover inside the document feeder is closed.
- Make sure that the top document-feeder cover is closed.
- The pages might not be placed correctly. Straighten the pages and adjust the paper guides to center the stack.
- The paper guides must be touching the sides of the paper stack to work correctly. Make sure that the paper stack is straight and the guides are against the paper stack.
- The document feeder input tray or output bin might contain more than the maximum number of pages. Make sure the paper stack fits below the guides in the input tray, and remove pages from the output bin.
- Verify that there are no pieces of paper, staples, paper clips, or other debris in the paper path.
- Clean the document-feeder rollers and the separation pad. Use compressed air or a clean, lint-free cloth moistened with warm water. If misfeeds still occur, replace the rollers.
- From the Home screen on the printer control panel, scroll to and touch the [Supplies](#) button. Check the status of the document-feeder kit, and replace it if necessary.

Clear paper jams

Introduction

The following information includes instructions for clearing paper jams from the printer.

- [Paper jam locations](#)
- [Auto-navigation for clearing paper jams](#)
- [Experiencing frequent or recurring paper jams?](#)
- [Clear paper jams in the document feeder](#)
- [Clear paper jams in Tray 1](#)
- [Clear paper jams in Trays 2, 3, 4, or 5](#)
- [Clear paper jams in the 2,100-sheet high-capacity input tray](#)
- [Clear paper jams in the right door and fuser area](#)
- [Clear paper jams in the output bin](#)
- [Clear paper jams in the duplexer](#)
- [Clear paper jams in the envelope feeder](#)
- [Clear paper jams in the HP Stapling Mailbox](#)
- [Clear staple jams](#)

Paper jam locations

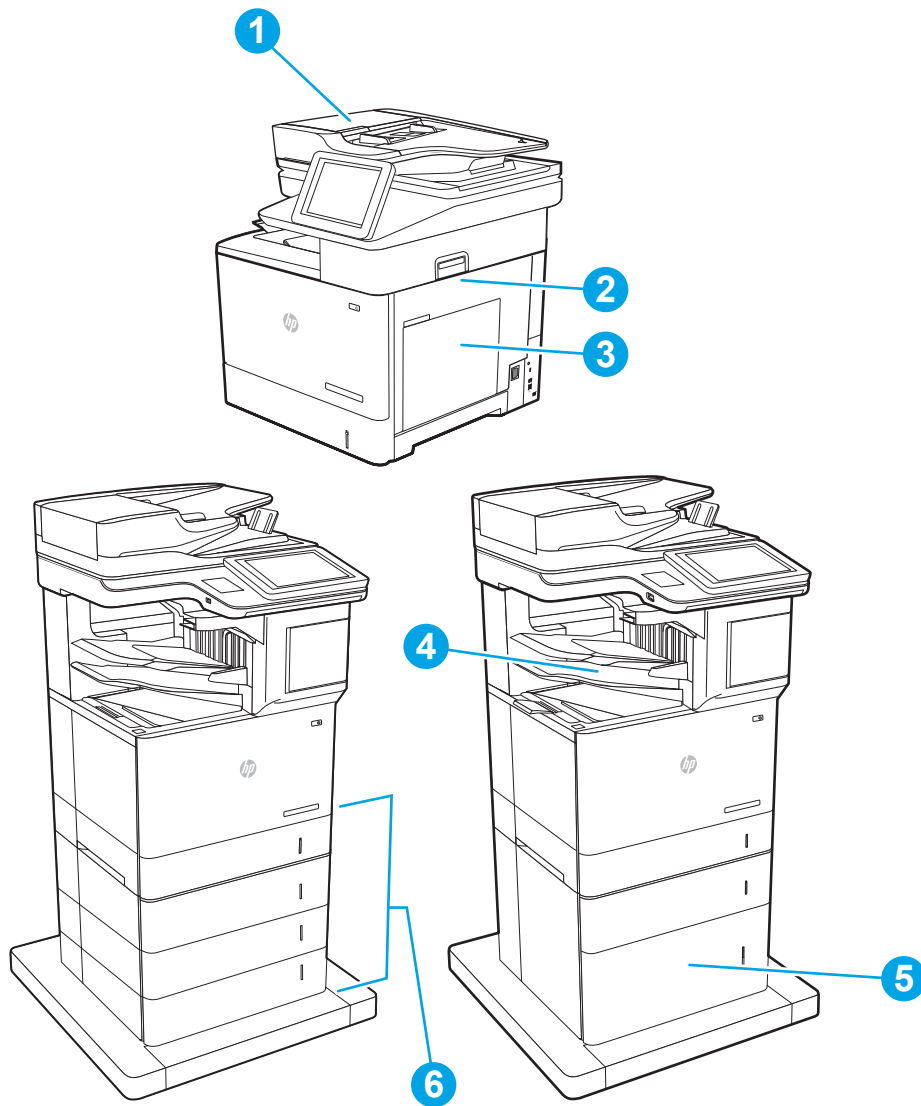

1	Document feeder
2	Duplexer and fuser
3	Tray 1
4	Output bin, HP Stapling Mailbox
5	2,100-sheet HCI feeder
6	Trays 2-5 Envelope feeder (not shown)

Auto-navigation for clearing paper jams

The auto-navigation feature assists in clearing jams by providing step-by-step instructions on the control panel. When you complete a step, the printer displays instructions for the next step until you have completed all steps in the procedure.

Experiencing frequent or recurring paper jams?

To reduce the number of paper jams, try these solutions.



NOTE: To see a video that demonstrates how to load paper in a way that reduces the number of paper jams, click [here](#).

1. Use only paper that meets HP specifications for this printer.
2. Use paper that is not wrinkled, folded, or damaged. If necessary, use paper from a different package.
3. Use paper that has not previously been printed or copied on.
4. Make sure the tray is not overfilled. If it is, remove the entire stack of paper from the tray, straighten the stack, and then return some of the paper to the tray.
5. Make sure the paper guides in the tray are adjusted correctly for the size of paper. Adjust the guides so they are touching the paper stack without bending it.
6. Make sure that the tray is fully inserted in the printer.
7. If you are printing on heavy, embossed, or perforated paper, use the manual feed feature and feed sheets one at a time.
8. Open the **Trays** menu on the printer control panel. Verify that the tray is configured correctly for the paper type and size.
9. Make sure the printing environment is within recommended specifications.

Clear paper jams in the document feeder

The following information describes how to clear paper jams in the document feeder. When a jam occurs, the control panel displays the following message and an animation that assists in clearing the jam.

- **31.13.XX Jam in Document Feeder**

1. Lift the latch to release the document-feeder cover.

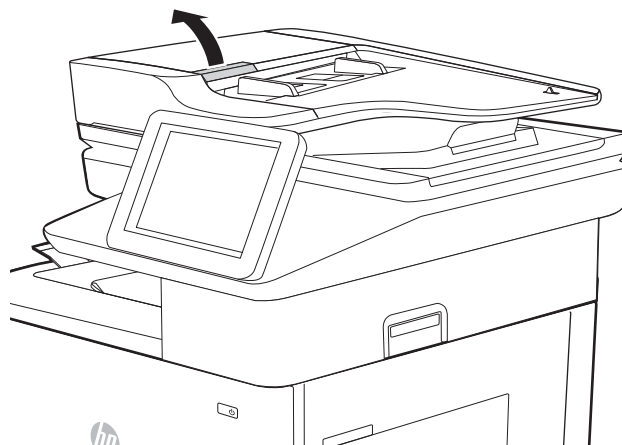

2. Open the document-feeder cover.

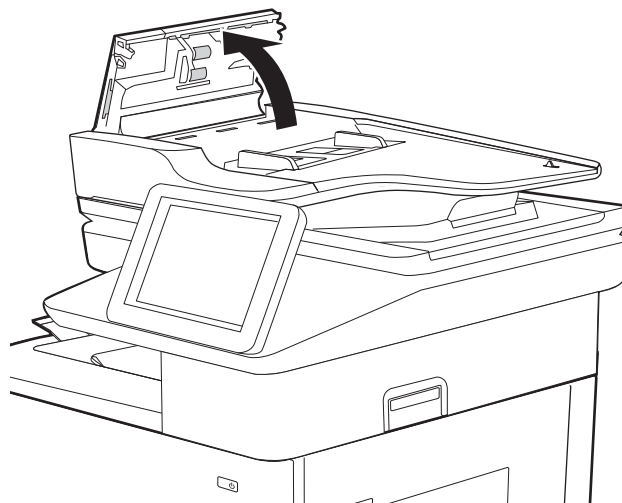

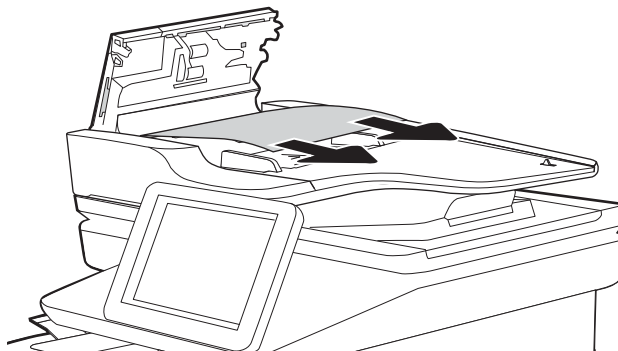

3. Remove any jammed paper.

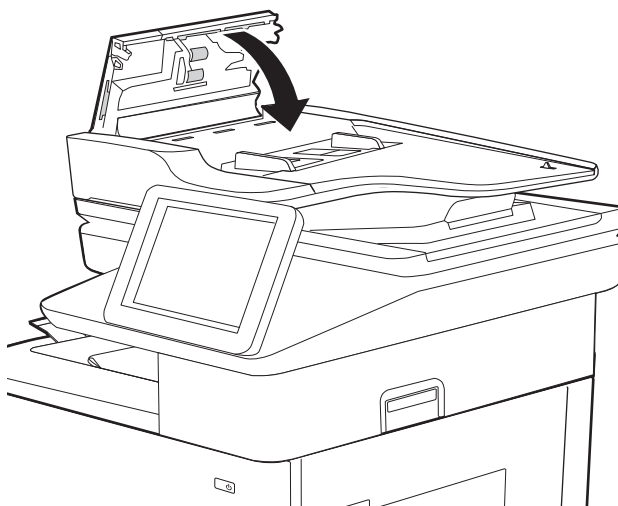

4. Close the document-feeder cover.



 **NOTE:** To avoid jams, make sure the guides in the document-feeder input tray are adjusted tightly against the document. Remove all staples and paper clips from original documents.

 **NOTE:** Original documents that are printed on heavy, glossy paper can jam more frequently than originals that are printed on plain paper.

Clear paper jams in Tray 1

The following information describes how to clear a paper jam in Tray 1. When a jam occurs, the control panel displays the following message and an animation that assists in clearing the jam.

- **13.A1.XX Jam in Tray 1**

1. If jammed paper is visible in Tray 1, clear the jam by gently pulling the paper straight out.

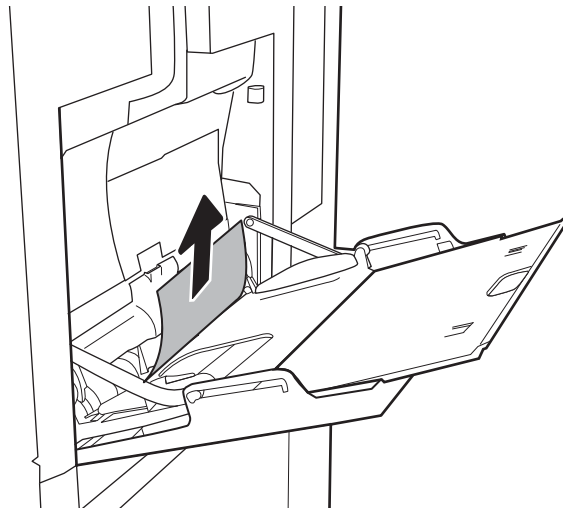

2. If you cannot remove the paper, or if no jammed paper is visible in Tray 1, close Tray 1 and open the right door.

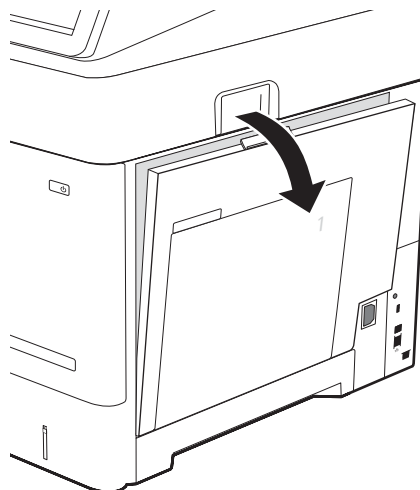

3. Gently pull out any jammed paper.

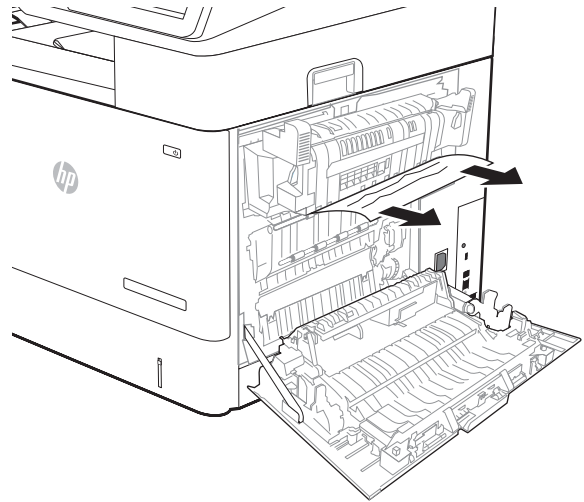

4. Close the right door.

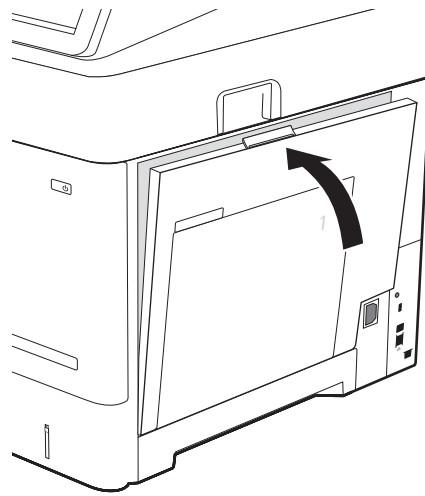

Clear paper jams in Trays 2, 3, 4, or 5

The following information describes how to clear a paper jam in Trays 2, 3, 4, or 5. When a jam occurs, the control panel displays one of the following messages and an animation that assists in clearing the jam.

- 13.A2.XX Jam in Tray 2
- 13.A3.XX Jam in Tray 3
- 13.A4.XX Jam in Tray 4
- 13.A5.XX Jam in Tray 5

 **NOTE:** The following procedure shows Tray 2. The method to clear jams in Trays 3, 4, and 5 is the same.

1. Pull the tray completely out of the printer by pulling and lifting it up slightly.

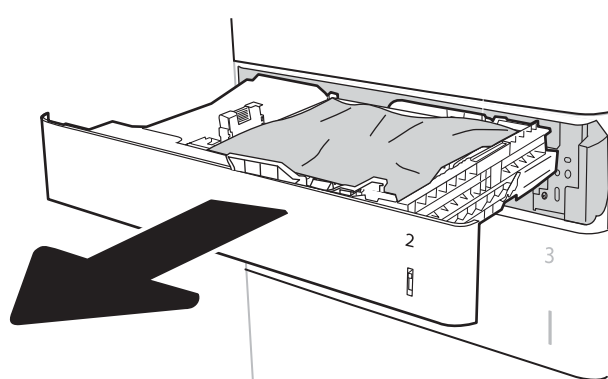

2. Remove any jammed or damaged sheets of paper from the tray.

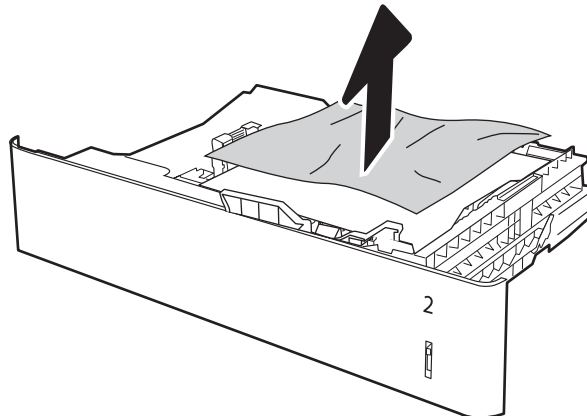

3. Remove any paper from the feed rollers inside the printer.

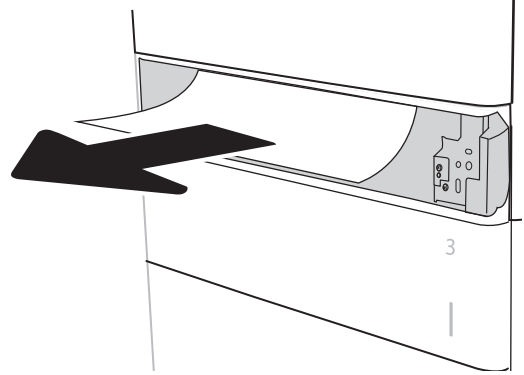

4. Reinsert and close the tray.

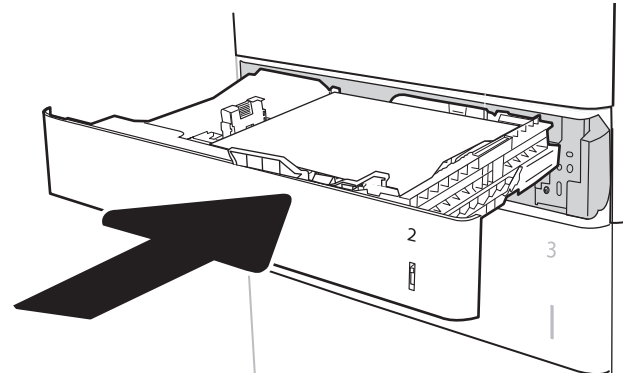

5. Open the right door.

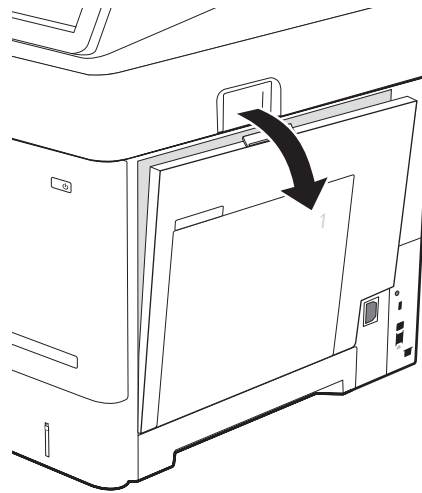

6. Remove any jammed paper.

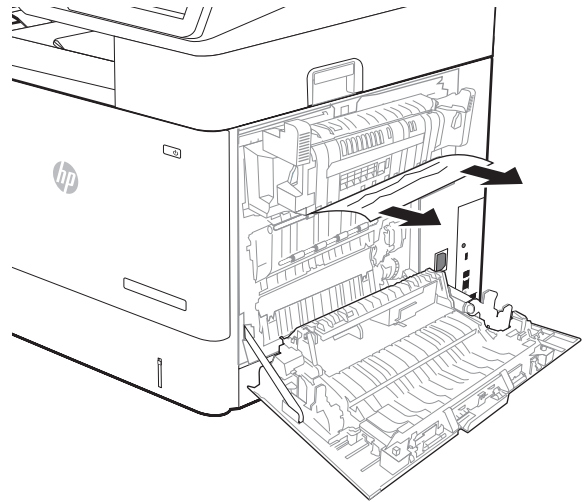

7. Remove the fuser by grabbing the two side latches and pulling the fuser straight out of the printer.



CAUTION: The fuser can be hot while the printer is in use. Wait for the fuser to cool before handling it.

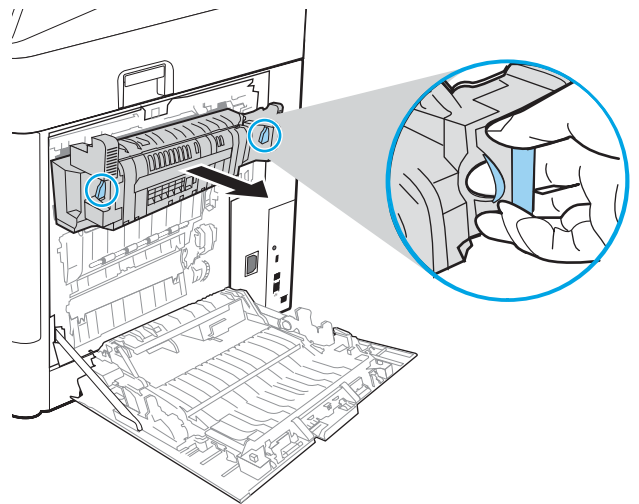

8. Remove any jammed paper from the fuser opening.

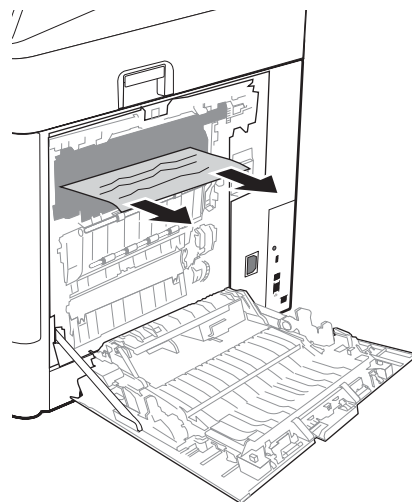

9. Reinstall the fuser.

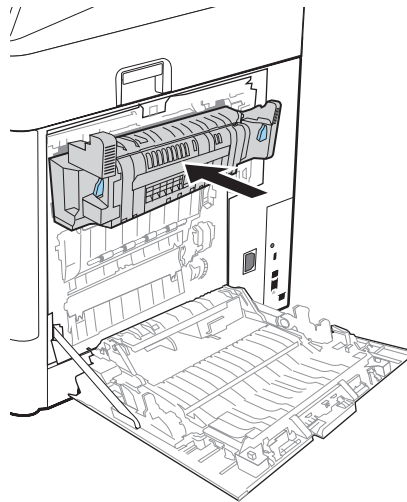

10. Close the right door.

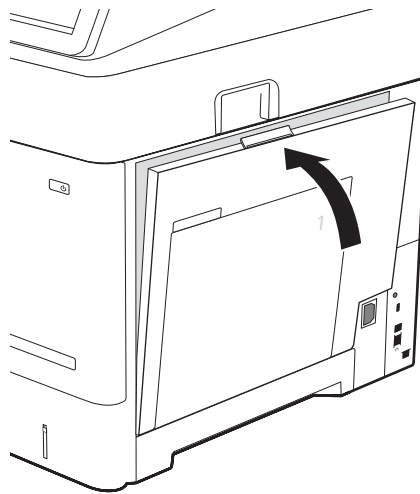

Clear paper jams in the 2,100-sheet high-capacity input tray

The following information describes how to clear a paper jam in the 2,100-sheet high-capacity tray. When a jam occurs, the control panel displays one of the following messages and an animation that assists in clearing the jam.

- **13.AY.XX Jam in Tray Y**, where Y equals the tray number assigned to the HCI
- **13.FFEE Door Open Jam**

1. Open the 2,100-sheet high-capacity input tray.

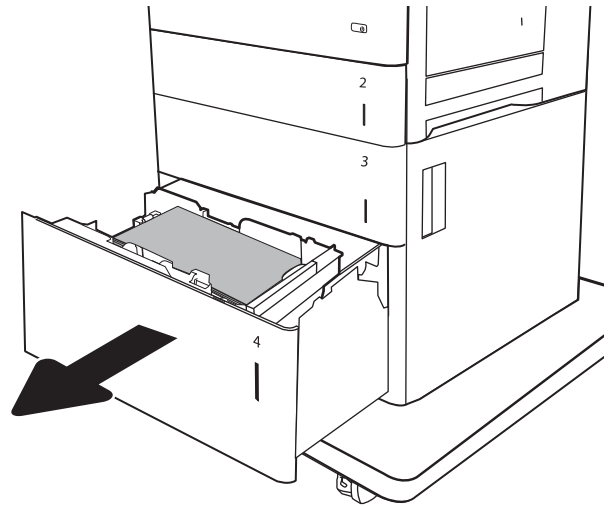

2. Remove and discard any damaged sheets.

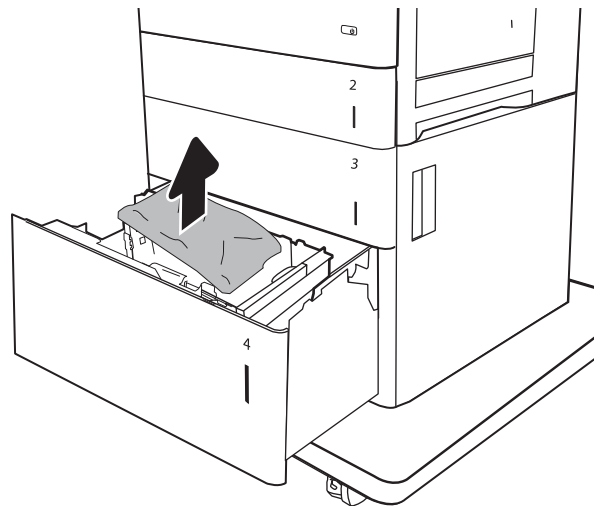

3. Remove the paper from the tray.

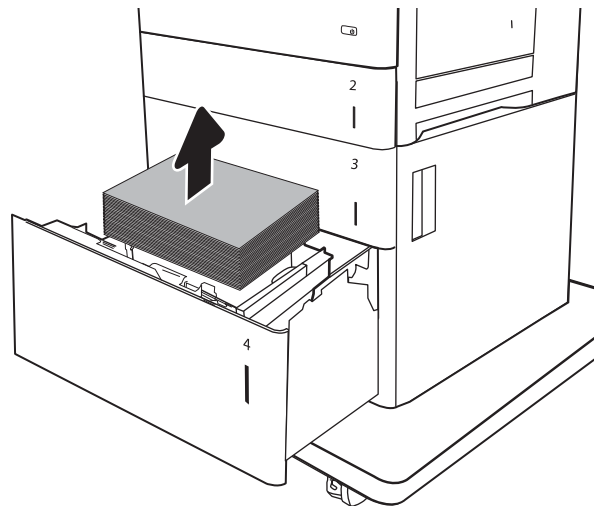

4. Lift the tray up and then pull it straight out to remove it.

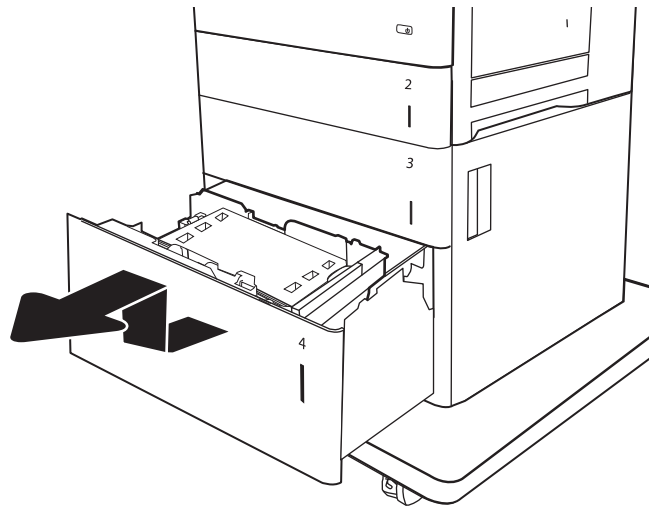

5. If jammed paper is in the feed area, pull it down to remove it.

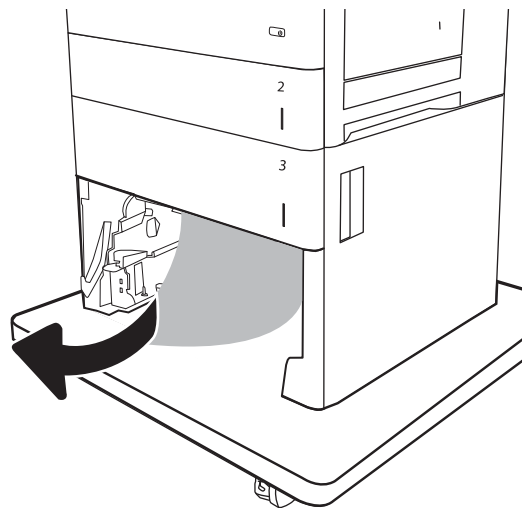

6. Reinstall the tray, and then load full reams of paper into the tray. The tray holds 2,100 sheets of paper.

NOTE: For best results, load full reams of paper. Avoid dividing reams into smaller sections.

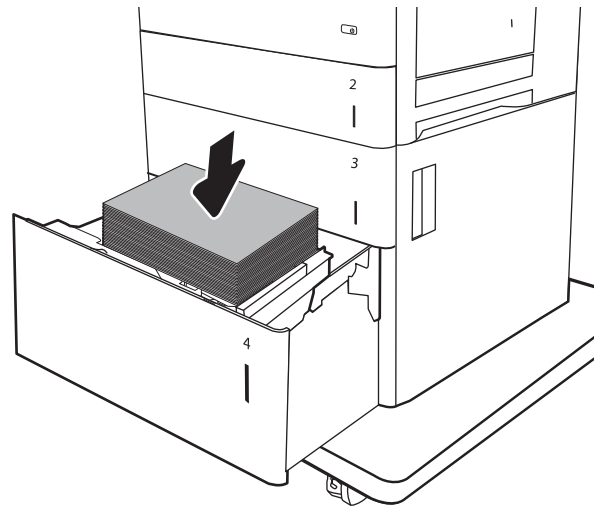

7. Close the tray.

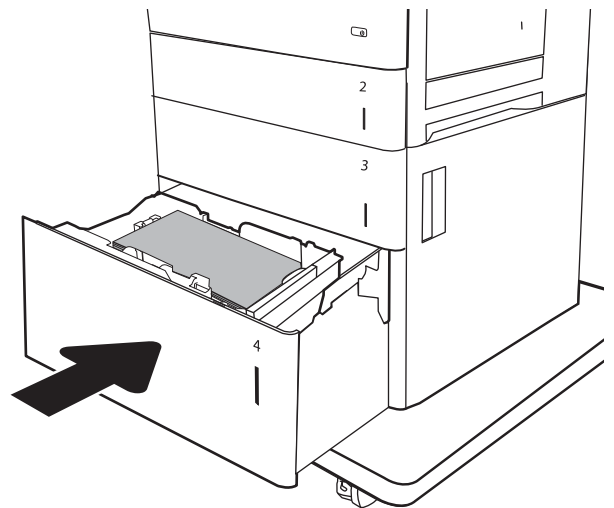

Clear paper jams in the right door and fuser area

Use the following procedure to clear paper jams in the right door, duplexer, and fuser area. When a jam occurs, the control panel displays one of the following messages and an animation that assists in clearing the jam.

- 13.B2.XX Jam in <cover or door>
- 13.B9.XX Jam in Fuser
- 13.FFEE Door Open Jam

⚠ CAUTION: The fuser is hot while the printer is in use. Wait for the fuser to cool before clearing jams.

1. Open the right door.

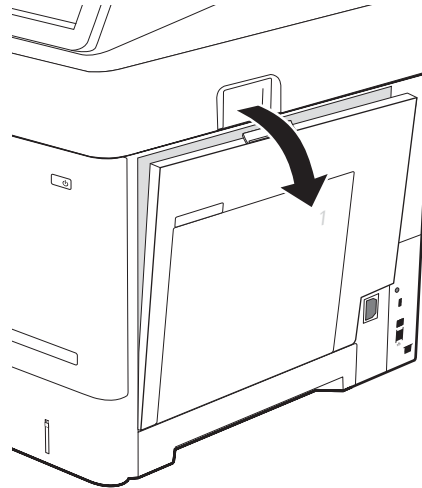

2. Remove any jammed paper.

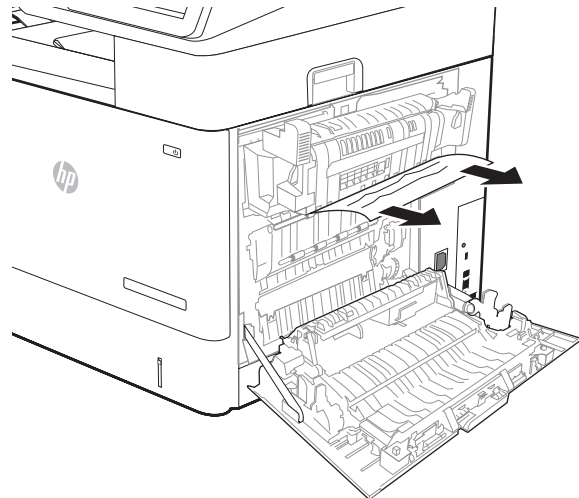

3. Remove the fuser by grabbing the two side latches and pulling the fuser straight out of the printer.



CAUTION: The fuser can be hot while the printer is in use. Wait for the fuser to cool before handling it.

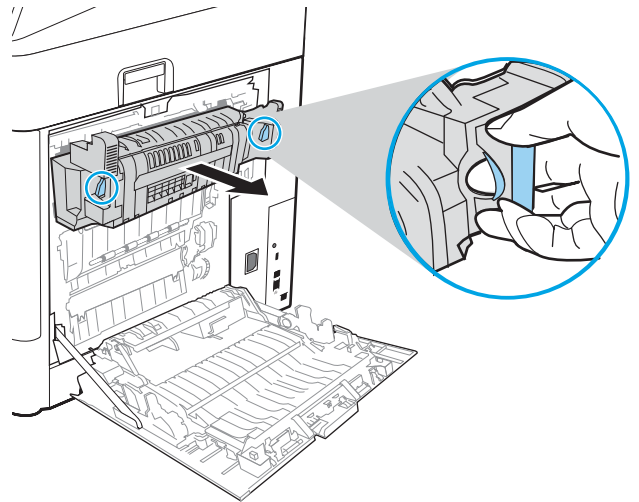

4. Remove any jammed paper from the fuser opening.

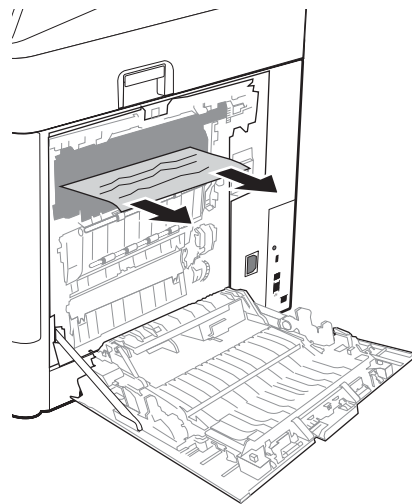

5. Reinstall the fuser.

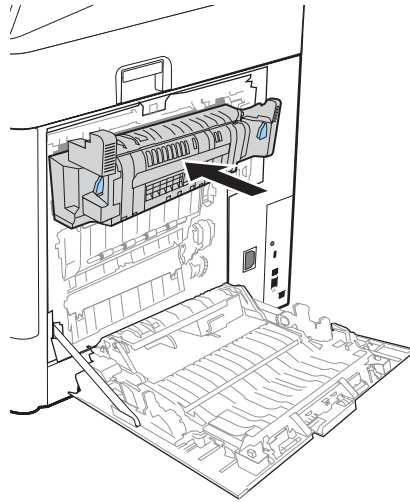

6. Close the right door.

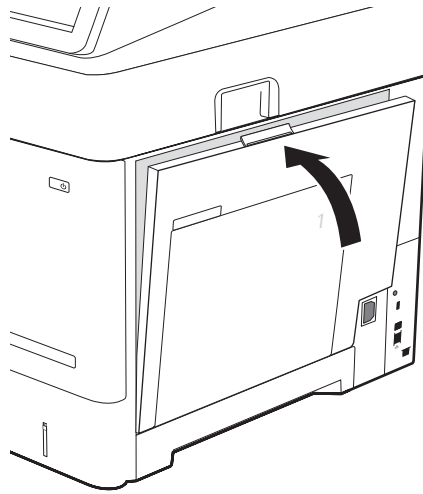

Clear paper jams in the output bin

The following information describes how to clear a paper jam in the output bin. When a jam occurs, the control panel displays the following message and an animation that assists in clearing the jam.

- **13.E1.XX Jam at Standard Output Bin**

1. If paper is visible in the output bin, grasp the leading edge and remove it.

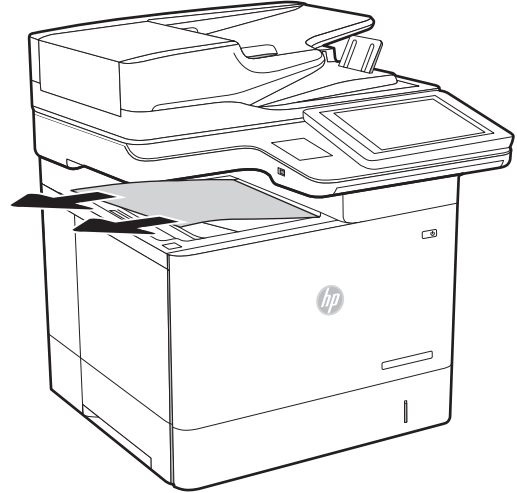

Clear paper jams in the duplexer

Use the following procedure to check for paper in all possible jam locations in the automatic duplexer. When a jam occurs, the control panel displays one of the following error messages and an animation that assists in clearing the jam.

- **13.B2.XX Jam in <cover or door>**
- **13.CX.XX Jam in Duplexer**
- **13.DX.XX Jam in Duplexer**

1. Open the right door.

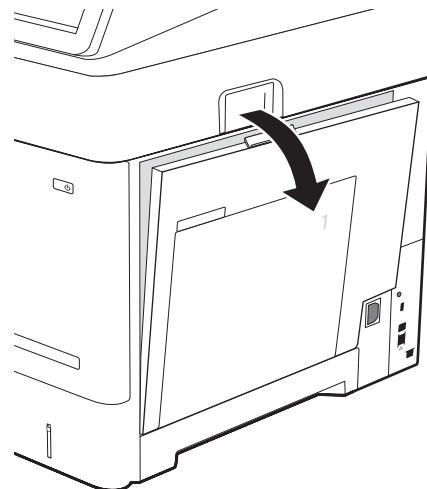

2. Remove any jammed paper.

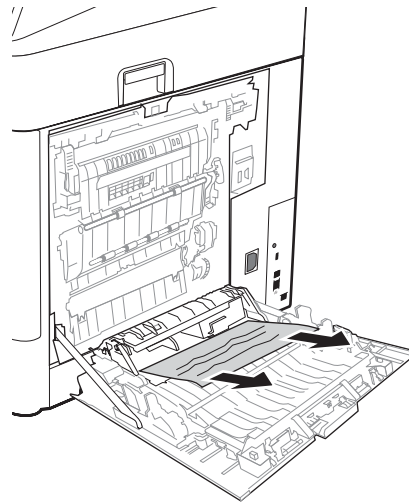

3. Close the right door

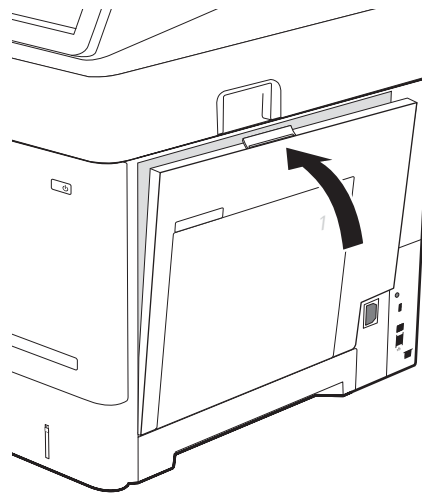

Clear paper jams in the envelope feeder

Use the following procedure to clear jams in the envelope feeder. When a jam occurs, the control panel displays one of the following messages and an animation that assists in clearing the jam.

- 13.A3.XX Jam in Tray 3
- 13.A4.XX Jam in Tray 4

1. Pull the tray completely out of the printer by pulling and lifting it up slightly.

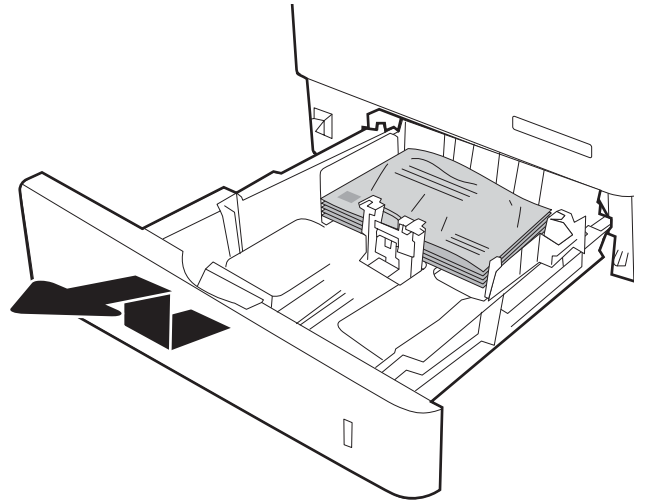

2. Remove any jammed or damaged envelopes from the tray.

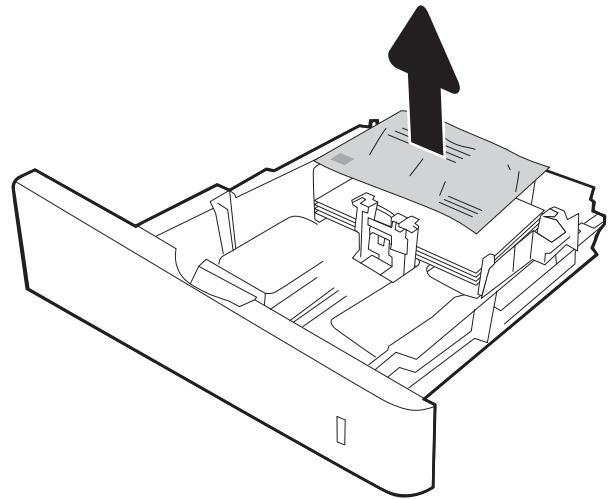

3. Remove any envelopes from the feed rollers inside the printer.

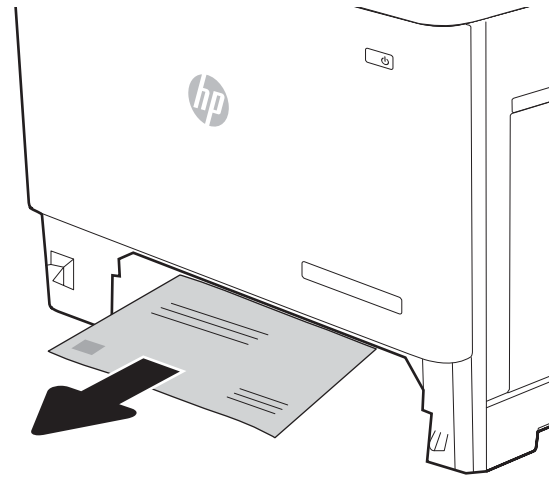

4. Reinsert and close the tray.

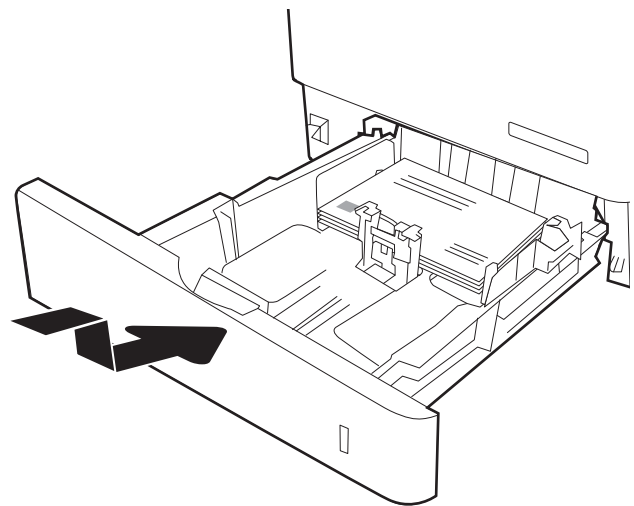

Clear paper jams in the HP Stapling Mailbox

The following information describes how to clear a paper jam in the HP Stapling Mailbox. When a jam occurs, the control panel displays one of the following error messages and an animation that assists in clearing the jam.

- 13.E1.XX Jam at Standard Output Bin
- 13.70.XX MBM Jam
- 13.8X Stapler/Stacker Jam

1. Remove any jammed paper from the HP Stapling Mailbox bins.

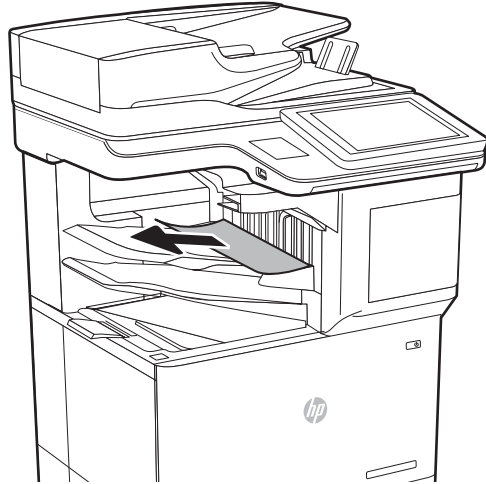

2. Open the jam-access door on the back side of the HP Stapling Mailbox. If jammed paper is visible inside the jam-access door, pull it straight out to remove it.

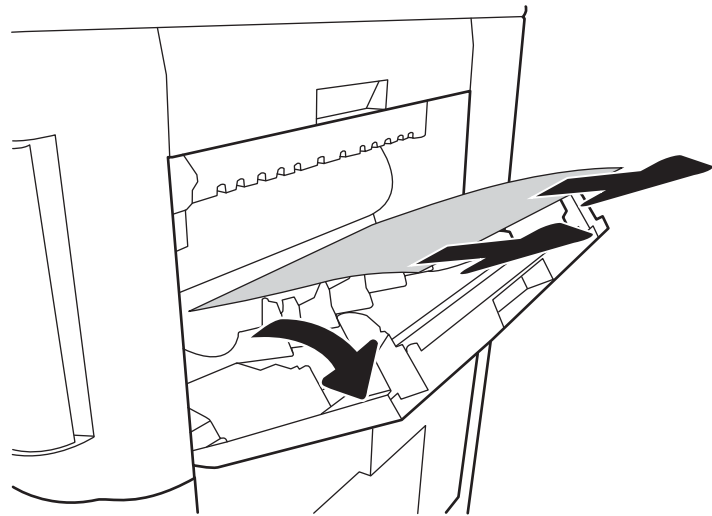

3. Close the HP Stapling Mailbox jam access door.

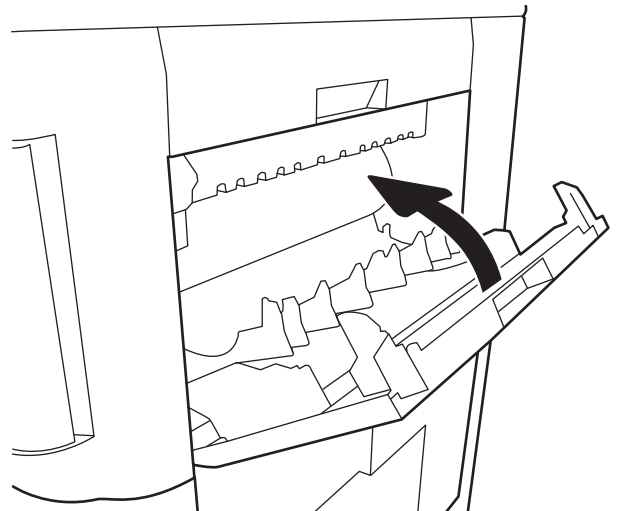

Clear staple jams

The following information describes how to clear a staple jam in the HP Stapling Mailbox. When a jam occurs, the control panel displays an animation that assists in clearing the jam.

- **13.8X.XX – Stapler/Stacker Jam**

1. Open the stapler door.

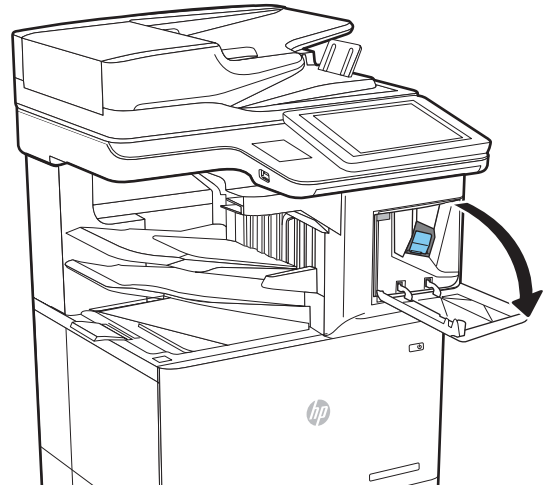

2. Pull the colored handle on the staple cartridge, and then pull the staple cartridge straight out.

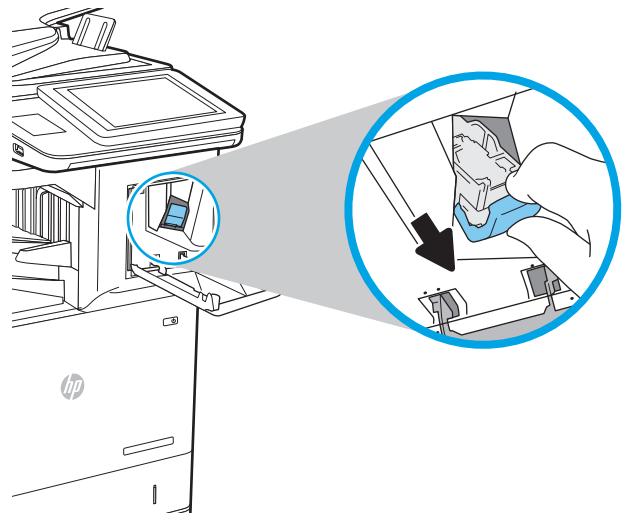

3. Lift up on the small lever at the back of the staple cartridge.

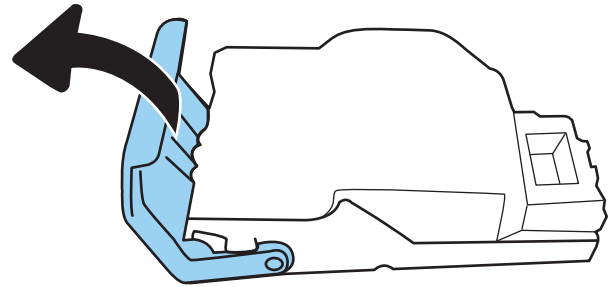

4. Remove the jammed staples.
5. Close the lever at the back of the staple cartridge. Be sure that it snaps into place.

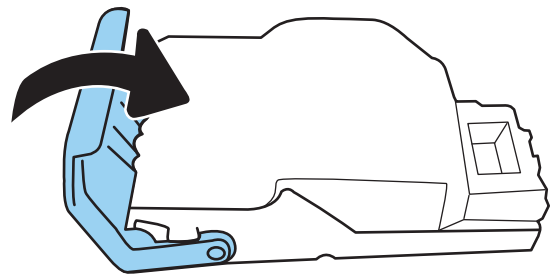

6. Insert the staple cartridge into the stapler and push on the colored handle until it snaps into place.

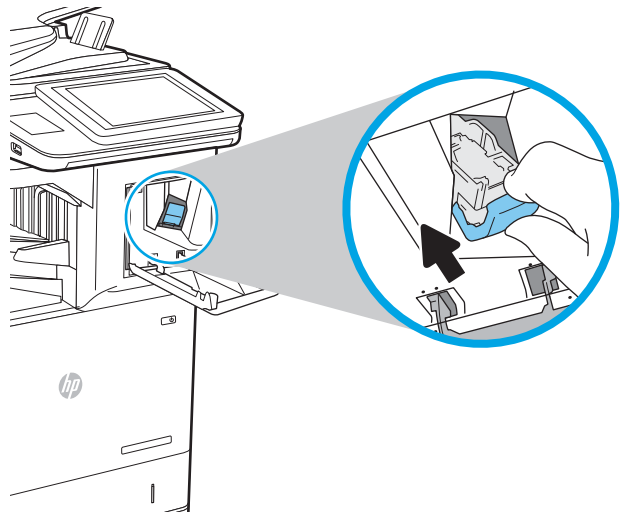

7. Close the stapler door.

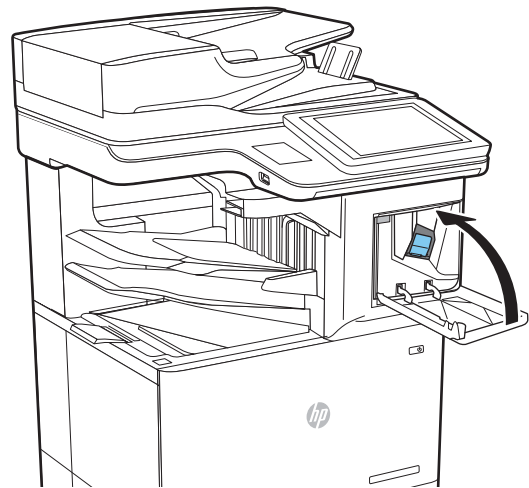

Improve print quality

Introduction

- [Print from a different software program](#)
- [Check the paper-type setting for the print job](#)
- [Check toner-cartridge status](#)
- [Print a cleaning page](#)
- [Visually inspect the toner cartridge](#)
- [Check paper and the printing environment](#)
- [Try a different print driver](#)
- [Check the EconoMode settings](#)
- [Adjust print density](#)

If the printer is having print-quality problems, try the following solutions in the order presented to resolve the issue.

Print from a different software program

Try printing from a different software program. If the page prints correctly, the problem is with the software program from which you were printing.

Check the paper-type setting for the print job

Check the paper type setting when printing from a software program and the printed pages have smears, fuzzy or dark print, curled paper, scattered dots of toner, loose toner, or small areas of missing toner.

Check the paper type setting (Windows)

1. From the software program, select the **Print** option.
2. Select the printer, and then click the **Properties** or **Preferences** button.
3. Click the **Paper/Quality** tab.
4. From the **Paper Type** drop-down list, click the **More...** option.
5. Expand the list of **Type is:** options.
6. Expand the category of paper types that best describes your paper.
7. Select the option for the type of paper you are using, and click the **OK** button.
8. Click the **OK** button to close the **Document Properties** dialog box. In the **Print** dialog box, click the **OK** button to print the job.

Check the paper type setting (OS X)

1. Click the **File** menu, and then click the **Print** option.
2. In the **Printer** menu, select the printer.
3. By default, the print driver displays the **Copies & Pages** menu. Open the menus drop-down list, and then click the **Finishing** menu.
4. Select a type from the **Media Type** drop-down list.
5. Click the **Print** button.

Check toner-cartridge status

Follow these steps to check the estimated life remaining in the toner cartridges and if applicable, the status of other replaceable maintenance parts.

Step one: Print the supplies status page

1. From the Home screen on the printer control panel, select the **Reports** menu.
2. Select the **Configuration/Status Pages** menu.
3. Select **Supplies Status Page**, and then select **Print** to print the page.

Step two: Check supplies status

1. Look at the supplies status report to check the percent of life remaining for the toner cartridges and, if applicable, the status of other replaceable maintenance parts.

Print quality problems can occur when using a toner cartridge that is at its estimated end of life. The supplies status page indicates when a supply level is very low. After an HP supply has reached the very low threshold, HP's premium protection warranty on that supply has ended.

The toner cartridge does not need to be replaced now unless the print quality is no longer acceptable. Consider having a replacement available to install when print quality is no longer acceptable.

If you determine that you need to replace a toner cartridge or other replaceable maintenance parts, the supplies status page lists the genuine HP part numbers.

2. Check to see if you are using a genuine HP cartridge.

A genuine HP toner cartridge has the word "HP" on it, or has the HP logo on it. For more information on identifying HP cartridges go to www.hp.com/go/learnaboutsupplies.

Print a cleaning page

During the printing process paper, toner, and dust particles can accumulate inside the printer and can cause print-quality issues such as toner specks or spatter, smears, streaks, lines, or repeating marks.

Follow these steps to clean the printer's paper path.

1. From the Home screen on the printer control panel, select the **Support Tools** menu.
2. Select the following menus:

- [Maintenance](#)
 - [Calibration/Cleaning](#)
 - [Cleaning Page](#)
3. Select [Print](#) to print the page.

A **Cleaning...** message displays on the printer control panel. The cleaning process takes a few minutes to complete. Do not turn the printer off until the cleaning process has finished. When it is finished, discard the printed page.

Visually inspect the toner cartridge

Follow these steps to inspect each toner cartridge.

1. Remove the toner cartridges from the printer, and verify that the sealing tape has been removed.
2. Check the memory chip for damage.
3. Examine the surface of the green imaging drum.

 **CAUTION:** Do not touch the imaging drum. Fingerprints on the imaging drum can cause print-quality problems.

4. If you see any scratches, fingerprints, or other damage on the imaging drum, replace the toner cartridge.
5. Reinstall the toner cartridge, and print a few pages to see if the problem has resolved.

Check paper and the printing environment

Step one: Use paper that meets HP specifications

Some print-quality problems arise from using paper that does not meet HP specifications.

- Always use a paper type and weight that this printer supports.
- Use paper that is of good quality and free of cuts, nicks, tears, spots, loose particles, dust, wrinkles, voids, staples, and curled or bent edges.
- Use paper that has not been previously printed on.
- Use paper that does not contain metallic material, such as glitter.
- Use paper that is designed for use in laser printers. Do not use paper that is designed only for use in Inkjet printers.
- Use paper that is not too rough. Using smoother paper generally results in better print quality.

Step two: Check the environment

The environment can directly affect print quality and is a common cause for print-quality or paper-feeding issues. Try the following solutions:

- Move the printer away from drafty locations, such as open windows or doors, or air-conditioning vents.
- Make sure the printer is not exposed to temperatures or humidity outside of printer specifications.
- Do not place the printer in a confined space, such as a cabinet.

- Place the printer on a sturdy, level surface.
- Remove anything that is blocking the vents on the printer. The printer requires good air flow on all sides, including the top.
- Protect the printer from airborne debris, dust, steam, grease, or other elements that can leave residue inside the printer.

Step three: Set the individual tray alignment

Follow these steps when text or images are not centered or aligned correctly on the printed page when printing from specific trays.

1. From the Home screen on the printer control panel, select the [Settings](#) menu.
2. Select the following menus:
 - [Copy/Print](#) or [Print](#)
 - [Print Quality](#)
 - [Image Registration](#)
3. Select [Tray](#), and then select the tray to adjust.
4. Select [Print Test Page](#), and then follow the instructions on the printed pages.
5. Select [Print Test Page](#) again to verify the results, and then make further adjustments if necessary.
6. Select [Done](#) to save the new settings.

Try a different print driver

Try a different print driver when printing from a software program and the printed pages have unexpected lines in graphics, missing text, missing graphics, incorrect formatting, or substituted fonts.

Download any of the following drivers from the HP Web site: www.hp.com/support/ljM631MFP, www.hp.com/support/ljM632MFP, or www.hp.com/support/ljM633MFP.

HP PCL.6 driver	<ul style="list-style-type: none"> • Provided as the default driver on the printer CD. This driver is automatically installed unless you select a different one.
HP PCL 6 driver	<ul style="list-style-type: none"> • Recommended for all Windows environments
HP PCL-6 driver	<ul style="list-style-type: none"> • Provides the overall best speed, print quality, and printer-feature support for most users • Developed to align with the Windows Graphic Device Interface (GDI) for the best speed in Windows environments • Might not be fully compatible with third-party and custom software programs that are based on PCL 5
HP UPD PS driver	<ul style="list-style-type: none"> • Recommended for printing with Adobe® software programs or with other highly graphics-intensive software programs • Provides support for printing from postscript emulation needs, or for postscript flash font support

HP UPD PCL 5	<ul style="list-style-type: none">• Recommended for general office printing in Windows environments• Compatible with previous PCL versions and older HP LaserJet printers• The best choice for printing from third-party or custom software programs• The best choice when operating with mixed environments, which require the printer to be set to PCL 5 (UNIX, Linux, mainframe)• Designed for use in corporate Windows environments to provide a single driver for use with multiple printer models• Preferred when printing to multiple printer models from a mobile Windows computer
HP UPD PCL 6	<ul style="list-style-type: none">• Recommended for printing in all Windows environments• Provides the overall best speed, print quality, and printer feature support for most users• Developed to align with Windows Graphic Device Interface (GDI) for best speed in Windows environments• Might not be fully compatible with third-party and custom software programs that are based on PCL 5

Check the EconoMode settings

HP does not recommend the full-time use of EconoMode. If EconoMode is used full-time, the toner supply might outlast the mechanical parts in the toner cartridge. If print quality begins to degrade and is no longer acceptable, consider replacing the toner cartridge.

 **NOTE:** This feature is available with the PCL 6 print driver for Windows. If you are not using that driver, you can enable the feature by using the HP Embedded Web Server.

Follow these steps if the entire page is too dark or too light.

1. From the software program, select the **Print** option.
2. Select the printer, and then click the **Properties** or **Preferences** button.
3. Click the **Paper/Quality** tab, and locate the **Print Quality** area.
4. If the entire page is too dark, use these settings:
 - Select the **600 dpi** option.
 - Select the **EconoMode** check box to enable it.If the entire page is too light, use these settings:
 - Select the **FastRes 1200** option.
 - Clear the **EconoMode** check box to disable it.
5. Click the **OK** button to close the **Document Properties** dialog box. In the **Print** dialog, click the **OK** button to print the job.

Adjust print density

Complete the following steps to adjust the print density.

1. From the Home screen on the printer control panel, select the [Settings](#) menu.
2. Open the following menus:
 - [Copy/Print](#) or [Print](#)
 - [Print Quality](#)
 - [Toner Density](#)
3. Move the slider toward either [Less](#) or [More](#) to the desired density setting.

Image defects table

Table 9-1 Image defects table quick reference

[Table 9-2 Light print on page 211](#)

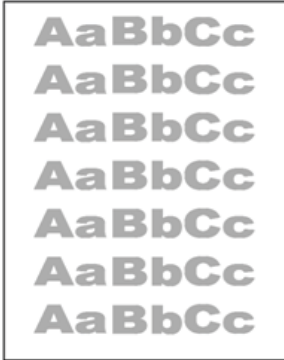

[Table 9-3 Gray background or dark print on page 211](#)



[Table 9-4 Blank page — No print on page 212](#)

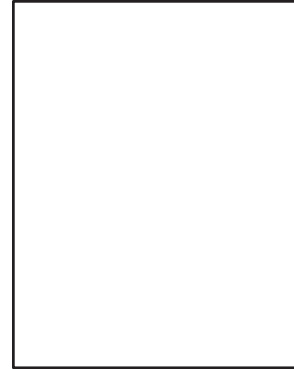

[Table 9-5 Black page on page 212](#)



[Table 9-6 Banding defects on page 213](#)



[Table 9-7 Streak defects on page 213](#)

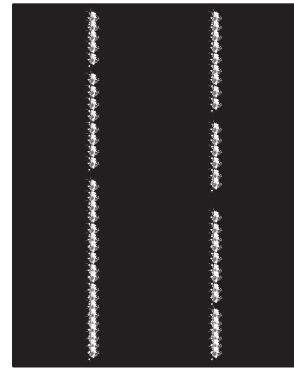

Table 9-1 Image defects table quick reference (continued)

Table 9-8 Fixing/fuser defects on page 214

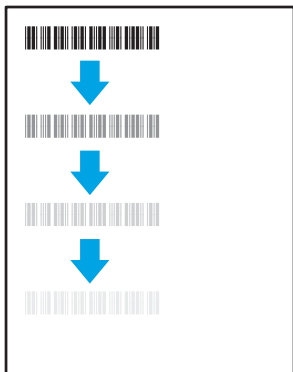

Table 9-9 Image placement defects on page 214



Table 9-10 Color plane registrations defects (color models only) on page 215

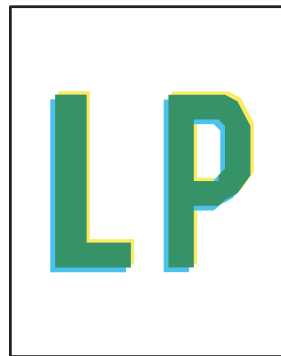

Table 9-11 Output defects on page 215

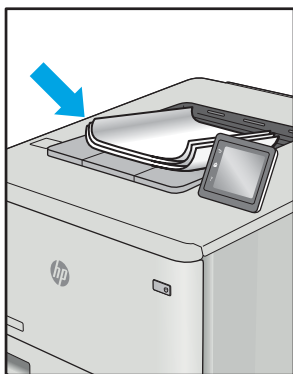



Image defects, no matter the cause, can often be resolved using the same steps. Use the following steps as a starting point for solving image defect issues.

1. Reprint the document. Print quality defects can be intermittent in nature or can go away completely with continued printing.
2. Check the condition of the cartridge or cartridges. If a cartridge is in a **Very Low** state (it has passed the rated life), replace the cartridge.
3. Make sure that the driver and tray print mode settings match the media that is loaded in the tray. Try using a different ream of media or a different tray. Try using a different print mode.
4. Make sure that the printer is within the supported operating temperature/humidity range.
5. Make sure that the paper type, size, and weight are supported by the printer. See the printer support page at support.hp.com for a list of the supported paper sizes and types for the printer.

 **NOTE:** The term “fusing” refers to the part of the printing process where toner is affixed to paper.

The following examples depict letter-size paper that has passed through the printer short-edge first.

Table 9-2 Light print

Description	Sample	Possible solutions
<p>Light print:</p> <p>The printed content on the entire page is light or faded.</p>		<ol style="list-style-type: none"> 1. Reprint the document. 2. Remove the cartridge, and then shake it to redistribute the toner. 3. Mono models only: Make sure that the Economode setting is disabled both at the printer control panel and in the print driver. 4. Make sure that the cartridge is installed correctly. 5. Print a Supply status page and check for life and usage of the cartridge. 6. Replace the cartridge. 7. If the problem persists, go to support.hp.com.

Table 9-3 Gray background or dark print

Description	Sample	Possible solutions
<p>Gray background or dark print:</p> <p>The image or text is darker than expected.</p>		<ol style="list-style-type: none"> 1. Make sure that the paper in the trays has not already been run through the printer. 2. Use a different paper type. 3. Reprint the document. 4. Mono models only: From the Home screen on the printer control panel, go to the Adjust Toner Density menu, and then adjust the toner density to a lower level. 5. Make sure that the printer is in within the supported operating temperature and humidity range. 6. Replace the cartridge. 7. If the problem persists, go to support.hp.com.

Table 9-4 Blank page — No print

Description	Sample	Possible solutions
<p>Blank page — No print:</p> <p>The page is completely blank and contains no printed content.</p>		<ol style="list-style-type: none">1. Make sure that the cartridge is genuine HP cartridges.2. Make sure that the cartridge is installed correctly.3. Print with a different cartridge.4. Check the paper type in the paper tray and adjust the printer settings to match. If necessary, select a lighter paper type.5. If the problem persists, go to support.hp.com.

Table 9-5 Black page

Description	Sample	Possible solutions
<p>Black page:</p> <p>The entire printed page is black.</p>		<ol style="list-style-type: none">1. Visually inspect the cartridge to check for damage.2. Make sure that the cartridge is installed correctly.3. Replace the cartridge4. If the problem persists, go to support.hp.com.

Table 9-6 Banding defects

Description	Sample	Possible solutions
<p>Repetitive wide-pitch banding and Impulse bands:</p> <p>Dark or light lines which repeat down the length of the page. They might be sharp or soft in nature. The defect displays only in areas of fill, not in text or sections with no printed content.</p>		<ol style="list-style-type: none"> 1. Reprint the document. 2. Try printing from another tray. 3. Replace the cartridge. 4. Use a different paper type. 5. Enterprise models only: From the Home screen on the printer control panel, go to the Adjust Paper Types menu, and then choose a print mode that is designed for a slightly heavier media than what you are using. This slows the print speed and might improve the print quality. 6. If the problem persists, go to support.hp.com.

Table 9-7 Streak defects

Description	Sample	Possible solutions
<p>Light vertical streaks:</p> <p>Light streaks that usually span the length of the page. The defect displays only in areas of fill, not in text or sections with no printed content.</p>		<ol style="list-style-type: none"> 1. Reprint the document. 2. Remove the cartridge, and then shake it to redistribute the toner. 3. If the problem persists, go to support.hp.com. <p>NOTE: Both light and dark vertical streaks can occur when the printing environment is outside the specified range for temperature or humidity. Refer to your printer's environmental specifications for allowable temperature and humidity levels.</p>
<p>Dark vertical streaks and ITB cleaning streaks (color models only):</p> <p>Dark lines which occur down the length of the page. The defect might occur anywhere on the page, in areas of fill or in sections with no printed content.</p>		<ol style="list-style-type: none"> 1. Reprint the document. 2. Remove the cartridge, and then shake it to redistribute the toner. 3. Print a cleaning page. 4. Check the toner level in the cartridge. 5. If the problem persists, go to support.hp.com.

Table 9-8 Fixing/fuser defects

Description	Fixing/fuser	Possible solutions
<p>Hot fuser offset (shadow):</p> <p>Slight shadows, or offsets, of the image repeated down the page. The repeated image might fade with each recurrence.</p>		<ol style="list-style-type: none"> 1. Reprint the document. 2. Check the paper type in the paper tray and adjust the printer settings to match. If necessary, select a lighter paper type. 3. If the problem persists, go to support.hp.com.
<p>Poor fusing:</p> <p>Toner rubs off along either edge of page. This defect is more common at the edges of high-coverage jobs and on light media types but can occur anywhere on the page.</p>		<ol style="list-style-type: none"> 1. Reprint the document. 2. Check the paper type in the paper tray and adjust the printer settings to match. If necessary, select a heavier paper type. 3. Enterprise models only: From the printer control panel, go to the Edge-to-Edge menu and then select Normal. Reprint the document. 4. Enterprise models only: From the printer control panel, select Auto Include Margins and then reprint the document. 5. If the problem persists, go to support.hp.com.

Table 9-9 Image placement defects

Description	Sample	Possible solutions
<p>Margins and skew:</p> <p>The image is not centered, or is skewed on the page. The defect occurs when the paper is not positioned properly as it is pulled from the tray and moves through the paper path.</p>		<ol style="list-style-type: none"> 1. Reprint the document. 2. Remove the paper and then reload the tray. Make sure that all the paper edges are even on all sides. 3. Make sure that the top of the paper stack is below the tray full indicator. Do not overfill the tray. 4. Make sure that the paper guides are adjusted to the correct size for the paper. Do not adjust the paper guides tightly against the paper stack. Adjust them to the indentations or markings in the tray. 5. If the problem persists, go to support.hp.com.

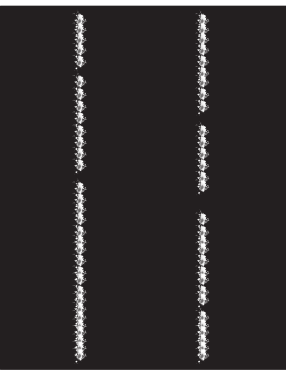
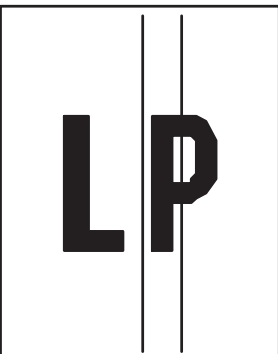
Table 9-10 Color plane registrations defects (color models only)

Description	Sample	Possible solutions
<p>Color plane registrations:</p> <p>One or more color of the planes is not aligned with the other color planes. The primary error will typically occur with yellow.</p>		<ol style="list-style-type: none"> 1. Reprint the document. 2. From the printer control panel, calibrate the printer. 3. If a cartridge has reached a Very Low state or the printed output is severely faded, replace the cartridge. 4. From the printer control panel use the Restore Calibration feature to reset the printer's calibration settings to the factory defaults. 5. If the problem persists, go to support.hp.com.

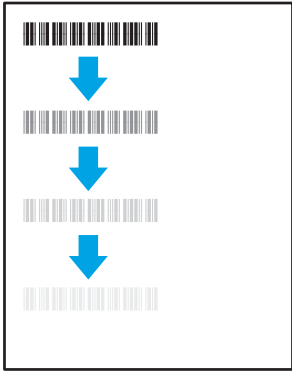
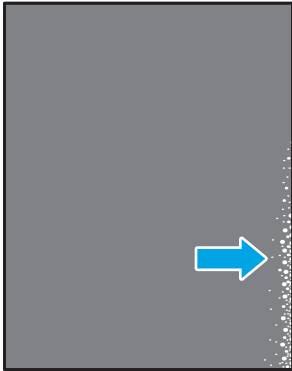
Table 9-11 Output defects

Description	Sample	Possible solutions
<p>Output curl:</p> <p>Printed paper has curled edges. The curled edge can be along the short or long side of the paper. Two types of curl are possible:</p> <ul style="list-style-type: none"> • Positive curl: The paper curls toward the printed side. The defect occurs in dry environments or when printing high coverage pages. • Negative curl: The paper curls away from the printed side. The defect occurs in high-humidity environments or when printing low coverage pages. 		<ol style="list-style-type: none"> 1. Reprint the document. 2. Positive curl: From the printer control panel, select a heavier paper type. The heavier paper type creates a higher temperature for printing. Negative curl: From the printer control panel, select a lighter paper type. The lighter paper type creates a lower temperature for printing. Try storing the paper in a dry environment prior or use freshly opened paper. 3. Print in duplex mode. 4. If the problem persists, go to support.hp.com.
<p>Output stacking:</p> <p>The paper does not stack well in the output tray. The stack might be uneven, skewed, or the pages might be pushed out of the tray and onto the floor. Any of the following conditions can cause this defect:</p> <ul style="list-style-type: none"> • Extreme paper curl • The paper in the tray is wrinkled or deformed • The paper is a non-standard paper type, such as envelopes • The output tray is too full 		<ol style="list-style-type: none"> 1. Reprint the document. 2. Extend the output bin extension. 3. If the defect is caused by extreme paper curl, complete the troubleshooting steps for Output curl. 4. Use a different paper type. 5. Use freshly opened paper. 6. Remove the paper from the output tray before the tray gets too full. 7. If the problem persists, go to support.hp.com.

Improve copy image quality

If the printer is having copy quality problems, try the following solutions in the order presented to resolve the issue.

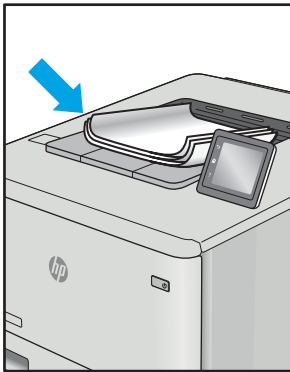
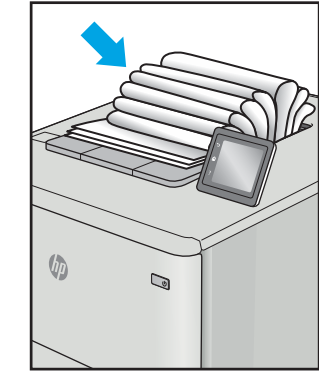
- [Check the scanner glass for dirt and smudges](#)
- [Calibrate the scanner](#)
- [Check the paper settings](#)
- [Check the image-adjustment settings](#)
- [Optimize copy quality for text or pictures](#)
- [Edge-to-edge copying](#)

Try these few simple steps first:

- Use the flatbed scanner rather than the document feeder.
- Use high-quality originals.
- When using the document feeder, load the original document into the feeder correctly, using the paper guides, to avoid unclear or skewed images.

If the problem still exists, try these additional solutions. If they do not fix the problem, see “Improve print quality” for further solutions.

Check the scanner glass for dirt and smudges

Over time, specks of debris might collect on the scanner glass and white plastic backing, which can affect performance. Use the following procedure to clean the scanner if the printed pages have streaks, unwanted lines, black dots, poor print quality, or unclear text.

1. Press the power button to turn the printer off, and then disconnect the power cable from the electrical outlet.



2. Open the scanner lid.

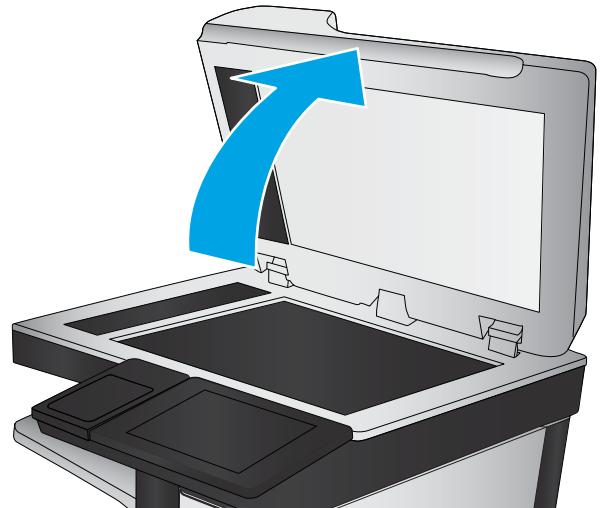

3. Clean the scanner glass and the document feeder strips with a soft cloth or sponge that has been moistened with nonabrasive glass cleaner.

CAUTION: Do not use abrasives, acetone, benzene, ammonia, ethyl alcohol, or carbon tetrachloride on any part of the printer; these can damage the printer. Do not place liquids directly on the glass or platen. They might seep and damage the printer.

NOTE: If you are having trouble with streaks on copies when you are using the document feeder, be sure to clean the small strip of glass on the left side of the scanner.

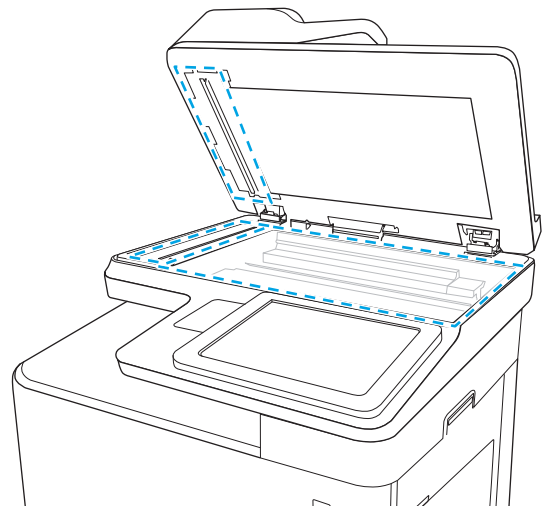

4. Dry the glass and white plastic parts with a chamois or a cellulose sponge to prevent spotting.
5. Connect the power cable to an outlet, and then press the power button to turn the printer on.

Calibrate the scanner

If the copied image is not positioned correctly on the page, follow these steps to calibrate the scanner.

 **NOTE:** When using the document feeder, make sure to adjust the guides in the input tray so they are against the original document.

1. From the Home screen on the printer control panel, swipe until the [Support Tools](#) menu displays. Touch the [Support Tools](#) icon to open the menu.
2. Open the following menus:

- [Maintenance](#)
 - [Calibration/Cleaning](#)
 - [Calibrate Scanner](#)
3. Touch the [Start](#) button to start the calibration process. Follow the on-screen prompts.
 4. Wait while the printer calibrates, and then try copying again.

Check the paper settings

Follow these steps if copied pages have smears, fuzzy or dark print, curled paper, scattered dots of toner, loose toner, or areas where toner has dropped out.

Check the paper size and type configuration

1. From the Home screen on the printer control panel, select [Copy](#).
2. In the Options pane, scroll to and select [Paper Selection](#).
3. Select [Paper Size](#), and then select one of the predefined options.
4. Select [Paper Type](#), and then select one of the predefined options.
5. Touch the [Done](#) button.

Select the tray to use for the copy

1. From the Home screen on the printer control panel, select [Copy](#).
2. In the Options pane, scroll to and select [Paper Selection](#).
3. Select [Paper Tray](#), and then select one of the paper trays.
4. Touch the [Done](#) button.

 **NOTE:** These settings are temporary. After you have finished the job, the printer returns to the default settings.

Check the image-adjustment settings

Adjust these additional settings to improve copy quality:

- **Sharpness:** Clarify or soften the image. For example, increasing the sharpness could make text appear crisper, but decreasing it could make photos appear smoother.
- **Darkness:** Increase or decrease the amount of white and black used in colors in scanned images.
- **Contrast:** Increase or decrease the difference between the lightest and the darkest color on the page.
- **Background Cleanup:** Remove faint colors from the background of scanned images. For example, if the original document is printed on colored paper, use this feature to lighten the background without affecting the darkness of the image.
- **Automatic Tone:** Available for Flow printers only. For original documents that have at least 100 characters of text on the page, the printer can detect which edge is the top of the page, and it orients the scanned images appropriately. If some of the pages are upside-down in relation to the other pages, the resulting

scanned image has all pages right-side-up. If some of the pages have a landscape orientation, the printer rotates the image so that the top of the page is at the top of the image.

1. From the Home screen on the printer control panel, select [Copy](#).
2. In the Options list, scroll to and select [Image Adjustment](#).
3. Adjust the sliders to set the levels, and then touch the [Done](#) button.
4. Touch the [Start](#) button.

 **NOTE:** These settings are temporary. After you have finished the job, the printer returns to the default settings.

Optimize copy quality for text or pictures

Optimize the copy job for the type of image being copied: text, graphics, or photos.

1. From the Home screen on the printer control panel, select [Copy](#).
2. In the Options pane, scroll to and select [Optimize Text/Picture](#).
3. Select one of the predefined options, or select [Automatically detect](#).
4. Touch the [Start](#) button.

 **NOTE:** These settings are temporary. After you have finished the job, the printer returns to the default settings.

Edge-to-edge copying

Use this feature to avoid shadows that can appear along the edges of copies when the original document is printed close to the edges.

1. From the Home screen on the printer control panel, select [Copy](#).
2. In the Options pane, scroll to and select [Edge-To-Edge](#).
3. Select the [Edge-To-Edge output](#) option if the original document is printed close to the paper edges.
4. Touch the [Start](#) button.

Improve scan image quality

- [Check the scanner glass for dirt and smudges](#)
- [Check the resolution settings](#)
- [Check the image-adjustment settings](#)
- [Optimize scan quality for text or pictures](#)
- [Check the output-quality settings](#)

Try these few simple steps first:

- Use the flatbed scanner rather than the document feeder.
- Use high-quality originals.
- When using the document feeder, load the original document into the feeder correctly, using the paper guides, to avoid unclear or skewed images.

If the problem still exists, try these additional solutions. If they do not fix the problem, see “Improve print quality” for further solutions.

Check the scanner glass for dirt and smudges

Over time, specks of debris might collect on the scanner glass and white plastic backing, which can affect performance. Use the following procedure to clean the scanner if the printed pages have streaks, unwanted lines, black dots, poor print quality, or unclear text.

1. Press the power button to turn the printer off, and then disconnect the power cable from the electrical outlet.



2. Open the scanner lid.

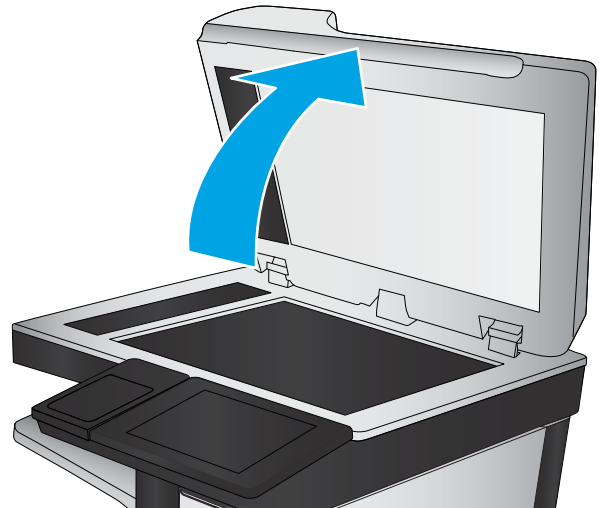

3. Clean the scanner glass and the document feeder strips with a soft cloth or sponge that has been moistened with nonabrasive glass cleaner.

CAUTION: Do not use abrasives, acetone, benzene, ammonia, ethyl alcohol, or carbon tetrachloride on any part of the printer; these can damage the printer. Do not place liquids directly on the glass or platen. They might seep and damage the printer.

NOTE: If you are having trouble with streaks on copies when you are using the document feeder, be sure to clean the small strip of glass on the left side of the scanner.

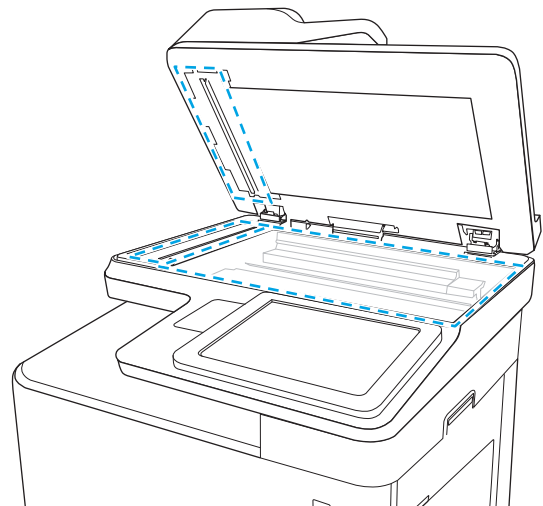

4. Dry the glass and white plastic parts with a chamois or a cellulose sponge to prevent spotting.
5. Connect the power cable to an outlet, and then press the power button to turn the printer on.

Check the resolution settings

 **NOTE:** Setting the resolution to a high value increases the file size and the scan time.

Follow these steps to adjust the resolution setting:

1. From the Home screen on the printer control panel, select [Scan](#).
2. Select one of the following Scan features:
 - [Scan to Email](#)
 - [Scan to Network Folder](#)

- [Scan to USB](#)
 - [Scan to SharePoint®](#)
3. Touch the [Options](#) button.
 4. In the Options pane, scroll to and select [File Type and Resolution](#).
 5. Select one of the predefined [Resolution](#) options, and then touch [Done](#). Touch [Send](#).

Check the image-adjustment settings

Adjust these additional settings to improve scan quality:

- [Sharpness](#): Clarify or soften the image. For example, increasing the sharpness could make text appear crisper, but decreasing it could make photos appear smoother.
- [Darkness](#): Increase or decrease the amount of white and black used in colors in scanned images.
- [Contrast](#): Increase or decrease the difference between the lightest and the darkest color on the page.
- [Background Cleanup](#): Remove faint colors from the background of scanned images. For example, if the original document is printed on colored paper, use this feature to lighten the background without affecting the darkness of the image.
- [Automatic Tone](#): Available for Flow printers only. For original documents that have at least 100 characters of text on the page, the printer can detect which edge is the top of the page, and it orients the scanned images appropriately. If some of the pages are upside-down in relation to the other pages, the resulting scanned image has all pages right-side-up. If some of the pages have a landscape orientation, the printer rotates the image so that the top of the page is at the top of the image.

1. From the Home screen on the printer control panel, select [Scan](#).
2. Select one of the following Scan features:
 - [Save to Device Memory](#)
 - [Scan to E-mail](#)
 - [Scan to Network Folder](#)
 - [Scan to USB](#)
 - [Scan to SharePoint®](#)
3. Touch the [Options](#) button.
4. In the Options pane, scroll to and select [Image Adjustment](#).
5. Adjust the sliders to set the levels.
6. Touch the [Send](#) button.



NOTE: These settings are temporary. After you have finished the job, the printer returns to the default settings.

Optimize scan quality for text or pictures

Optimize the scan job for the type of image being scanned: text, graphics, or photos.

1. From the Home screen on the printer control panel, select [Scan](#).
2. Select one of the following Scan features:
 - [Save to Device Memory](#)
 - [Scan to E-mail](#)
 - [Scan to Network Folder](#)
 - [Scan to USB](#)
 - [Scan to SharePoint®](#)
3. Touch the [Options](#) button.
4. In the Options pane, scroll to and select [Optimize Text/Picture](#).
5. Select one of the predefined options, or select [Automatically detect](#).
6. Touch the [Send](#) button.

 **NOTE:** These settings are temporary. After you have finished the job, the printer returns to the default settings.

Check the output-quality settings

This setting adjusts the level of compression when saving the file. For the highest quality, select the highest setting.

1. From the Home screen on the printer control panel, select [Scan](#).
2. Select one of the following Scan features:
 - [Scan to Email](#)
 - [Scan to Network Folder](#)
 - [Scan to USB](#)
 - [Scan to SharePoint®](#)
3. Touch the [Options](#) button.
4. In the Options pane, scroll to and select [File Type and Resolution](#).
5. Select one of the predefined [Quality and File Size](#) options, and then touch [Done](#). Touch [Send](#).

Improve fax image quality

If the printer is having fax quality problems, try the following solutions in the order presented to resolve the issue.

- [Check the scanner glass for dirt and smudges](#)
- [Check the send-fax resolution settings](#)
- [Check the image-adjustment settings](#)
- [Optimize fax quality for text or pictures](#)
- [Check the error-correction settings](#)
- [Check the fit-to-page setting](#)
- [Send to a different fax machine](#)
- [Check the sender's fax machine](#)

Try these few simple steps first:

- Use the flatbed scanner rather than the document feeder.
- Use high-quality originals.
- When using the document feeder, load the original document into the feeder correctly, using the paper guides, to avoid unclear or skewed images.

If the problem still exists, try these additional solutions. If they do not fix the problem, see “Improve print quality” for further solutions.

Check the scanner glass for dirt and smudges

Over time, specks of debris might collect on the scanner glass and white plastic backing, which can affect performance. Use the following procedure to clean the scanner if the printed pages have streaks, unwanted lines, black dots, poor print quality, or unclear text.

1. Press the power button to turn the printer off, and then disconnect the power cable from the electrical outlet.



2. Open the scanner lid.

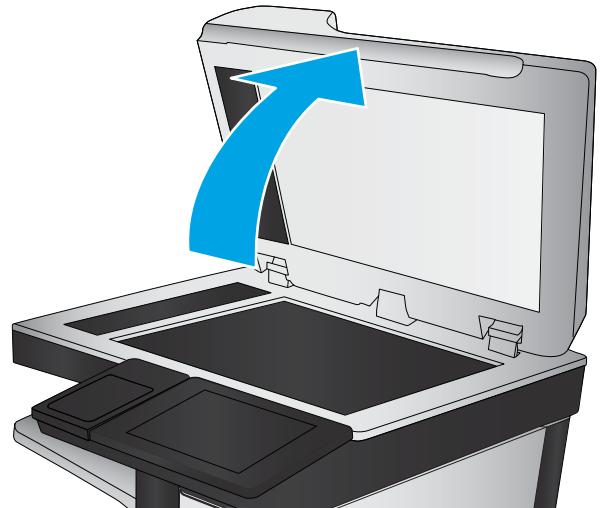

3. Clean the scanner glass and the document feeder strips with a soft cloth or sponge that has been moistened with nonabrasive glass cleaner.

CAUTION: Do not use abrasives, acetone, benzene, ammonia, ethyl alcohol, or carbon tetrachloride on any part of the printer; these can damage the printer. Do not place liquids directly on the glass or platen. They might seep and damage the printer.

NOTE: If you are having trouble with streaks on copies when you are using the document feeder, be sure to clean the small strip of glass on the left side of the scanner.

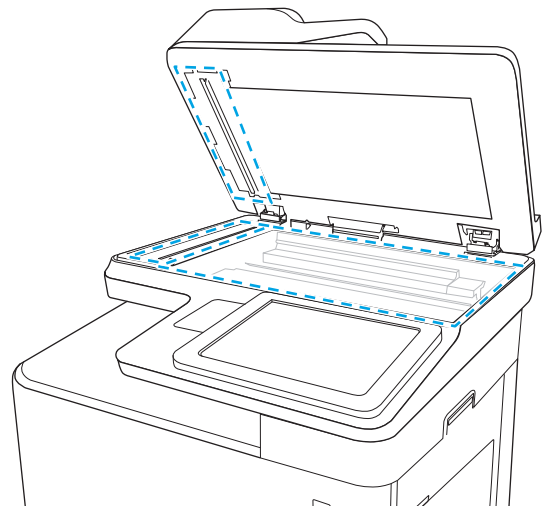

4. Dry the glass and white plastic parts with a chamois or a cellulose sponge to prevent spotting.
5. Connect the power cable to an outlet, and then press the power button to turn the printer on.

Check the send-fax resolution settings

Follow these steps to adjust the resolution of outgoing faxes.

 **NOTE:** Increasing the resolution increases the fax size and send time.

1. From the Home screen on the printer control panel, select **Scan**.
2. Touch the **Scan to Fax** button.
3. Touch the **Options** button.
4. In the Options pane, scroll to and select **Resolution**.
5. Select one of the predefined options, and then touch the **Send** button.

Check the image-adjustment settings

Adjust these additional settings to improve send-fax quality:

- **Sharpness:** Clarify or soften the image. For example, increasing the sharpness could make text appear crisper, but decreasing it could make photos appear smoother.
 - **Darkness:** Increase or decrease the amount of white and black used in colors in scanned images.
 - **Contrast:** Increase or decrease the difference between the lightest and the darkest color on the page.
 - **Background Cleanup:** Remove faint colors from the background of scanned images. For example, if the original document is printed on colored paper, use this feature to lighten the background without affecting the darkness of the image.
 - **Automatic Tone:** Available for Flow printers only. For original documents that have at least 100 characters of text on the page, the printer can detect which edge is the top of the page, and it orients the scanned images appropriately. If some of the pages are upside-down in relation to the other pages, the resulting scanned image has all pages right-side-up. If some of the pages have a landscape orientation, the printer rotates the image so that the top of the page is at the top of the image.
1. From the Home screen on the printer control panel, select [Scan](#).
 2. Touch the [Scan to Fax](#) button.
 3. Touch the [Options](#) button.
 4. In the Options pane, scroll to and select [Image Adjustment](#).
 5. Adjust the sliders to set the levels.
 6. Touch the [Send](#) button.

 **NOTE:** These settings are temporary. After you have finished the job, the printer returns to the default settings.

Optimize fax quality for text or pictures

Optimize the fax job for the type of image being scanned: text, graphics, or photos.

1. From the Home screen on the printer control panel, select [Scan](#).
2. Touch the [Scan to Fax](#) button.
3. Touch the [Options](#) button.
4. In the Options pane, scroll to and select [Optimize Text/Picture](#).
5. Select one of the predefined options, or select [Automatically detect](#).
6. Touch the [Send](#) button.

 **NOTE:** These settings are temporary. After you have finished the job, the printer returns to the default settings.

Check the error-correction settings

The [Error Correction Mode](#) setting might be disabled, which can reduce image quality. Follow these steps to re-enable the setting.

1. From the Home screen on the printer control panel, swipe until the [Settings](#) menu displays. Touch the [Settings](#) icon to open the menu.
2. Open the following menus:
 - [Fax](#)
 - [Fax Send Settings](#)
 - [General Fax Send Settings](#)
3. Select the [Error Correction Mode](#) option. Touch the [Done](#) button.

Check the fit-to-page setting

If the [Fit to Page](#) setting is enabled, and the incoming fax is larger than the default page size, the printer attempts to scale the image to fit the page. If this setting is disabled, larger images split across multiple pages.

1. From the Home screen on the printer control panel, swipe until the [Settings](#) menu displays. Touch the [Settings](#) icon to open the menu.
2. Open the following menus:
 - [Fax](#)
 - [Fax Receive Settings](#)
 - [Default Job Options](#)
 - [Fit to Page](#)
3. Touch the [On](#) option to enable the setting, or touch the [Off](#) option to disable it. Touch the [Done](#) button.

Send to a different fax machine

Try sending the fax to a different fax machine. If the fax quality is better, the problem is related to the initial recipient's fax machine settings or supplies status.

Check the sender's fax machine

Ask the sender to try sending from a different fax machine. If the fax quality is better, the problem is with the sender's fax machine. If a different fax machine is unavailable, ask the sender to consider making the following changes:

- Make sure the original document is on white (not colored) paper.
- Increase the fax resolution, quality level, or contrast settings.
- If possible, send the fax from a computer software program.

Solve wired network problems

Introduction

Certain types of problems can indicate there is a network communication problem. These problems include the following issues:

- The periodic loss of ability to communicate with the printer
- The printer cannot be found during driver installation
- A periodic failure to print

Check the following items to verify that the printer is communicating with the network. Before beginning, print a configuration page from the printer control panel and locate the printer IP address that is listed on this page.

- [Poor physical connection](#)
- [The computer is using the incorrect IP address for the printer](#)
- [The computer is unable to communicate with the printer](#)
- [The printer is using incorrect link and duplex settings for the network](#)
- [New software programs might be causing compatibility problems](#)
- [The computer or workstation might be set up incorrectly](#)
- [The printer is disabled, or other network settings are incorrect](#)



NOTE: HP does not support peer-to-peer networking, as the feature is a function of Microsoft operating systems and not of the HP print drivers. For more information, go to Microsoft at www.microsoft.com.

Poor physical connection

1. Verify that the printer is attached to the correct network port using a cable of the correct length.
2. Verify that cable connections are secure.
3. Look at the network port connection on the back of the printer, and verify that the amber activity light flashes indicating network traffic, and the green link-status light is continuously lit indicating a network link.
4. If the problem continues, try a different cable or port on the hub.

The computer is using the incorrect IP address for the printer

1. Open the printer properties and click the **Ports** tab. Verify that the current IP address for the printer is selected. The printer IP address is listed on the printer configuration page.
2. If you installed the printer using the HP standard TCP/IP port, select the box labeled **Always print to this printer, even if its IP address changes**.
3. If you installed the printer using a Microsoft standard TCP/IP port, use the hostname instead of the IP address.
4. If the IP address is correct, delete the printer and then add it again.

The computer is unable to communicate with the printer

1. Test network communication by pinging the network.
 - a. Open a command-line prompt on your computer.
 - For Windows, click **Start**, click **Run**, type `cmd`, and then press [Enter](#).
 - For OS X, go to **Applications**, then **Utilities**, and open **Terminal**.
 - b. Type `ping` followed by the IP address for your printer.
 - c. If the window displays round-trip times, the network is working.
2. If the ping command failed, verify that the network hubs are on, and then verify that the network settings, the printer, and the computer are all configured for the same network.

The printer is using incorrect link and duplex settings for the network

HP recommends leaving these settings in automatic mode (the default setting). If you change these settings, you must also change them for your network.

New software programs might be causing compatibility problems

Verify that any new software programs are correctly installed and that they use the correct print driver.

The computer or workstation might be set up incorrectly

1. Check the network drivers, print drivers, and the network redirection settings.
2. Verify that the operating system is configured correctly.

The printer is disabled, or other network settings are incorrect

1. Review the configuration page to check the status of the network protocol. Enable it if necessary.
2. Reconfigure the network settings if necessary.

Solve wireless network problems

- [Introduction](#)
- [Wireless connectivity checklist](#)
- [The printer does not print after the wireless configuration completes](#)
- [The printer does not print, and the computer has a third-party firewall installed](#)
- [The wireless connection does not work after moving the wireless router or printer](#)
- [Cannot connect more computers to the wireless printer](#)
- [The wireless printer loses communication when connected to a VPN](#)
- [The network does not appear in the wireless networks list](#)
- [The wireless network is not functioning](#)
- [Reduce interference on a wireless network](#)

Introduction

Use the troubleshooting information to help resolve issues.



NOTE: To determine whether HP NFC and Wireless Print Direct printing are enabled on your printer, print a configuration page from the printer control panel

Wireless connectivity checklist

- Verify that the network cable is not connected.
- Verify that the printer and the wireless router are turned on and have power. Also make sure that the wireless radio in the printer is turned on.
- Verify that the service set identifier (SSID) is correct. Print a configuration page to determine the SSID. If you are not sure the SSID is correct, run the wireless setup again.
- With secured networks, verify that the security information is correct. If the security information is incorrect, run the wireless setup again.
- If the wireless network is working correctly, try accessing other computers on the wireless network. If the network has Internet access, try connecting to the Internet over a wireless connection.
- Verify that the encryption method (AES or TKIP) is the same for the printer as it is for the wireless access point (on networks using WPA security).
- Verify that the printer is within the range of the wireless network. For most networks, the printer must be within 30 m (100 ft) of the wireless access point (wireless router).
- Verify that obstacles do not block the wireless signal. Remove any large metal objects between the access point and the printer. Make sure poles, walls, or support columns containing metal or concrete do not separate the printer and wireless access point.
- Verify that the printer is located away from electronic devices that might interfere with the wireless signal. Many devices can interfere with the wireless signal including motors, cordless phones, security system cameras, other wireless networks, and some Bluetooth devices.

- Verify that the print driver is installed on the computer.
- Verify that you have selected the correct printer port.
- Verify that the computer and printer connect to the same wireless network.
- For OS X, verify that the wireless router supports Bonjour.

The printer does not print after the wireless configuration completes

1. Make sure that the printer is turned on and in the ready state.
2. Turn off any third-party firewalls on your computer.
3. Make sure that the wireless network is working correctly.
4. Make sure that your computer is working correctly. If necessary, restart the computer.
5. Verify that you can open the printer HP Embedded Web Server from a computer on the network.

The printer does not print, and the computer has a third-party firewall installed

1. Update the firewall with the most recent update available from the manufacturer.
2. If programs request firewall access when you install the printer or try to print, make sure you allow the programs to run.
3. Temporarily turn off the firewall, and then install the wireless printer on the computer. Enable the firewall when you have completed the wireless installation.

The wireless connection does not work after moving the wireless router or printer

1. Make sure that the router or printer connects to the same network that your computer connects to.
2. Print a configuration page.
3. Compare the service set identifier (SSID) on the configuration page to the SSID in the printer configuration for the computer.
4. If the numbers are not the same, the devices are not connecting to the same network. Reconfigure the wireless setup for the printer.

Cannot connect more computers to the wireless printer

1. Make sure that the other computers are within the wireless range and that no obstacles block the signal. For most networks, the wireless range is within 30 m (100 ft) of the wireless access point.
2. Make sure that the printer is turned on and in the ready state.
3. Make sure there are not more than 5 concurrent Wireless Print Direct users.
4. Turn off any third-party firewalls on your computer.
5. Make sure that the wireless network is working correctly.
6. Make sure that your computer is working correctly. If necessary, restart the computer.

The wireless printer loses communication when connected to a VPN

- Typically, you cannot connect to a VPN and other networks at the same time.

The network does not appear in the wireless networks list

- Make sure the wireless router is turned on and has power.
- The network might be hidden. However, you can still connect to a hidden network.

The wireless network is not functioning

1. Make sure that the network cable is not connected.
2. To verify if the network has lost communication, try connecting other devices to the network.
3. Test network communication by pinging the network.
 - a. Open a command-line prompt on your computer.
 - For Windows, click **Start**, click **Run**, type `cmd`, and then press **Enter**.
 - For OS X, go to **Applications**, then **Utilities**, and open **Terminal**.
 - b. Type `ping` followed by the router IP address.
 - c. If the window displays round-trip times, the network is working.
4. Make sure that the router or printer connects to the same network that the computer connects to.
 - a. Print a configuration page.
 - b. Compare the service set identifier (SSID) on the configuration report to the SSID in the printer configuration for the computer.
 - c. If the numbers are not the same, the devices are not connecting to the same network. Reconfigure the wireless setup for the printer.

Reduce interference on a wireless network

The following tips can reduce interference in a wireless network:

- Keep the wireless devices away from large metal objects, such as filing cabinets, and other electromagnetic devices, such as microwaves and cordless telephones. These objects can disrupt radio signals.
- Keep the wireless devices away from large masonry structures and other building structures. These objects can absorb radio waves and lower signal strength.
- Position the wireless router in a central location in line of sight with the wireless printers on the network.

Solve fax problems

- [Checklist for solving fax problems](#)
- [General fax problems](#)

Checklist for solving fax problems

Use the following checklist to help identify the cause of any fax-related problems you encounter:

- **Are you using the fax cable supplied with the fax accessory?** This fax accessory has been tested with the supplied fax cable to meet RJ11 and functional specifications. Do not substitute another fax cable; the analog-fax accessory requires an analog-fax cable. It also requires an analog phone connection.
- **Is the fax/phone line connector seated in the outlet on the fax accessory?** Make sure that the phone jack is correctly seated in the outlet. Insert the connector into the outlet until it "clicks."



NOTE: Verify that the phone jack is connected to the fax port rather than to the network port. The ports are similar.

- **Is the phone wall jack working properly?** Verify that a dial tone exists by attaching a phone to the wall jack. Can you hear a dial tone, and can you make or receive a phone call?

What type of phone line are you using?

- **Dedicated line:** A standard analog fax/phone line assigned to receive or send faxes.



NOTE: The phone line should be for printer fax use only and not shared with other types of telephone devices. Examples include alarm systems that use the phone line for notifications to a monitoring company.

- **PBX system:** A business-environment phone system. Standard home phones and the fax accessory use an analog phone signal. Some PBX systems are digital and might not be compatible with the fax accessory. You might need an interfacing Analog Telephone Adapter (ATA) to connect the fax machine to digital PBX systems.
- **Roll-over lines:** A phone system feature where a new call "rolls over" to the next available line when the first incoming line is busy. Try attaching the printer to the first incoming phone line. The fax accessory answers the phone after it rings the number of times set in the rings-to-answer setting.

Are you using a surge-protection device?

A surge-protection device can be used between the wall jack and the fax accessory to protect the fax accessory against electrical power passed through the phone lines. These devices can cause some fax communication problems by degrading the quality of the phone signal. If you are having problems sending or receiving faxes and are using one of these devices, connect the printer directly to the phone jack on the wall to determine whether the problem is with the surge-protection device.

Are you using a phone company voice-messaging service or an answering machine?

If the rings-to-answer setting for the messaging service is lower than the rings-to-answer setting for the fax accessory, the messaging service answers the call, and the fax accessory cannot receive faxes. If the rings-to-answer setting for the fax accessory is lower than that of the messaging service, the fax accessory answers all calls.

Does your phone line have a call-waiting feature?

If the fax telephone line has an activated call-waiting feature, a call-waiting notice can interrupt a fax call in progress, which causes a communication error. Ensure that a call-waiting feature is not active on the fax telephone line.

Check fax accessory status

If the analog-fax accessory does not appear to be functioning, print a [Configuration Page](#) report to check the status.

1. From the Home screen, scroll to and select [Reports](#).
2. Open the following menus:
 - [Configuration/Status Pages](#)
 - [Configuration Page](#)
3. Touch the [Print](#) button to print the report, or touch the [View](#) button to view the report on the screen. The report consists of several pages.

 **NOTE:** The printer IP address or host name is listed on the Jetdirect Page.

On the Fax Accessory Page of the Configuration Page, under the Hardware Information heading, check the Modem Status. The following table identifies the status conditions and possible solutions.

 **NOTE:** If the Fax Accessory Page does not print, there might be a problem with the analog fax accessory. If you are using LAN fax or Internet fax, those configurations could be disabling the feature.

Operational / Enabled ¹	The analog-fax accessory is installed and ready.
Operational / Disabled ¹	The fax accessory is installed, but you have not configured the required fax settings yet. The fax accessory is installed and operational; however, the HP Digital Sending utility has either disabled the printer fax feature or has enabled LAN fax. When LAN fax is enabled, the analog-fax feature is disabled. Only one fax feature, either LAN fax or analog fax, can be enabled at a time. NOTE: If LAN fax is enabled, the Scan to Fax feature is unavailable on the printer control panel.
Non-Operational / Enabled/Disabled ¹	The printer has detected a firmware failure. Upgrade the firmware.
Damaged / Enabled/Disabled ¹	The fax accessory has failed. Reseat the fax accessory card and check for bent pins. If the status is still DAMAGED, replace the analog-fax accessory card.

¹ ENABLED indicates that the analog-fax accessory is enabled and turned on; DISABLED indicates that LAN fax is enabled (analog fax is turned off).

General fax problems

The following are some common fax problems.

The fax failed to send

JBIG is enabled, and the receiving fax machine does not have JBIG capability.

Turn off the JBIG setting.

An Out of Memory status message displays on the printer control panel

The printer storage disk is full.

Delete some stored jobs from the disk. From the Home screen on the printer control panel, touch the [Retrieve from Device Memory](#) button. Open the list of stored jobs or stored faxes. Select a job to delete, and then touch the [Delete](#) button.

Print quality of a photo is poor or prints as a gray box

You are using the wrong page-content setting or the wrong resolution setting.

Try setting the [Optimize Text/Picture](#) option to [Photograph](#) setting.

You touched the Stop button to cancel a fax, but the fax was still sent

If the job is too far along in the sending process, you cannot cancel the job.

This is normal operation.

No fax address book button displays

None of the contacts in the selected contacts list have fax information associated with them.

Not able to locate the Fax settings in HP Web Jetadmin

Fax settings in HP Web Jetadmin are located under the device's status page drop-down menu.

Select **Digital Sending and Fax** from the drop-down menu.

The header is appended to the top of the page when the overlay option is enabled

For all forwarded faxes, the printer appends the overlay header to the top of a page.

This is normal operation.

A mix of names and numbers is in the recipients box

Names and numbers can both display, depending on where they are from. The fax address book lists names, and all other databases list numbers.

This is normal operation.

A one-page fax prints as two pages

The fax header is being appended to the top of the fax, pushing text to a second page.

To print a one page fax on one page, set the overlay header to overlay mode, or adjust the fit-to-page setting.

A document stops in the document feeder in the middle of faxing

A jam is in the document feeder.

Clear the jam, and send the fax again.

The volume for sounds coming from the fax accessory is too high or too low

The volume setting needs to be adjusted.

Adjust the volume in the [Fax Send Settings](#) menu and the [Fax Receive Settings](#) menu.

Index

Symbols/Numerics

2,100-sheet high-capacity input tray
loading 30

A

accessories
ordering 40
acoustic specifications 17
AirPrint 68
alternative letterhead mode 25, 29
Android devices
printing from 68

B

bins, output
locating 2
Bonjour
identifying 146
browser requirements
HP embedded Web Server 146

C

calibrate
scanner 217
cartridge
replacing 47
cartridge policy 43
cartridge protection 45
cartridges
order numbers 47
replacing staple 51
checklist
wireless connectivity 230
cleaning
glass 216, 220, 224
paper path 204
control panel
help 167

locating 2
locating features 5
copy
optimize for text or pictures 219
copy settings
HP Embedded Web Server 149
copying
both sides 76
multiple copies 74
resolution 9
single copies 74
customer support
online 166

D

default gateway, setting 156
deleting
stored jobs 65
digital send settings
HP Embedded Web Server 150
digital sending
folders 127
sending documents 125
USB 129
dimensions, printer 9, 14
document feeder
capacity 9
jams 181
locating 2
paper-feeding problems 177
double-sided printing
Mac 59
Windows 56
drivers, supported 11
duplex printing
Mac 59
duplex printing (double-sided)
settings (Windows) 56
Windows 56

duplexer
clearing jams 195
duplexing
manually (Mac) 59
manually (Windows) 56

E

easy-access USB printing 70
EconoMode setting 207
edge-to-edge copying 219
electrical specifications 17
email
sending documents 125
Embedded Web Server
changing network settings 155
changing printer name 155
opening 155
Embedded Web Server (EWS)
assigning passwords 158
features 146
network connection 146
energy use, optimizing 160
envelope feeder
clearing jams 196
envelopes
orientation 22
envelopes, loading 32
Ethernet (RJ-45)
locating 5
Explorer, versions supported
HP Embedded Web Server 146

F

fax
feeding problems 235
optimize for text or pictures 226
required settings 136
settings 137
setup 136

- fax port
 - locating 5
- fax settings
 - HP Embedded Web Server 151
 - required 136
- feeding problems 235
- FIH (foreign interface harness)
 - locating 5
- folders
 - sending to 127
- foreign interface harness (FIH)
 - locating 5
- formatter
 - locating 4
- fuser
 - clearing jams 192
- G**
- gateway, setting default 156
- general configuration
 - HP Embedded Web Server 148
- genuine HP cartridges 43
- glass, cleaning 216, 220, 224
- H**
- hard disks
 - encrypted 159
- hardware integration pocket (HIP)
 - locating 2
- Help button
 - locating 5
- help, control panel 167
- Hi-Speed USB 2.0 printing port
 - locating 5
- HIP (hardware integration pocket)
 - locating 2
- Home button
 - locating 5
- HP Customer Care 166
- HP Embedded Web Server
 - changing network settings 155
 - changing printer name 155
 - copy settings 149
 - digital send settings 150
 - fax settings 151
 - general configuration 148
 - HP Web Services 152
 - information pages 147
 - network settings 152
 - opening 155
 - other links list 154
 - print settings 149
 - scan settings 150
 - security settings 152
 - troubleshooting tools 151
- HP Embedded Web Server (EWS)
 - features 146
 - network connection 146
- HP ePrint 67
- HP ePrint software 67
- HP JetAdvantage business solutions 133
- HP Stapling Mailbox
 - clear jams 198
 - clear staple jams 200
- HP Web Jetadmin 162
- HP Web Services
 - enabling 152
- I**
- image quality
 - check toner-cartridge status 204
- image quality issues
 - examples and solutions 209
- information pages
 - HP Embedded Web Server 147
- interface ports
 - locating 5
- Internet Explorer, versions supported
 - HP Embedded Web Server 146
- IP Security 159
- IPsec 159
- IPv4 address 156
- IPv6 address 156
- J**
- jams
 - 2,100-sheet high-capacity input tray 188
 - auto-navigation 180
 - causes of 180
 - document feeder 181
 - duplexer 195
 - envelope feeder 196
 - fuser 192
 - HP Stapling Mailbox 198
 - output bin 195
 - right door 192
 - staples in the HP Stapling Mailbox 200
 - Tray 1 183
 - Trays 2, 3, 4, and 5 185
- jams, paper
 - locations 179
- Jetadmin, HP Web 162
- JetAdvantage 133
- jobs, stored
 - creating (Windows) 62
 - deleting 65
 - Mac settings 64
 - printing 64
- K**
- keyboard
 - locating 2
- L**
- label
 - orientation 34
- labels
 - printing (Windows) 57
 - printing on 34
- labels, loading 34
- LAN port
 - locating 5
- loading
 - paper in the 2,100-sheet high-capacity input tray 30
 - paper in Tray 1 21
 - paper in Tray 2 and the 550-sheet trays 26
- local area network (LAN)
 - locating 5
- lock
 - formatter 159
- lower right door
 - locating 2
- M**
- Mac driver settings
 - Job Storage 64
- Main input tray
 - loading labels 34
- maintenance kits
 - part numbers 41
- managing network 155
- manual duplex
 - Mac 59
 - Windows 56
- margins, small
 - copying 219

- memory
 - included 9
- memory chip (toner)
 - locating 47
- mobile printing
 - Android devices 68
- mobile printing solutions 9
- mobile printing, software supported 13
- multiple pages per sheet
 - printing (Mac) 60
 - printing (Windows) 57

N

- Near Field Communication printing 66
- Netscape Navigator, versions supported
 - HP embedded Web Server 146
- network
 - printer name, changing 155
 - settings, changing 155
 - settings, viewing 155
- network duplex settings, changing 157
- Network Folder, scan to 127
- network link speed settings, changing 157
- network settings
 - HP Embedded Web Server 152
- networks
 - default gateway 156
 - HP Web Jetadmin 162
 - IPv4 address 156
 - IPv6 address 156
 - subnet mask 156
 - supported 9
- NFC printing 66
- number of copies, changing 74

O

- on/off button
 - locating 2
- online help, control panel 167
- online support 166
- operating systems (OS)
 - supported 9
- operating systems, supported 11
- optimize copy images 219
- optimize fax images 226

- optimize scanned images 222
- ordering
 - supplies and accessories 40
- OS (operating system)
 - supported 9
- other links list
 - HP Embedded Web Server 154
- output bin
 - clear jams 195
- output bins
 - locating 2

P

- pages per minute 9
- pages per sheet
 - selecting (Mac) 60
 - selecting (Windows) 57
- paper
 - jams 180
 - loading the 2,100-sheet high-capacity input tray 30
 - loading Tray 1 21
 - loading Tray 2 and the 550-sheet trays 26
 - selecting 205
 - Tray 1 orientation 22
- paper jams
 - document feeder 181
 - HP Stapling Mailbox 198
 - locations 179
 - output bin 195
 - Tray 1 183
 - Tray 2, 3, 4, and 5 185
 - Tray 6 188
- paper pickup problems
 - solving 171, 173
- paper type
 - selecting (Windows) 57
- paper types
 - selecting (Mac) 60
- paper, ordering 40
- part numbers
 - replacement parts 41
 - staple cartridges 41
- ports
 - locating 5
- power
 - consumption 17
- power connection
 - locating 4

- power switch
 - locating 2
- power usage
 - 1 watt or less 160
- print drivers, supported 11
- print media
 - loading in Tray 1 21
- print on both sides
 - Mac 59
 - manually, Windows 56
 - Windows 56
- print settings
 - HP Embedded Web Server 149
- printing
 - from USB storage accessories 70
 - stored jobs 64
 - printing on both sides
 - settings (Windows) 56
- Priority input tray
 - loading labels 34
- private printing 62
- protect cartridges 45

R

- replacement parts
 - part numbers 41
- replacing
 - staple cartridges 51
 - toner cartridge 47
- required settings
 - fax 136
- resolution
 - copy and scan 9
- restore factory settings 168
- right door
 - clearing jams 192
 - locating 2
- RJ-45 port
 - locating 5

S

- scan settings
 - HP Embedded Web Server 150
- Scan to Network Folder 127
 - initial setup 95
- Scan to USB Drive 129
 - enabling 106
- scanner
 - calibrate 217
 - glass cleaning 216, 220, 224

- scanning
 - optimize for text or pictures 222
 - resolution 9
 - scanning to email
 - sending documents 125
 - scanning to folder 127
 - scanning to USB 129
 - security settings
 - HP Embedded Web Server 152
 - security
 - encrypted hard disk 159
 - security lock slot
 - locating 5
 - sending to email
 - sending documents 125
 - settings
 - fax 137
 - restore factory 168
 - Sign In button
 - locating 5
 - Sign Out button
 - locating 5
 - sleep mode 160
 - small margins 219
 - special paper
 - printing (Windows) 57
 - specifications
 - electrical and acoustic 17
 - speed, optimizing 160
 - stacking
 - configure the operation mode 37
 - staple cartridges
 - replacing 51
 - staple jams
 - HP Stapling Mailbox 200
 - stapler
 - setting default staple location 36
 - stapler/stacker accessory
 - configure the operation mode 37
 - stapling
 - configure the operation mode 37
 - setting default location 36
 - Start Copy button
 - locating 5
 - status, fax accessory page 234
 - storage, job
 - Mac settings 64
 - store print jobs 62
 - stored jobs
 - creating (Mac) 64
 - creating (Windows) 62
 - deleting 65
 - printing 64
 - storing jobs
 - with Windows 62
 - subnet mask 156
 - supplies
 - low threshold settings 169
 - ordering 40
 - part numbers 41
 - replacing staple cartridges 51
 - replacing toner cartridge 47
 - using when low 169
 - support
 - online 166
 - system requirements
 - HP Embedded Web Server 146
 - minimum 13
- T**
- TCP/IP
 - manually configuring IPv4
 - parameters 156
 - manually configuring IPv6
 - parameters 156
 - technical support
 - online 166
 - toner cartridge
 - components 47
 - low threshold settings 169
 - replacing 47
 - using when low 169
 - toner cartridges
 - order numbers 47
 - touchscreen
 - locating features 5
 - transparencies
 - printing (Windows) 57
 - Tray 1
 - jams 183
 - loading envelopes 32
 - paper orientation 22
 - Tray 2
 - jams 185
 - Tray 2 and the 550-sheet trays
 - loading 26
 - Tray 3
 - jams 185
 - Tray 4
 - jams 185
 - Tray 5
 - jams 185
 - Tray 6
 - paper jams 188
 - trays
 - capacity 9
 - included 9
 - locating 2
 - troubleshooting
 - check toner-cartridge status 204
 - jams 180
 - network problems 228
 - paper feed problems 171
 - wired network 228
 - wireless network 230
 - troubleshooting tools
 - HP Embedded Web Server 151
 - two-sided printing
 - settings (Windows) 56
- U**
- USB
 - sending to 129
 - USB port
 - enabling 70
 - locating 5
 - USB storage accessories
 - printing from 70
- W**
- Web browser requirements
 - HP Embedded Web Server 146
 - Web sites
 - customer support 166
 - HP Web Jetadmin, downloading 162
 - weight, printer 9, 14
 - Wi-Fi Direct printing 14
 - Wireless Direct Printing 66
 - wireless network
 - troubleshooting 230
 - wireless network interference 232