

# HP LaserJet M2727 MFP Series

## User Guide

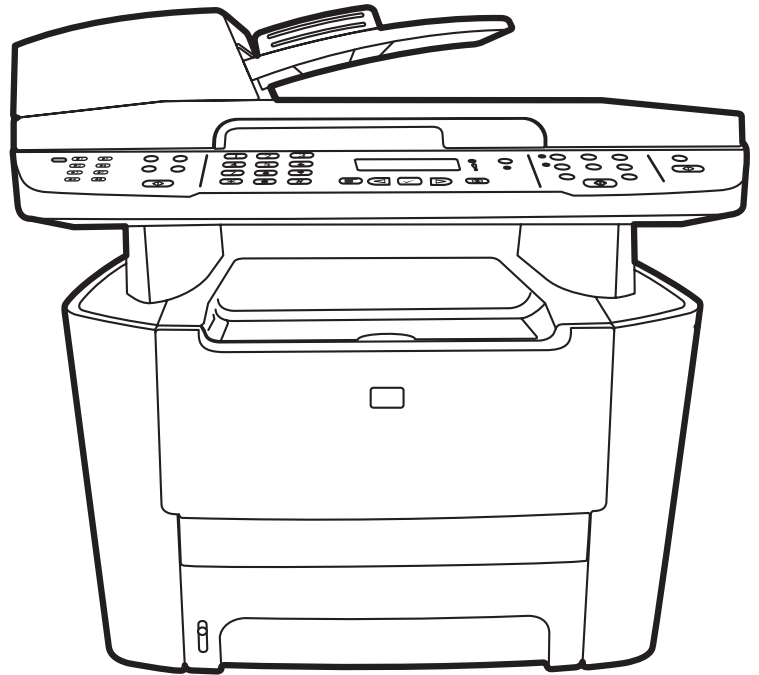



# HP LaserJet M2727 mfp

## User Guide



**Copyright and License**

© 2007 Copyright Hewlett-Packard  
Development Company, L.P.

Reproduction, adaptation, or translation  
without prior written permission is prohibited,  
except as allowed under the copyright laws.

Edition 2, 4/2009

Part number: CB532-90949

The information contained herein is subject  
to change without notice.

The only warranties for HP products and  
services are set forth in the express warranty  
statements accompanying such products  
and services. Nothing herein should be  
construed as constituting an additional  
warranty. HP shall not be liable for technical  
or editorial errors or omissions contained  
herein.

**Trademark Credits**

Adobe®, Acrobat®, and PostScript® are  
trademarks of Adobe Systems Incorporated.

Microsoft®, Windows®, and Windows NT®  
are U.S. registered trademarks of Microsoft  
Corporation.

UNIX® is a registered trademark of The Open  
Group.

---

# Table of contents

## 1 Product basics

Product comparison .....	2
Product features .....	3
Product walkaround .....	4
Front view .....	4
Back view .....	4
Interface ports .....	5
Serial number and model number location .....	5
Supported operating systems .....	6
Supported product software .....	6
Software included with the product .....	6
Supported printer drivers .....	7

## 2 Control panel

Control-panel walkaround .....	10
Control-panel menus .....	11
Use the control-panel menus .....	11
Control-panel main menus .....	11

## 3 Software for Windows

Supported operating systems for Windows .....	22
Supported printer drivers for Windows .....	22
Select the correct printer driver for Windows .....	22
Priority for print settings .....	23
Change printer-driver settings for Windows .....	23
Software installation types for Windows .....	24
Remove software for Windows .....	24
Supported utilities for Windows .....	25
HP ToolboxFX .....	25
Embedded Web server .....	25
HP Web Jetadmin .....	25
Other Windows components and utilities .....	25
Software for other operating systems .....	26

## 4 Use the product with Macintosh

Software for Macintosh .....	28
Supported operating systems for Macintosh .....	28
Supported printer drivers for Macintosh .....	28
Priority for print settings for Macintosh .....	28
Change printer-driver settings for Macintosh .....	28
Software installation types for Macintosh .....	29
Remove software from Macintosh operating systems .....	30
Supported utilities for Macintosh .....	30
Use features in the Macintosh printer driver .....	32
Print .....	32
Scan from the product and HP Director (Macintosh) .....	35
Scanning tasks .....	35
Fax a document from a Macintosh computer .....	36

## 5 Connectivity

Connect the product directly to a computer with USB .....	38
Printer sharing disclaimer .....	38
Supported network operating systems .....	38
Supported network protocols .....	39
Install the product on a network .....	40
Configure the network product .....	41
View settings .....	41
Change settings .....	41
IP address .....	42
Link speed setting .....	42

## 6 Paper and print media

Understand paper and print media use .....	46
Supported paper and print media sizes .....	47
Special paper or print media guidelines .....	48
Load paper and print media .....	49
Tray 1 .....	49
Tray 2 or 3 .....	50
Configure trays .....	51
Change tray selection .....	51

## 7 Print tasks

Change the print driver to match the media type and size .....	54
Supported paper types and tray capacity .....	54
Get help for any print option .....	55
Cancel a print job .....	56
Create booklets .....	57

Change print-quality settings .....	57
Change print density .....	57
Print on special media .....	58
Use different paper and print covers .....	59
Print a blank first page .....	59
Resize documents .....	60
Select a paper size .....	60
Select a paper source .....	60
Select a paper type .....	60
Set the print orientation .....	61
Use watermarks .....	61
Save toner .....	61
Create and use printing shortcuts in Windows .....	62
Print on both sides of the paper (duplex printing) .....	63
Use automatic duplex printing .....	63
Print on both sides manually .....	63
Print multiple pages on one sheet of paper in Windows .....	64
Economy settings .....	65
EconoMode .....	65
Archive print .....	65
Fonts .....	65
Select fonts .....	65
Print lists of available fonts .....	65

## 8 Copy

Load originals .....	68
Use copy .....	69
One-touch copy .....	69
Multiple copies .....	69
Cancel a copy job .....	70
Reduce or enlarge copies .....	70
Change the copy-collation setting .....	71
Copy settings .....	72
Copy quality .....	72
Define custom copy settings .....	74
Copy onto media of different types and sizes .....	74
Restore the copy-settings defaults .....	76
Copy a book .....	76
Copy photos .....	76
Copy mixed-size originals .....	78
Duplex (two-sided) copy jobs .....	78
Copy two-sided documents automatically .....	78
Copy two-sided documents manually .....	79

## 9 Scan

Load originals for scanning .....	82
Use scan .....	83
Scan methods .....	83
Use the Scan To feature .....	85
Canceling a scan job .....	86
Scan settings .....	87
Scan file format .....	87
Scanner resolution and color .....	87
Scan quality .....	88
Scan a book .....	90
Scan a photo .....	91

## 10 Fax

Fax features .....	94
Setup .....	95
Install and connect the hardware .....	95
Configure fax settings .....	97
Manage the phone book .....	99
Set fax polling .....	103
Security .....	103
Change fax settings .....	105
Set the sound-volume settings .....	105
Send fax settings .....	105
Receive fax settings .....	110
Use fax .....	116
Fax software .....	116
Cancel a fax .....	116
Delete faxes from memory .....	117
Use fax on a DSL, PBX, ISDN, or VoIP system .....	117
Send a fax .....	118
Receive a fax .....	127
Solve fax problems .....	129
Fax error messages .....	129
Fax memory is retained when there is a loss of power .....	132
Fax logs and reports .....	133
Change error correction and fax speed .....	135
Problems sending faxes .....	136
Problems receiving faxes .....	138
Performance problems .....	140

## 11 Manage and maintain the product

Information pages .....	142
-------------------------	-----



HP ToolboxFX .....	144
View HP ToolboxFX .....	144
Status .....	144
Alerts .....	145
Fax .....	145
Help .....	148
System Settings .....	149
Print Settings .....	151
Network Settings .....	152
Embedded Web server .....	153
Features .....	153
Use HP Web Jetadmin software .....	154
Security features .....	154
Secure the embedded Web server .....	154
Lock the control-panel menus .....	154
Private receive .....	154
Use the convenience stapler (HP LaserJet M2727nfs mfp only) .....	155
Staple documents .....	155
Load staples .....	156
Manage supplies .....	157
Check and order supplies .....	157
Replace supplies .....	159
Clean the product .....	162
Firmware updates .....	165

## 12 Problem solve

Problem-solving checklist .....	168
Restore the factory-set defaults .....	169
Control-panel messages .....	170
Alert and warning messages .....	170
Critical error messages .....	174
Control-panel display problems .....	176
Clear jams .....	176
Causes of jams .....	176
Where to look for jams .....	177
Clear jams from the ADF .....	177
Clear jams from the input-tray areas .....	180
Clear jams from the duplexer .....	183
Clear jams from the output-bin areas .....	185
Clear jams from the print-cartridge area .....	187
Clear jams from the convenience stapler (HP LaserJet M2727nfs mfp only) .....	188
Avoid repeated jams .....	189
Solve image-quality problems .....	190

Print problems .....	190
Copy problems .....	197
Scan problems .....	201
Fax problems .....	203
Optimize and improve image quality .....	204
Solve convenience stapler problems .....	206
Solve connectivity problems .....	206
Solve direct-connection problems .....	206
Network problems .....	206
Solve software problems .....	208
Solve common Windows problems .....	208
Solve common Macintosh problems .....	208
Solve PostScript (PS) errors .....	210

## Appendix A Accessories and ordering information

Supplies .....	214
Memory .....	214
Cable and interface accessories .....	214
Paper-handling accessories .....	214
User-replaceable parts .....	215

## Appendix B Service and support

Hewlett-Packard limited warranty statement .....	217
Customer self repair warranty service .....	218
Print cartridge limited warranty statement .....	219
HP Customer Care .....	220
Online Services .....	220
Telephone support .....	220
Software utilities, drivers, and electronic information .....	220
HP direct ordering for accessories or supplies .....	220
HP service information .....	220
HP service agreements .....	220
HP ToolboxFX .....	221
HP support and information for Macintosh computers .....	221
HP maintenance agreements .....	221
On-site service agreements .....	221
Repacking the device .....	221
Extended warranty .....	222

## Appendix C Specifications

Physical specifications .....	224
Electrical specifications .....	224
Power consumption .....	224

Environmental specifications .....	225
Acoustic emissions .....	225

**Appendix D Regulatory information**

FCC compliance .....	228
Environmental product stewardship program .....	229
Protecting the environment .....	229
Ozone production .....	229
Power consumption .....	229
Toner consumption .....	229
Paper use .....	229
Plastics .....	229
HP LaserJet print supplies .....	229
Return and recycling instructions .....	230
Paper .....	230
Material restrictions .....	230
Disposal of waste equipment by users in private households in the European Union ...	231
Material Safety Data Sheet (MSDS) .....	231
For more information .....	232
Telephone Consumer Protection Act (United States) .....	233
IC CS-03 requirements .....	233
EU statement for telecom operation .....	234
New Zealand telecom statements .....	234
Declaration of conformity .....	235
Safety statements .....	236
Laser safety .....	236
Canadian DOC regulations .....	236
EMI statement (Korea) .....	236
Laser statement for Finland .....	237
Substances table (China) .....	237

<b>Glossary .....</b>	<b>239</b>
-----------------------	------------

<b>Index .....</b>	<b>243</b>
--------------------	------------



---

# 1 Product basics

- [Product comparison](#)
- [Product features](#)
- [Product walkaround](#)
- [Supported operating systems](#)
- [Supported product software](#)

# Product comparison

The product is available in the following configurations.

---

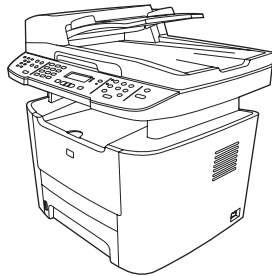

## HP LaserJet M2727nf mfp

- Prints letter-size pages at speeds up to 27 pages per minute (ppm) and A4-size pages at speeds up to 26 ppm.
- PCL 5 and PCL 6 printer drivers and HP postscript level 3 emulation.
- Tray 1 holds up to 50 sheets of print media or up to 5 envelopes.
- Tray 2 holds up to 250 sheets of print media.
- Optional 250-sheet input tray (tray 3) available.
- Automatic two-sided (duplex) printing, fax receiving, and copying.
- Average yield for the standard black print cartridge is 3,000 pages in accordance with ISO/IEC 19752. Actual yield depends on specific use.
- Average yield for the high-capacity print cartridge is 7,000 pages in accordance with ISO/IEC 19752. Actual yield depends on specific use.
- Hi-Speed USB 2.0 port and 10/100 Base-T network port.
- V.34 fax modem and 8-megabyte (MB) flash fax-storage memory.
- Two RJ-11 fax phone line ports
- 64-MB random-access memory (RAM).
- Flatbed scanner and 50-page automatic document feeder (ADF).
- One available DIMM slot for memory expansion (up to 320 MB).



## HP LaserJet M2727nfs mfp

HP LaserJet M2727nf mfp, plus:

- Additional 250-sheet input tray (tray 3) included.
  - Convenience stapler.
-

# Product features

---

<b>Performance</b>	<ul style="list-style-type: none"><li>● Prints up to 27 ppm (letter) or 26 ppm (A4).</li></ul>
<b>Print quality</b>	<ul style="list-style-type: none"><li>● 1,200 dots per inch (dpi) with Image REt 2400 text and graphics.</li><li>● Adjustable settings to optimize print quality.</li><li>● The HP UltraPrecise print cartridge has a finer toner formulation that provides sharper text and graphics.</li></ul>
<b>Fax</b>	<ul style="list-style-type: none"><li>● Full-functionality fax capabilities with a V.34 fax; includes a phone book, fax/tel, and delayed-fax features.</li></ul>
<b>Copy</b>	<ul style="list-style-type: none"><li>● Includes ADF that allows faster, more efficient copy jobs with multiple-page documents.</li></ul>
<b>Scan</b>	<ul style="list-style-type: none"><li>● The product provides 1,200 pixels per inch (ppi), 24-bit full-color scanning from letter/A4-size scanner glass.</li><li>● The product provides 300 ppi, 24-bit full-color scanning from the automatic document feeder (ADF).</li><li>● Includes an ADF that allows faster, more efficient scan jobs with multiple-page documents.</li></ul>
<b>Staple</b>	<ul style="list-style-type: none"><li>● The HP LaserJet M2727nfs includes a convenience stapler for fast and convenient stapling of up to 20 sheets of 80 g/m<sup>2</sup> or 20 lb media at the product.</li><li>● Large-capacity replaceable staple cassette holds 1,500 staples.</li></ul>
<b>Networking</b>	<ul style="list-style-type: none"><li>● TCP/IP<ul style="list-style-type: none"><li>○ IPv4</li><li>○ IPv6</li></ul></li></ul>
<b>Printer driver features</b>	<ul style="list-style-type: none"><li>● Fast printing performance, built-in Intellifont and TrueType scaling technologies, and advanced imaging capabilities are benefits of the PCL 6 printer language.</li></ul>
<b>Interface connections</b>	<ul style="list-style-type: none"><li>● Hi-Speed USB 2.0 port.</li><li>● 10/100 Base-T ethernet network port (RJ-45).</li><li>● RJ-11 fax/phone cable ports.</li></ul>
<b>Economical printing</b>	<ul style="list-style-type: none"><li>● N-up printing (printing more than one page on a sheet).</li><li>● Two-sided printing using the automatic duplexer.</li><li>● EconoMode setting.</li></ul>
<b>Supplies</b>	<ul style="list-style-type: none"><li>● A supplies status page that displays the amount of life remaining in the print cartridge.</li><li>● Authentication for HP print cartridges.</li><li>● Enabled supplies-ordering capability.</li></ul>
<b>Accessibility</b>	<ul style="list-style-type: none"><li>● Online user guide that is compatible with text screen-readers.</li><li>● Print cartridges can be installed and removed by using one hand.</li><li>● All doors and covers can be opened by using one hand.</li></ul>

---

# Product walkaround

## Front view

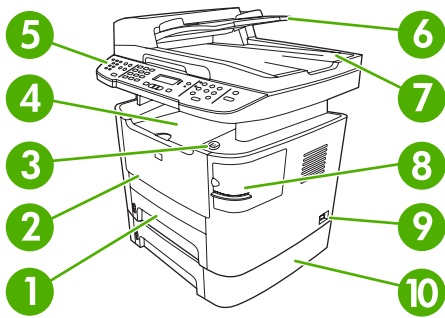

1	Tray 2
2	Tray 1
3	Print-cartridge door latch
4	Top (face-down) output bin
5	Control panel
6	Automatic document feeder (ADF) input tray
7	Automatic document feeder (ADF) output bin
8	Convenience stapler (HP LaserJet M2727nfs mfp only)
9	Power switch
10	Optional tray 3 (standard on the HP LaserJet M2727nfs mfp)

## Back view

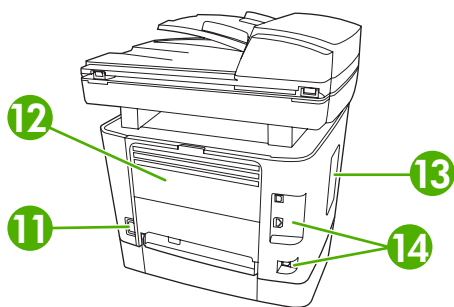

11	Power connector
12	Rear output door (face-up output bin for the straight-through output path)
13	DIMM door
14	Interface ports



## Interface ports

The product has a 10/100 Base-T (RJ-45) network port, a Hi-Speed USB 2.0 port, and fax ports.

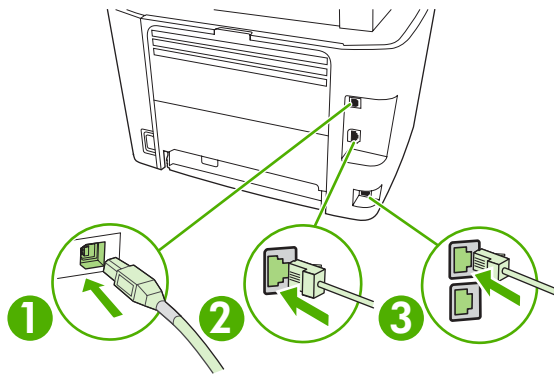

- |   |                       |
|---|-----------------------|
| 1 | Hi-Speed USB 2.0 port |
| 2 | Network port          |
| 3 | Fax ports             |

## Serial number and model number location

The serial number and product model number label is on the rear output bin door at the back of the product.

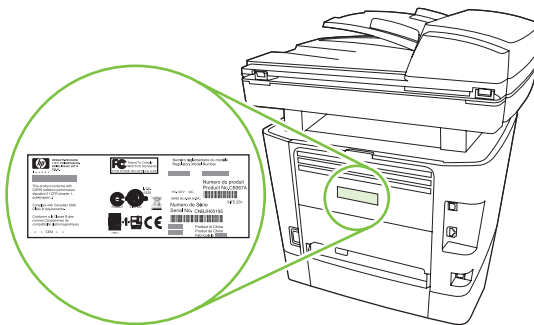

# Supported operating systems

The product supports the following operating systems:

## Full software installation

- Windows XP (32-bit and 64-bit)
- Windows Vista (32-bit and 64-bit)
- Mac OS X v10.3, v10.4, and later

## Print and scan driver

- Windows 2000
- Windows 2003 Server (32-bit and 64-bit)

## Printer driver only

- Linux (Web only)
- UNIX model scripts (Web only)

---

 **NOTE:** For Mac OS X v10.4 and later, PPC and Intel Core Processor Macs are supported.

---

# Supported product software

## Software included with the product

There are several options for completing a recommended install. Easy Install will complete the installation with default settings. Advanced Install allows you to select custom settings and choose the components that are installed.

## Recommended installation for Windows

- HP drivers
  - PCL 6 printer driver
  - Scan driver
- HP MFP software
  - HP ToolboxFX
  - HP LaserJet Scan program
  - HP Send Fax program and driver
  - HP Fax Setup Wizard
  - Uninstall program
- HP Update program
- HP Customer Participation Program
- Shop for HP Supplies program
- Other programs
  - Readiris OCR (not installed with other software; separate installation is required)

## Express installation (USB or network)

The following software is included with an Express installation:

- PCL 6 printer driver
- HP LaserJet Scan program and driver

---

 **NOTE:** Express installation supports faxing by using the control panel.

**NOTE:** PCL 5 and HP postscript level 3 emulation drivers can be installed using the Microsoft Add Printer wizard.

---

## Macintosh software

- HP Product Setup Assistant
- HP Device Configuration
- HP Uninstaller
- HP LaserJet software
  - HP Scan
  - HP Director
  - Fax program
  - Scan to e-mail program
  - HP Photosmart

## Supported printer drivers

Operating system	PCL 5	PCL 6	HP postscript level 3 emulation
Windows	✓ <sup>1</sup>	✓	✓ <sup>1</sup>
Mac OS X v10.3, v10.4, and later			✓
Linux <sup>2</sup>			✓

<sup>1</sup> Driver can be installed by using the Microsoft Add Printer wizard, too.

<sup>2</sup> For Linux, download the HP postscript level 3 emulation driver from [www.hp.com/go/linuxprinting](http://www.hp.com/go/linuxprinting).

The printer drivers include online Help that has instructions for common printing tasks and also describes the buttons, checkboxes, and drop-down lists that are in the printer driver.



---

## 2 Control panel

- [Control-panel walkaround](#)
- [Control-panel menus](#)

# Control-panel walkaround

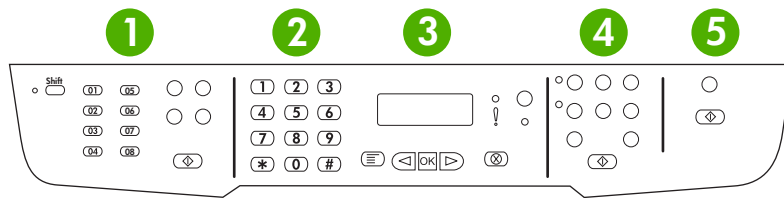

- 1 Fax controls.** Use the fax controls to change commonly used fax settings.
- 2 Alphanumeric buttons.** Use the alphanumeric buttons to type data into the product control-panel display and dial telephone numbers for faxing.
- 3 Setup and cancel controls.** Use these controls to select menu options, determine the product status, and cancel the current job.
- 4 Copy controls.** Use these controls to change commonly used default settings and to start copying.
- 5 Scan controls.** Use these controls to scan to e-mail or to a folder.

# Control-panel menus

## Use the control-panel menus

To gain access to the control-panel menus, use the following steps.

1. Press **Setup**.
2. Use the arrow buttons to navigate the listings.
  - Press **OK** to select the appropriate option.
  - Press **Cancel** to cancel an action or return to the Ready state.

## Control-panel main menus

These menus are available from the control-panel main menu:

- Use the **Fax Job status** menu to display a list of all faxes that are waiting to be sent, or have been received but are waiting to be printed, forwarded, or uploaded to the computer.
- Use the **Fax functions** menu to configure fax functions such as scheduling a delayed fax, cancelling the **Receive to PC** mode, reprinting faxes that were previously printed, or printing faxes that are stored in memory.
- Use the **Copy setup** menu to configure basic copy default settings such as contrast, collation, or the number of copies printed.
- Use the **Reports** menu to print reports that provide information about the product.
- Use the **Fax setup** menu to configure the fax phone book, the outgoing and incoming fax options, and the basic settings for all faxes.
- Use the **System setup** menu to establish basic product settings such as language, print quality, or volume levels.
- Use the **Network config** menu to configure network settings such as TCP/IP configuration.
- Use the **Service** menu to restore default settings, clean the product, and activate special modes that affect print output.

 **NOTE:** To print a detailed list of the entire control-panel menu and its structure, print a menu map. See [Information pages on page 142](#).

**Table 2-1 Fax Job status menu**

Menu item	Description
Fax Job status	Displays pending fax jobs, and allows you to cancel pending fax jobs.

**Table 2-2 Fax functions menu**

Menu item	Description
Send fax later	Allows a fax to be sent at a later time and date.
Stop Recv to PC	Disables the <b>Receive to PC</b> setting that allows a computer to upload all current faxes that have not been printed and all future faxes received by the product.

**Table 2-2 Fax functions menu (continued)**

Menu item	Description
Reprint last	Reprints the faxes that are stored in the product memory.
Polling receive	Allows the product to call another fax machine that has polling send enabled.
Clear saved faxes	Clears all faxes in the product memory.

**Table 2-3 Copy setup menu**

Menu item	Sub-menu item	Description
<b>Default Quality</b>	<b>Mixed</b>	Sets the default copy quality.
	<b>Picture</b>	
	<b>Film photo</b>	
	<b>Text</b>	
<b>Def. light/dark</b>		Sets the default contrast option.
<b>Def. Collation</b>	<b>On</b>	Sets the default collation option.
	<b>Off</b>	
<b>Def. # of copies</b>	(Range: 1-99)	Sets the default number of copies.
<b>Def. Reduce/Enlrg</b>	<b>Original=100%</b>	Sets the default percentage to reduce or enlarge a copied document.
	<b>Lgl-&gt;Ltr=78%</b>	
	<b>Lgl-&gt;A4=83%</b>	
	<b>A4-&gt;Ltr=94%</b>	
	<b>Ltr-&gt;A4=97%</b>	
	<b>Full Page=91%</b>	
	<b>Fit to page</b>	
	<b>2 pages/sheet</b>	
<b>Def. Tray Select</b>	<b>Auto select</b>	Sets the default input paper tray.
	<b>Tray 1</b>	
	<b>Tray 2</b>	
	<b>Tray 3 (if the tray is installed)</b>	
<b>Default 2-sided</b>	<b>1 to 1 sided</b>	Sets the default input scan format and the default output format. Two-sided printing is supported from the ADF only.
	<b>1 to 2 sided</b>	
	<b>2 to 2 sided</b>	
	<b>2 to 1 sided</b>	
<b>Def. Copy Draft</b>	<b>On</b>	Sets the default draft mode option.



**Table 2-3 Copy setup menu (continued)**

Menu item	Sub-menu item	Description
	Off	
Def. Multi-page	On	Sets the default multi-page flatbed copy option.
	Off	
Restore defaults		Sets all customized copy settings to the factory default values.

**Table 2-4 Reports menu**

Menu Item	Sub-menu item	Sub-menu item	Description
Demo page			Prints a page that demonstrates print quality.
Fax Reports	Fax Confirmation	Never Every fax Send fax only Receive fax	Sets whether or not the product prints a confirmation report after a successful sending or receiving job.
	Include 1st page	On Off	Sets whether or not the product includes a thumbnail image of the first page of the fax on the report.
	Fax Error Report	Every error Send Error Receive Error Never	Sets whether or not the product prints a report after a failed sending or receiving job.
	Last Call Report		Prints a detailed report of the last fax operation, either sent or received.
	Fax Activity log	Print log now Auto Log Print	<b>Print log now:</b> Prints a list of the faxes that have been sent from or received by this product. <b>Auto Log Print:</b> Select <b>On</b> to automatically print a report after every fax job. Select <b>Off</b> to turn off the automatic print feature.
	PhoneBook report		Prints a list of the speed dials that have been set up for this product.
	Block Fax list		Prints a list of phone numbers that are blocked from sending faxes to this product.
	Billing report		Prints a list of billing codes that have been used for outgoing faxes. This report shows how many sent faxes were billed to each code. This menu item appears only when the billing codes feature is turned on.
	All fax reports		Prints all fax-related reports.
Menu structure			Prints a control-panel menu layout map. The active settings for each menu are listed.
Config report			Prints a list of all the product settings. Includes network information when the product is connected to the network.

**Table 2-4 Reports menu (continued)**

Menu Item	Sub-menu item	Sub-menu item	Description
<b>Supplies status</b>			Prints the print-cartridge status. Includes the following information: <ul style="list-style-type: none"> <li>• Estimated pages remaining</li> <li>• Serial number</li> <li>• Number of pages printed</li> </ul>
<b>Network report</b>			Displays status for: <ul style="list-style-type: none"> <li>• Network hardware configuration</li> <li>• Enabled features</li> <li>• TCP/IP and SNMP information</li> <li>• Network statistics</li> </ul>
<b>Usage page</b>			Displays the number of pages printed, faxed, copied, and scanned by the product.
<b>PCL font list</b>			Prints a list of all installed PCL 5 fonts.
<b>PS font list</b>			Prints a list of all installed PS fonts.
<b>PCL6 font list</b>			Prints a list of all installed PCL 6 fonts.
<b>Service page</b>			Displays supported paper types, copy settings, and miscellaneous product settings.

**Table 2-5 Fax setup menu**

Menu Item	Sub-menu item	Sub-menu item	Description
<b>Fax Header</b>	<b>Your fax number</b>		Sets the identifying information that is sent to the receiving product.
	<b>Company name</b>		
<b>Phone Book</b>	<b>Individual setup</b>	<b>Add/Edit</b>	Edits the fax phone book speed dials and group-dial entries. The product supports up to 120 phone book entries, which can be either individual or group entries.
		<b>Delete</b>	
	<b>Group setup</b>	<b>Add/Edit group</b>	
		<b>Delete group</b>	
		<b>Del. # in group</b>	
<b>Delete all</b>			

**Table 2-5 Fax setup menu (continued)**

<b>Menu Item</b>	<b>Sub-menu item</b>	<b>Sub-menu item</b>	<b>Description</b>
<b>Fax Send setup</b>	<b>Def. Resolution</b>	<b>Fine</b>	Sets the resolution for sent documents. Higher resolution images have more dots per inch (dpi), so they show more detail. Lower resolution images have fewer dots per inch and show less detail, but the file size is smaller.
		<b>Superfine</b>	
		<b>Photo</b>	
		<b>Standard</b>	
	<b>Def. light/dark</b>		Sets the darkness of outgoing faxes.
	<b>Def. glass size</b>	<b>Letter</b>	Sets the default paper size for documents being scanned from the flatbed scanner.
		<b>A4</b>	
	<b>Dialing Mode</b>	<b>Tone</b>	Sets whether the product should use tone or pulse dialing.
		<b>Pulse</b>	
	<b>Redial if busy</b>	<b>On</b>	Sets whether or not the product should attempt to redial if the line is busy.
		<b>Off</b>	
	<b>Redial-no answer</b>	<b>On</b>	Sets whether the product should attempt to dial if the recipient fax number does not answer.
		<b>Off</b>	
<b>Redial Comm Err.</b>	<b>On</b>	Sets whether the product should attempt to redial the recipient fax number if a communication error occurs.	
	<b>Off</b>		
<b>Dial Prefix</b>	<b>On</b>	Specifies a prefix number that must be dialed when sending faxes from the product.	
	<b>Off</b>		
<b>Detect dial tone</b>	<b>On</b>	Sets whether the product should check for a dial tone before sending a fax.	
	<b>Off</b>		
<b>Billing codes</b>	<b>On</b>	Enables the use of billing codes when set to <b>On</b> . A prompt will appear that asks you to enter the billing code for an outgoing fax.	
	<b>Off</b>		

**Table 2-5 Fax setup menu (continued)**

Menu Item	Sub-menu item	Sub-menu item	Description
Fax Recv. setup	Answer mode	Automatic	<p>Sets the type of answer mode. The following options are available:</p> <ul style="list-style-type: none"> <li>● <b>Automatic:</b> The product automatically answers an incoming call on the configured number of rings.</li> <li>● <b>TAM:</b> A telephone answering machine (TAM) is attached to the Aux phone port of the product. The product will not pick up any incoming call, but only listen for fax tones after the answering machine has picked up the call.</li> <li>● <b>Fax/Tel:</b> The product must automatically pick up the call and determine if the call is a voice or fax call. If the call is a fax call, the product handles the call as usual. If the call is a voice call, an audible synthesized ring is generated to alert the user of an incoming voice call.</li> <li>● <b>Manual :</b> The user must press the <b>Start Fax</b> button or use an extension phone to make the product answer the incoming call.</li> </ul>
		TAM	
		Fax/Tel	
		Manual	
	Rings to answer	(Range of 1-9)	Sets the number of rings that must occur before the fax modem answers.
	Answer Ring Type	All Rings	<p>Allows a user to have two or three phone numbers on a single line, each with a different ring pattern (on a phone system with distinctive-ring service).</p> <ul style="list-style-type: none"> <li>● <b>All Rings:</b> The product answers any calls that come through the telephone line.</li> <li>● <b>Single:</b> The product answers any calls that produce a single-ring pattern.</li> <li>● <b>Double:</b> The product answers any calls that produce a double-ring pattern.</li> <li>● <b>Triple:</b> The product answers any calls that produce a triple-ring pattern.</li> <li>● <b>Double&amp;Triple:</b> The product answers any calls that produce a double-ring or triple-ring pattern.</li> </ul>
Single			
Double			
Triple			
		Double&Triple	
	Extension Phone	On	When this feature is enabled, the user can press the <b>1-2-3</b> buttons on the extension phone to cause the product to answer an incoming fax call.
		Off	
	Silence Detect	On	Sets whether the product can receive faxes from older model fax machines that do not emit the initial fax tones used during fax transmission.
		Off	
	Fit to page	On	Shrinks faxes that are larger than Letter-size or A4-size so that they can fit onto a Letter-size or A4-size page. If this feature is set to <b>Off</b> , faxes larger than Letter or A4 will print on multiple pages.
		Off	
	Stamp faxes	On	Sets product to add the date, time, sender's phone number, and page number to each page of the faxes that this product receives.
		Off	
	Forward fax	On	Sets product to send all received faxes to another fax machine.
		Off	

**Table 2-5 Fax setup menu (continued)**

Menu Item	Sub-menu item	Sub-menu item	Description
	<b>Block faxes</b>	<b>Add entry</b> <b>Delete entry</b> <b>Clear all</b>	Modifies the blocked fax list. The blocked fax list can contain up to 30 numbers. When the product receives a call from one of the blocked fax numbers, it deletes the incoming fax. It also logs the blocked fax in the activity log along with job-accounting information.
	<b>Private receive</b>	<b>On</b> <b>Off</b>	Setting <b>Private receive</b> to <b>On</b> requires the user to have set a password in product security. After the password is set, the following options are set: <ul style="list-style-type: none"> <li>• <b>Private receive</b> is turned on.</li> <li>• All old faxes are deleted from memory.</li> <li>• <b>Fax forwarding</b> or <b>Receive to PC</b> are set to <b>On</b> and are not allowed to be set.</li> <li>• All incoming faxes are stored in memory.</li> </ul>
		<b>Print faxes</b>	Prints stored faxes when the private-receive feature is on. This menu item appears only when the private-receive feature is turned on.
	<b>Reprint faxes</b>	<b>On</b> <b>Off</b>	Sets whether all received faxes stored in available memory can be reprinted.
	<b>F/T ring time</b>	<b>20</b> <b>30</b> <b>40</b> <b>70</b>	Sets when the product should stop sounding the <b>Fax/Tel</b> audible ring to notify the user of an incoming voice call.
	<b>Print duplex</b>	<b>On</b> <b>Off</b>	Sets whether all received faxes are printed using both sides of the paper.
<b>All faxes</b>	<b>Error correction</b>	<b>On</b> <b>Off</b>	Sets whether the product sends or receives the error portion again when a fax transmission error occurs.
	<b>Fax Speed</b>	<b>Fast(V.34)</b> <b>Medium(V.17)</b> <b>Slow(V.29)</b>	Increases or decreases the allowed fax communication speed.

**Table 2-6 System setup menu**

Menu Item	Sub-menu item	Sub-menu item	Description
<b>Language</b>	(List of available control-panel display languages.)		Sets the language in which the control panel displays messages and product reports.

**Table 2-6 System setup menu (continued)**

Menu Item	Sub-menu item	Sub-menu item	Description
Paper setup	Def. paper size	Letter	Sets the size for printing internal reports or any print job that does not specify a size.
		A4	
		Legal	
	Def. paper type	Lists available media types.	Sets the type for printing internal reports or any print job that does not specify a type.
	Tray 1	Paper type	Sets the default size and type for tray 1.
	Tray 2	Paper size	Sets the default size and type for tray 2.
Tray 3		Sets the default size and type for optional tray 3. This menu item appears only if tray 3 is installed.	
Paper out action	Wait forever	Cancel	<p>Determines how the product reacts when a print job requires a media size or type that is unavailable or when a specified tray is empty.</p> <ul style="list-style-type: none"> <li>• Select <b>Wait forever</b> to make the product wait until the correct media is loaded.</li> <li>• Select <b>Override</b> to print on a different size paper after a specified delay.</li> <li>• Select <b>Cancel</b> to automatically cancel the print job after a specified delay.</li> <li>• If either <b>Override</b> or <b>Cancel</b> is chosen, the control panel prompts for the number of seconds to delay. Use the arrow keys to either decrease the time or increase the time up to 3600 seconds.</li> </ul>
		Override	
Print quality	Cartridge low	(Range of 1-20)	Sets the percentage at which the control panel generates a low-toner message.
Replace supplies	Stop at Out		Sets how the product reacts when it detects that the print cartridge is out.
	Override out		
Print Density	(Range of 1-5)		Sets how much toner the product should apply to thicken lines and edges.
Volume settings	Alarm volume	Soft	Sets the volume levels for the product.
	Ring volume	Medium	
	Key-press volume	Loud	
	Phoneline volume	Off	
Time/Date	(Settings for time format, current time, date format, and current date.)		Sets the time and date setting for the product.
Product security	On		Sets the product-security feature. When the setting is set to <b>On</b> , you must set a personal identification number (PIN).
	Off		
Courier font	Regular		Sets Courier font values.
	Dark		

**Table 2-7 Service menu**

Menu item	Sub-menu item	Description
Print T.30 trace	Never	Prints or schedules a report that is used to troubleshoot fax transmission issues.
	If error	
	At end of call	
	Now	
Cleaning mode		Cleans the product when specks or other marks appear on printed output. The cleaning process removes dust and excess toner from the paper path.
		When selected, the product prompts you to load plain Letter or A4 paper in tray 1. Press <b>OK</b> to begin the cleaning process. Wait until the process completes. Discard the page that prints.
USB speed	High	Sets the USB speed.
	Full	
Less paper curl	On	When printed pages are consistently curled, this option sets the product to a mode that reduces curl.
	Off	
		The default setting is <b>Off</b> .
Archive print	On	When printing pages that will be stored for a long time, this option sets the product to a mode that reduces toner smearing and dusting.
	Off	
		The default setting is <b>Off</b> .
Restore defaults		Sets all customized settings to the factory default values.

**Table 2-8 Network config menu**

Menu item	Sub-menu item	Description
TCP/IP config	Automatic	<b>Automatic</b> automatically configures all the TCP/IP settings via DHCP, BootP or AutoIP.
	Manual	
		<b>Manual</b> requires you to manually configure the IP address, subnet mask, and default gateway.
		The control panel prompts you to specify values for each address section. Use the arrow buttons to increase or decrease the value. Press <b>OK</b> to accept the value and move the cursor to the next field.
		As each address is completed, the product prompts for address confirmation before moving to the next one. After all three addresses are set, the product automatically restarts.
Link speed	Automatic	Sets the link speed manually if needed.
	10T Full	After setting the link speed, the product automatically restarts.
	10T Half	
	100TX Full	
	100TX Half	
Auto crossover	On	Sets the auto crossover function.

**Table 2-8 Network config menu (continued)**

Menu item	Sub-menu item	Description
	Off	
<b>Network services</b>	IPv4	Sets whether the product will use either IPv4 or IPv6 protocol.
	IPv6	
<b>Show IP Address</b>	Yes	Sets whether the product displays the IP address on the control panel.
	No	
<b>Restore defaults</b>		Resets all network configurations to their factory defaults.



---

## 3 Software for Windows

- [Supported operating systems for Windows](#)
- [Supported printer drivers for Windows](#)
- [Select the correct printer driver for Windows](#)
- [Priority for print settings](#)
- [Change printer-driver settings for Windows](#)
- [Software installation types for Windows](#)
- [Remove software for Windows](#)
- [Supported utilities for Windows](#)
- [Software for other operating systems](#)

## Supported operating systems for Windows

The product supports the following Windows operating systems:

### Full software installation

- Windows XP (32-bit and 64-bit)
- Windows Vista (32-bit and 64-bit)

### Print and scan driver

- Windows 2000
- Windows 2003 Server (32-bit and 64-bit)

## Supported printer drivers for Windows

- PCL 5
- PCL 6
- PS level 3 emulation

The printer drivers include online Help that has instructions for common printing tasks and also describes the buttons, checkboxes, and drop-down lists that are in the printer driver.

## Select the correct printer driver for Windows

Printer drivers allow you to gain access to the device features and allow the computer to communicate with the device (using a printer language). Check the installation notes and readme files on the device CD for additional software and languages.

- Use the PCL 6 printer driver for the best overall performance.
- Use the PCL 5 printer driver for general office printing.
- Use the HP postscript level 3 emulation driver for printing from postscript level 3 emulation needs, or for postscript flash font support.

# Priority for print settings

Changes to print settings are prioritized depending on where the changes are made:

 **NOTE:** The names of commands and dialog boxes might vary depending on your software program.

- **Page Setup dialog box:** Click **Page Setup** or a similar command on the **File** menu of the program you are working in to open this dialog box. Settings changed here override settings changed anywhere else.
- **Print dialog box:** Click **Print**, **Print Setup**, or a similar command on the **File** menu of the program you are working in to open this dialog box. Settings changed in the **Print** dialog box have a lower priority and do *not* override changes made in the **Page Setup** dialog box.
- **Printer Properties dialog box (printer driver):** Click **Properties** in the **Print** dialog box to open the printer driver. Settings changed in the **Printer Properties** dialog box do not override settings anywhere else in the printing software.
- **Default printer driver settings:** The default printer driver settings determine the settings used in all print jobs, *unless* settings are changed in the **Page Setup**, **Print**, or **Printer Properties** dialog boxes.
- **Printer control panel settings:** Settings changed at the printer control panel have a lower priority than changes made anywhere else.

## Change printer-driver settings for Windows

To change the settings for all print jobs until the software program is closed	To change the default settings for all print jobs	To change the device configuration settings
<ol style="list-style-type: none"><li>1. On the <b>File</b> menu in the software program, click <b>Print</b>.</li><li>2. Select the driver, and then click <b>Properties</b> or <b>Preferences</b>.</li></ol> <p>The steps can vary; this procedure is most common.</p>	<ol style="list-style-type: none"><li>1. Click <b>Start</b>, click <b>Settings</b>, and then click <b>Printers</b> (Windows 2000) or <b>Printers and Faxes</b> (Windows XP Professional and Server 2003) or <b>Printers and Other Hardware Devices</b> (Windows XP Home).  For Windows Vista, click <b>Start</b>, click <b>Control Panel</b>, and then click <b>Printer</b>.</li><li>2. Right-click the driver icon, and then select <b>Printing Preferences</b>.</li></ol>	<ol style="list-style-type: none"><li>1. Click <b>Start</b>, click <b>Settings</b>, and then click <b>Printers</b> (Windows 2000) or <b>Printers and Faxes</b> (Windows XP Professional and Server 2003) or <b>Printers and Other Hardware Devices</b> (Windows XP Home).  For Windows Vista, click <b>Start</b>, click <b>Control Panel</b>, and then click <b>Printer</b>.</li><li>2. Right-click the driver icon, and then select <b>Properties</b>.</li><li>3. Click the <b>Device Settings</b> tab.</li></ol>

## Software installation types for Windows

The following software installation types are available:

- **Recommended.** Installs the full software solution.
- **Express.** Installs the printer drivers only. There is an express option for USB-connected products and another express option for network-connected products.
- **Custom.** Use the **Custom** installation to select which software and drivers to install.

## Remove software for Windows

1. Click **Start**, and then click **Programs** or **All Programs**.
2. Click **HP**, and then click **HP LaserJet M2727**.
3. Click **Uninstall**, and then follow the onscreen instructions to remove the software.

# Supported utilities for Windows

## HP ToolboxFX

The HP ToolboxFX is a program that you can use for the following tasks:

- Checking the device status
- Checking the supplies status
- Setting up alerts
- Viewing device documentation
- Gaining access to troubleshooting and maintenance tools

HP ToolboxFX is installed during the Recommended software installation from the product CD-ROM.

For more information, see [View HP ToolboxFX on page 144](#).

## Embedded Web server

The device is equipped with an embedded Web server, which provides access to information about device and network activities. This information appears in a Web browser, such as Microsoft Internet Explorer, Netscape Navigator, Apple Safari, or Firefox.

The embedded Web server resides on the device. It is not loaded on a network server.

The embedded Web server provides an interface to the device that anyone who has a network-connected computer and a standard Web browser can use. No special software is installed or configured, but you must have a supported Web browser on your computer. To gain access to the embedded Web server, type the IP address for the device in the address line of the browser. (To find the IP address, print a configuration page. For more information about printing a configuration page, see [Information pages on page 142](#).)

For a complete explanation of the features and functionality of the embedded Web server, see [Embedded Web server on page 153](#).

## HP Web Jetadmin

HP Web Jetadmin is a browser-based management tool for network-connected printers within an intranet, and it should be installed only on the network administrator's computer.

To download a current version of HP Web Jetadmin and for the latest list of supported host systems, visit [www.hp.com/go/webjetadmin](http://www.hp.com/go/webjetadmin).

When installed on a host server, a Windows client can gain access to HP Web Jetadmin by using a supported Web browser (such as Microsoft® Internet Explorer 4.x or Netscape Navigator 4.x or later) by navigating to the HP Web Jetadmin host.

## Other Windows components and utilities

- Software installer — automates the printing system installation
- Online Web registration

- HP Customer Participation Program
- HP Update

## Software for other operating systems

OS	Software
UNIX	For HP-UX and Solaris networks, go to <a href="http://www.hp.com/support/net_printing">www.hp.com/support/net_printing</a> to download the HP Jetdirect printer installer for UNIX.
Linux	For information, go to <a href="http://www.hp.com/go/linuxprinting">www.hp.com/go/linuxprinting</a> .

---

## 4 Use the product with Macintosh

- [Software for Macintosh](#)
- [Use features in the Macintosh printer driver](#)
- [Scan from the product and HP Director \(Macintosh\)](#)
- [Fax a document from a Macintosh computer](#)

# Software for Macintosh

## Supported operating systems for Macintosh

The device supports the following Macintosh operating systems:

- Mac OS X v10.3, v10.4 and later

---

 **NOTE:** For Mac OS v10.4 and later, PPC and Intel Core Processor Macs are supported.

---

## Supported printer drivers for Macintosh

The HP installer provides PostScript® Printer Description (PPD) files, Printer Dialog Extensions (PDEs), and the HP Printer Utility for use with Macintosh computers.

The PPDs, in combination with the Apple PostScript printer drivers, provide access to device features. Use the Apple PostScript printer driver that comes with the computer.

## Priority for print settings for Macintosh

Changes to print settings are prioritized depending on where the changes are made:

---

 **NOTE:** The names of commands and dialog boxes might vary depending on your software program.

---

- **Page Setup dialog box:** Click **Page Setup** or a similar command on the **File** menu of the program you are working in to open this dialog box. Settings changed here override settings changed anywhere else.
- **Print dialog box:** Click **Print**, **Print Setup**, or a similar command on the **File** menu of the program you are working in to open this dialog box. Settings changed in the **Print** dialog box have a lower priority and do *not* override changes made in the **Page Setup** dialog box.
- **Printer Properties dialog box (printer driver):** Click **Properties** in the **Print** dialog box to open the printer driver. Settings changed in the **Printer Properties** dialog box do not override settings anywhere else in the printing software.
- **Default printer driver settings:** The default printer driver settings determine the settings used in all print jobs, *unless* settings are changed in the **Page Setup**, **Print**, or **Printer Properties** dialog boxes.
- **Printer control panel settings:** Settings changed at the printer control panel have a lower priority than changes made anywhere else.

## Change printer-driver settings for Macintosh

---

**To change the settings for all print jobs until the software program is closed**

1. On the **File** menu, click **Print**.
2. Change the settings that you want on the various pop-up menus.

**To change the default settings for all print jobs**

1. On the **File** menu, click **Print**.
2. Change the settings that you want on the various pop-up menus.
3. On the **Presets** pop-up menu, click **Save as** and type a name for the preset.

**To change the device configuration settings**

1. In the Finder, on the **Go** menu, click **Applications**.
  2. Open **Utilities**, and then open **Printer Setup Utility**.
  3. Click on the print queue.
-



To change the settings for all print jobs until the software program is closed	To change the default settings for all print jobs	To change the device configuration settings
	<p>These settings are saved in the <b>Presets</b> menu. To use the new settings, you must select the saved preset option every time you open a program and print.</p>	<ol style="list-style-type: none"> <li>On the <b>Printers</b> menu, click <b>Show Info</b>.</li> <li>Click the <b>Installable Options</b> menu.</li> </ol>
		<p><b>NOTE:</b> Configuration settings might not be available in Classic mode.</p>

## Software installation types for Macintosh

### Install Macintosh software for direct connections (USB)

- Connect a USB cable between the device USB port and the computer USB port. Use a standard 2-meter (6.56-foot) USB cable.
- Insert the device CD into the CD-ROM drive and run the installer. If the CD menu does not run automatically, double-click the CD icon on the desktop.
- Double-click the **Installer** icon in the HP LaserJet Installer folder.
- Follow the instructions on the computer screen.

USB printer queues are created automatically when the device is attached to the computer. However, the queue will use a generic PPD if the installer has not been run before the USB cable is connected. Complete the following steps to change the queue PPD.

- On the computer hard drive, open **Applications**, open **Utilities**, and then open **Printer Setup Utility**.
- Select the correct printer queue, and then click **Show Info** to open the **Printer Info** dialog box.
- In the pop-up menu, select **Printer Model**, and then, in the pop-up menu in which **Generic** is selected, select the correct PPD for the device.
- Print a test page from any software program to make sure that the software is correctly installed.

If installation fails, reinstall the software. If this fails, see the installation notes or late-breaking readme files on the device CD or the flyer that came in the box for help.

### Install Macintosh software for networks

- Connect the network cable between the HP Jetdirect print server and a network port.
- Insert the CD into the CD-ROM drive. If the CD does not run automatically, double-click the CD icon on the desktop.
- Double-click the **Installer** icon in the HP LaserJet Installer folder.
- Follow the instructions on the computer screen.
- On the computer hard drive, open **Applications**, open **Utilities**, and then open **Printer Setup Utility**.

6. Click **Add Printer**.
7. Select **Rendezvous** or **Bonjour** as the connection type.



---

**NOTE:** Depending on product configuration, **Appletalk** or **IP Printing** might also be available.

---

8. Select the device from the list.
9. Click **Add Printer**.
10. Close the Print Center or the Printer Setup Utility.

## Remove software from Macintosh operating systems

To remove the software from a Macintosh computer, drag the PPD files to the trash can.

## Supported utilities for Macintosh

### Embedded Web server

The device is equipped with an embedded Web server, which provides access to information about device and network activities. This information appears in a Web browser, such as Microsoft Internet Explorer, Netscape Navigator, Apple Safari, or Firefox.

The embedded Web server resides on the device. It is not loaded on a network server.

The embedded Web server provides an interface to the device that anyone who has a network-connected computer and a standard Web browser can use. No special software is installed or configured, but you must have a supported Web browser on your computer. To gain access to the embedded Web server, type the IP address for the device in the address line of the browser. (To find the IP address, print a configuration page. For more information about printing a configuration page, see [Information pages on page 142.](#))

For a complete explanation of the features and functionality of the embedded Web server, see [Embedded Web server on page 153.](#)

### Macintosh Configure Device

Macintosh Configure Device is a Web-based program that provides access to information about the product (for example, information about supplies status and product settings). Use Macintosh Configure Device to monitor and manage the product from the computer



---

**NOTE:** You must perform a complete software installation to use Macintosh Configure Device.

---

- Check the product status and print information pages.
- Check and change product system settings.
- Check default print settings.
- Check and change fax settings, including fax send, fax receive, fax phone book and speed-dial settings, and fax reports.
- Check and change network settings, including IP configuration, Advanced, mDNS, SNMP, network configuration, and password.

You can view Macintosh Configure Device when the product is directly connected to your computer or when it is connected to the network.



---

**NOTE:** You do not have to have Internet access to open and use Macintosh Configure Device.

---

### View Macintosh Configure Device when the product is directly connected to the computer

1. Open HP Director by clicking the **HP Director** icon in the dock.
2. In HP Director, click **Settings**.
3. Select **Configure device** to open the Macintosh Configure Device home page in a browser.

### View Macintosh Configure Device when the product is connected to a network

1. Open one of the following supported Web browsers:
  - Safari 1.2 or later
  - Microsoft Internet Explorer 5.0 or later
  - Netscape Navigator 4.75 or later
  - Opera 6.05 or later
2. Enter the IP address of the product into the Web browser to open the Macintosh Configure Device home page.

# Use features in the Macintosh printer driver

## Print

### Create and use printing presets in Macintosh

Use printing presets to save the current printer driver settings for reuse.

#### Create a printing preset

1. On the **File** menu, click **Print**.
2. Select the driver.
3. Select the print settings.
4. In the **Presets** box, click **Save As...**, and type a name for the preset.
5. Click **OK**.

#### Use printing presets

1. On the **File** menu, click **Print**.
2. Select the driver.
3. In the **Presets** box, select the printing preset that you want to use.

---

 **NOTE:** To use printer-driver default settings, select **Factory Default**.

---

### Resize documents or print on a custom paper size

You can scale a document to fit on a different size of paper.

1. On the **File** menu, click **Print**.
2. Open the **Paper Handling** menu.
3. In the area for **Destination Paper Size**, select **Scale to fit paper size**, and then select the size from the drop-down list.
4. If you want to use only paper that is smaller than the document, select **Scale down only**.

### Print a cover page

You can print a separate cover page for your document that includes a message (such as “Confidential”).

1. On the **File** menu, click **Print**.
2. Select the driver.
3. Open the **Cover Page** pop-up menu, and then select whether to print the cover page **Before Document** or **After Document**.
4. In the **Cover Page Type** pop-up menu, select the message that you want to print on the cover page.

---

 **NOTE:** To print a blank cover page, select **Standard** as the **Cover Page Type**.

---

## Use watermarks

A watermark is a notice, such as “Confidential,” that is printed in the background of each page of a document.

1. On the **File** menu, click **Print**.
2. Open the **Watermarks** menu.
3. Next to **Mode**, select the type of watermark to use. Select **Watermark** to print a semi-transparent message. Select **Overlay** to print a message that is not transparent.
4. Next to **Pages**, select whether to print the watermark on all pages or on the first page only.
5. Next to **Text**, select one of the standard messages, or select **Custom** and type a new message in the box.
6. Select options for the remaining settings.

## Print multiple pages on one sheet of paper in Macintosh

You can print more than one page on a single sheet of paper. This feature provides a cost-effective way to print draft pages.

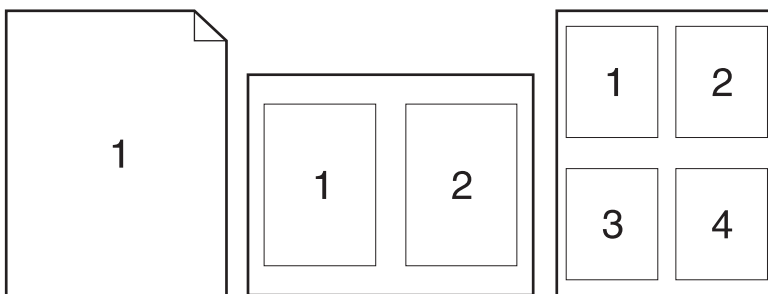

1. On the **File** menu, click **Print**.
2. Select the driver.
3. Open the **Layout** pop-up menu.
4. Next to **Pages per Sheet**, select the number of pages that you want to print on each sheet (1, 2, 4, 6, 9, or 16).
5. Next to **Layout Direction**, select the order and placement of the pages on the sheet.
6. Next to **Borders**, select the type of border to print around each page on the sheet.

## Print on both sides of the page (duplex printing)

### Use automatic duplex printing

1. Insert enough paper into one of the trays to accommodate the print job. If you are loading special paper such as letterhead, load it in one of the following ways:
  - For tray 1, load the letterhead paper face-up with the bottom edge feeding into the printer first.
  - For all other trays, load the letterhead paper face-down with the top edge at the back of the tray.
2. On the **File** menu, click **Print**.
3. Open the **Layout** pop-up menu.
4. Next to **Two-Sided**, select either **Long-Edge Binding** or **Short-Edge Binding**.
5. Click **Print**.

### Print on both sides manually

1. Insert enough paper into one of the trays to accommodate the print job. If you are loading special paper such as letterhead, load it in one of the following ways:
  - For tray 1, load the letterhead paper face-up with the bottom edge feeding into the printer first.
  - For all other trays, load the letterhead paper face-down with the top edge at the back of the tray.

---

△ **CAUTION:** To avoid jams, do not load paper that is heavier than 105 g/m<sup>2</sup> (28-lb bond).

---

2. On the **File** menu, click **Print**.
3. On the **Finishing** pop-up menu, select the **Manual Duplex** option.
4. Click **Print**. Follow the instructions in the pop-up window that appears on the computer screen before replacing the output stack in tray 1 for printing the second half.
5. Go to the printer, and remove any blank paper that is in tray 1.
6. Insert the printed stack face-up with the bottom edge feeding into the printer first in tray 1. You *must* print the second side from tray 1.
7. If prompted, press the appropriate control-panel button to continue.

### Use the Services menu

If the device is connected to a network, use the **Services** menu to obtain device and supply-status information.

1. On the **File** menu, click **Print**.
2. Open the **Services** menu.
3. Select a maintenance task from the drop-down list, and then click **Launch**. The embedded Web server opens to the page that provides the information for the task that you selected.
4. To go to various support Web sites for this device, select an Internet Services option from the drop-down list, and then click **Go!**.

# Scan from the product and HP Director (Macintosh)

For more information about tasks and settings described in this section, see the HP Director online Help.

## Scanning tasks

To scan to a software program, scan an item using the program itself. Any TWAIN-compliant program can scan an image. If the program is not TWAIN-compliant, save the scanned image to a file then place, open, or import the file in the software program.

### Use page-by-page scanning

1. Lift the flatbed scanner lid and load the original that is to be scanned face-down on the flatbed scanner with the upper-left corner of the document at the lower-right corner of the glass. Gently close the lid.
2. Double-click the HP Director desktop alias.
3. Click the HP Director, and then click **Scan** to open the **HP** dialog box.
4. Click **Scan**.
5. To scan multiple pages, load the next page and click **Scan**. Repeat until all pages are scanned.
6. Click **Finish**, and then click **Destinations**.

### Scan to file

1. In **Destinations**, choose **Save To File(s)**.
2. Name the file and specify the destination location.
3. Click **Save**. The original is scanned and saved.

### Scan to e-mail

1. In **Destinations**, choose **E-mail**.
2. A blank e-mail opens with the scanned document as an attachment.
3. Enter an e-mail recipient, add text, or other attachments, then click **Send**.

## Fax a document from a Macintosh computer

1. In the software program, on the **File** menu, select **Print**.
2. Click **PDF**, and then select **Fax PDF**.
3. Enter a fax number in the **To** field.
4. To include a fax cover page, select **Use Cover Page**, and then enter the cover page subject and message (optional).
5. Click **Fax**.



---

# 5 Connectivity

- [Connect the product directly to a computer with USB](#)
- [Printer sharing disclaimer](#)
- [Supported network operating systems](#)
- [Supported network protocols](#)
- [Install the product on a network](#)
- [Configure the network product](#)

---

 **NOTE:** Configuring TCP/IP settings is complicated and should be performed only by experienced network administrators. BOOTP will require a server to configure specific TCP/IP settings for the product. DHCP will also require a server, but the TCP/IP settings will not be fixed for the product. Finally, the manual method to configure specific TCP/IP settings can be done from the control panel, the embedded Web server, HP ToolboxFX, or HP Web Jetadmin. For additional help or network configuration, contact your network provider.

---

## Connect the product directly to a computer with USB

 **NOTE:** Do not connect the USB cable from the product to the computer until the installer prompts you to do so.

---

1. Insert the product CD into your computer. If the software installer does not start, navigate to the setup.exe file on the CD and double-click the file.
2. Follow the installer instructions.
3. Allow the installation process to complete, and then restart the computer.

## Printer sharing disclaimer

HP does not support peer-to-peer networking, as the feature is a function of Microsoft operating systems and not of the HP printer drivers. Go to Microsoft at [www.microsoft.com](http://www.microsoft.com).

## Supported network operating systems

The following operating systems support network printing:

### Full software installation

- Windows XP (32-bit and 64-bit)
- Windows Vista (32-bit and 64-bit)
- Mac OS X v10.3, v10.4, and later

### Print and scan driver

- Windows 2000
- Windows 2003 Server (32-bit and 64-bit)

### Printer driver only

- Linux (Web only)
- UNIX model scripts (Web only)

# Supported network protocols

The product supports the TCP/IP network protocol. It is the most widely used and accepted networking protocol. Many networking services utilize this protocol. This product also supports IPv4 and IPv6. The following tables list the networking services/protocols that are supported on the product.

**Table 5-1 Printing**

Service name	Description
port9100 (Direct Mode)	Printing service
Line printer daemon (LPD)	Printing service

**Table 5-2 Network product discovery**

Service name	Description
SLP (Service Location Protocol)	Device Discovery Protocol, used to help find and configure network devices. Used primarily by Microsoft-based software programs.
mDNS (multicast Domain Name Service - also known as "Rendezvous" or "Bonjour")	Device Discovery Protocol, used to help find and configure network devices. Used primarily by Apple Macintosh-based software programs.

**Table 5-3 Messaging and management**

Service name	Description
HTTP (hypertext transfer protocol)	Allows Web browsers to communicate with embedded Web server.
EWS (embedded Web server)	Allows a user to manage the product through a Web browser.
SNMP (simple network management protocol)	Used by network programs for product management. SNMP V1 and standard MIB-II (Management Information Base) objects are supported.

**Table 5-4 IP addressing**

Service name	Description
DHCP (dynamic host configuration protocol)	For Automatic IP address assignment. DHCP server provides the product with an IP address. Generally requires no user intervention for product to obtain IP address from a DHCP server.
BOOTP (bootstrap protocol)	For Automatic IP address assignment. BOOTP server provides the product with an IP address. Requires administrator to input the product MAC hardware address on BOOTP server in order for product to obtain an IP address from that server.
Auto IP	For Automatic IP address assignment. If neither a DHCP server nor a BOOTP server is present, this service allows the product to generate a unique IP address.

## Install the product on a network

In this configuration, the product is connected directly to the network and can be configured to allow all computers on the network to print directly to the product.

---

 **NOTE:** This mode is the recommended network configuration for the product.

---

1. Before turning on the product, connect the product directly to the network by inserting a network cable into the product network port.
2. Turn on the product, wait 2 minutes, and then use the control panel to print a configuration page. .

---

 **NOTE:** Make sure that an IP address is listed on the configuration page before proceeding to the next step. If an IP address is not present, reprint the configuration page.

---

3. Insert the product CD into the computer. If the software installer does not start, navigate to the setup.exe file on the CD and double-click the file.
4. Follow the installer instructions.

---

 **NOTE:** When the installer prompts for a network address, provide the IP address listed on the configuration page that you printed before starting the installer program, or search for the product on the network.

---

5. Allow the installation process to complete, and then restart the computer.

# Configure the network product

## View settings

### Network configuration page

The network configuration page lists the current settings and properties of the product network card. To print the network configuration page from the product, complete the following steps.

1. On the control panel, press **Setup**.
2. Use the arrow buttons to select **Reports**, and then press **OK**.
3. Use the arrow buttons to select **Network report**, and then press **OK**.

### Configuration page

The configuration page lists the current settings and properties of the product. You can print a configuration page from the product or HP ToolboxFX. To print the configuration page from the product, complete the following steps.

1. On the control panel, press **Setup**.
2. Use the arrow buttons to select **Reports**, and then press **OK**.
3. Use the arrow buttons to select **Config report**, and then press **OK**.

A second page also prints. On that page, the **Fax Settings** and **Imaging Settings** sections provide details about the product fax settings.

## Change settings

You can use the embedded Web server (EWS) or HP ToolboxFX to view or change the IP configuration settings. To gain access to the embedded Web server, type the product IP address in the address line of a Web browser.

You can view HP ToolboxFX when the product is directly connected to a computer or when it is connected to the network. You must perform a complete software installation to use HP ToolboxFX.

Open HP ToolboxFX in one of these ways:

- In the Windows system tray, double-click the HP ToolboxFX icon.
- On the Windows **Start** menu, click **Programs** (or **All Programs** in Windows XP), click **HP**, click the product name, and then click **HP ToolboxFX**.

In HP ToolboxFX, click the **Network Settings** tab.

From the **Networking** tab (EWS) or the **Network Settings** tab (HP ToolboxFX), you can change the following configurations:

- Host Name
- Manual IP Address
- Manual Subnet Mask
- Manual Default Gateway

---

 **NOTE:** Changing the network configuration might require you to change the browser URL before you can communicate with the product again. The product will be unavailable for a few seconds while the network resets.

---

## IP address

The product IP address can be set manually, or it can be configured automatically via DHCP, BootP, or AutoIP.

### Manual configuration

1. On the control panel, press **Setup**.
2. Use the arrow buttons to select **Network config**, and then press **OK**.
3. Use the arrow buttons to select **TCP/IP config**, and then press **OK**.
4. Use the arrow buttons to select **Manual**, and then press **OK**.
5. Use the alphanumeric buttons to type the IP address, and then press **OK**.
6. If the IP address is incorrect, use the arrow buttons to select **No**, and then press **OK**. Repeat step 5 with the correct IP address, and then repeat step 5 for the subnet mask and default gateway settings.

### Automatic configuration

1. On the control panel, press **Setup**.
2. Use the arrow buttons to select **Network config**, and then press **OK**.
3. Use the arrow buttons to select **TCP/IP config**, and then press **OK**.
4. Use the arrow buttons to select **Automatic**, and then press **OK**.

It may take several minutes before the automatic IP address is ready for use.

---

 **NOTE:** If you want to disable or enable specific automatic IP modes (such as BOOTP, DHCP, or AutoIP), these settings can be changed by using the embedded Web server or HP ToolboxFX only.

---

### IPv4 and IPv6 settings

Only the IPv4 protocol can be configured manually. The IPv4 protocol can be set from HP ToolboxFX or from the product control panel. The IPv6 protocol can be selected only from the product control panel.

### Link speed setting

---

 **NOTE:** Incorrect changes to the link speed setting might prevent the product from communicating with other network devices. For most situations, the product should be left in automatic mode. Changes can cause the product to power cycle. Changes should be made only while the product is idle.

---

1. On the control panel, press **Setup**.
2. Use the arrow buttons to select **Network config**, and then press **OK**.
3. Use the arrow buttons to select **Link speed**, and then press **OK**.

4. Use the arrow buttons to select one of the following settings.

- Automatic
- 10T Full
- 10T Half
- 100TX Full
- 100TX Half

---

 **NOTE:** The setting must match with the network product to which you are connecting (a network hub, switch, gateway, router, or computer).

---

5. Press **OK**. The product will power cycle.





---

## 6 Paper and print media

- [Understand paper and print media use](#)
- [Supported paper and print media sizes](#)
- [Special paper or print media guidelines](#)
- [Load paper and print media](#)
- [Configure trays](#)
- [Change tray selection](#)

## Understand paper and print media use

This product supports a variety of paper and other print media in accordance with the guidelines in this user guide. Paper or print media that does not meet these guidelines might cause the following problems:

- Poor print quality
- Increased jams
- Premature wear on the product, requiring repair

For best results, use only HP-brand paper and print media designed for laser printers or multiuse. Do not use paper or print media made for inkjet printers. Hewlett-Packard Company cannot recommend the use of other brands of media because HP cannot control their quality.

It is possible for paper to meet all of the guidelines in this user guide and still not produce satisfactory results. This might be the result of improper handling, unacceptable temperature and/or humidity levels, or other variables over which Hewlett-Packard has no control.

---

△ **CAUTION:** Using paper or print media that does not meet Hewlett-Packard's specifications might cause problems for the product, requiring repair. This repair is not covered by the Hewlett-Packard warranty or service agreements.

---

# Supported paper and print media sizes

This product supports a number of paper sizes, and it adapts to various media.

 **NOTE:** To obtain best print results, select the appropriate paper size and type in the print driver before printing.

**Table 6-1 Supported paper and print media sizes**

Size	Dimensions	Tray 1	Trays 2 and 3
Letter	216 x 279 mm (8.5 x 11 inches)	✓	✓
Legal	216 x 356 mm (8.5 x 14 inches)	✓	✓
A4	210 x 297 mm (8.27 x 11.69 inches)	✓	✓
Executive	184 x 267 mm (7.24 x 10.51 inches)	✓	✓
A3	297 x 420 mm (11.69 x 16.54 inches)		
A5	148 x 210 mm (5.83 x 8.27 inches)	✓	✓
A6	105 x 148 mm (4.13 x 5.83 inches)	✓	
B5 (JIS)	182 x 257 mm (7.17 x 10.12 inches)	✓	✓
16k	197 x 273 mm (7.75 x 10.75 inches)	✓	
16k	195 x 270 mm (7.7 x 10.6 inches)	✓	
16k	184 x 260 mm (7.25 x 10.25 inches)	✓	
8.5 x 13	216 x 330 mm (8.5 x 13 inches)	✓	✓
4 x 6 <sup>1</sup>	107 x 152 mm (4 x 6 inches)	✓	
5 x 8 <sup>1</sup>	127 x 203 mm (5 x 8 inches)	✓	
10 x 15 cm <sup>1</sup>	100 x 150 mm (3.9 x 5.9 inches)	✓	
Custom	<b>Tray 1:</b> Minimum—76 x 127 mm (3 x 5 inches); Maximum—216 x 356 mm (8.5 x 14 inches)	✓	
	<b>Trays 2 and 3:</b> Minimum—148 x 210 mm (5.8 x 8.3 inches); Maximum—216 x 356 mm (8.5 x 14 inches)		✓

<sup>1</sup> These sizes are supported as custom sizes.

**Table 6-2 Supported envelopes and postcards**

Size	Dimensions	Tray 1	Trays 2 and 3
Envelope #10	105 x 241 mm (4.13 x 9.49 inches)	✓	Not supported.

**Table 6-2 Supported envelopes and postcards (continued)**

Size	Dimensions	Tray 1	Trays 2 and 3
Envelope DL	110 x 220 mm (4.33 x 8.66 inches)	✓	Not supported.
Envelope C5	162 x 229 mm (6.93 x 9.84 inches)	✓	Not supported.
Envelope B5	176 x 250 mm (6.7 x 9.8 inches)	✓	Not supported.
Envelope Monarch	98 x 191 mm (3.9 x 7.5 inches)	✓	Not supported.
Postcard	100 x 148 mm (3.94 x 5.83 inches)	✓	Not supported.
Double postcard	148 x 200 mm (5.83 x 7.87 inches)	✓	Not supported.

## Special paper or print media guidelines

This product supports printing on special media. Use the following guidelines to obtain satisfactory results. When using special paper or print media, be sure to set the type and size in your print driver to obtain the best print results.

- △ **CAUTION:** HP LaserJet printers use fusers to bond dry toner particles to the paper in very precise dots. HP laser paper is designed to withstand this extreme heat. Using inkjet paper not designed for this technology could damage your printer.

Media type	Do	Do not
Envelopes	<ul style="list-style-type: none"> <li>• Store envelopes flat.</li> <li>• Use envelopes where the seam extends all the way to the corner of the envelope.</li> <li>• Use peel-off adhesive strips that are approved for use in laser printers.</li> </ul>	<ul style="list-style-type: none"> <li>• Do not use envelopes that are wrinkled, nicked, stuck together, or otherwise damaged.</li> <li>• Do not use envelopes that have clasps, snaps, windows, or coated linings.</li> <li>• Do not use self-stick adhesives or other synthetic materials.</li> </ul>
Labels	<ul style="list-style-type: none"> <li>• Use only labels that have no exposed backing between them.</li> <li>• Use Labels that lie flat.</li> <li>• Use only full sheets of labels.</li> </ul>	<ul style="list-style-type: none"> <li>• Do not use labels that have wrinkles or bubbles, or are damaged.</li> <li>• Do not print partial sheets of labels.</li> </ul>
Transparencies	<ul style="list-style-type: none"> <li>• Use only transparencies that are approved for use in laser printers.</li> <li>• Place transparencies on a flat surface after removing them from the product.</li> </ul>	<ul style="list-style-type: none"> <li>• Do not use transparent print media not approved for laser printers.</li> </ul>
Letterhead or preprinted forms	<ul style="list-style-type: none"> <li>• Use only letterhead or forms approved for use in laser printers.</li> </ul>	<ul style="list-style-type: none"> <li>• Do not use raised or metallic letterhead.</li> </ul>
Heavy paper	<ul style="list-style-type: none"> <li>• Use only heavy paper that is approved for use in laser printers and meets the weight specifications for this product.</li> </ul>	<ul style="list-style-type: none"> <li>• Do not use paper that is heavier than the recommended media specification for this product unless</li> </ul>

Media type	Do	Do not
Glossy or coated paper	<ul style="list-style-type: none"> <li>Use only glossy or coated paper that is approved for use in laser printers.</li> </ul>	<ul style="list-style-type: none"> <li>Do not use glossy or coated paper designed for use in inkjet products.</li> </ul>

## Load paper and print media

### Tray 1

Tray 1 is accessed from the front of the product. The product prints from tray 1 before attempting to print from other trays.

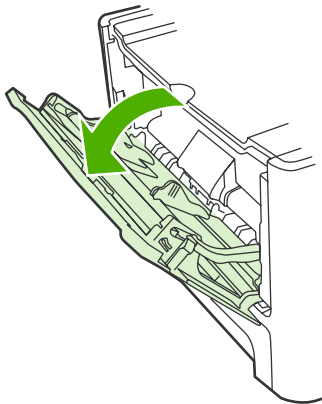

Tray 1 holds up to 50 sheets of 75 g/m<sup>2</sup> (20 lb) media or five envelopes, ten transparencies, or ten cards. You can use tray 1 to print the first page on media different from the remainder of the document.

Media guides ensure that the media is correctly fed into the product and that the print is not skewed (crooked on the media). When loading media, adjust the media guides to match the width of the media that you are using.

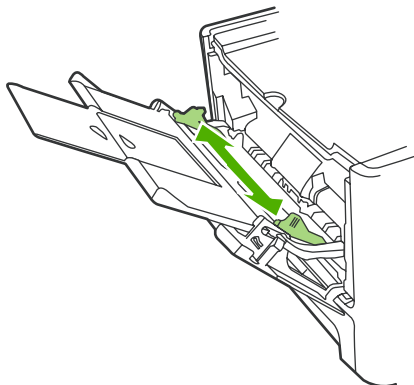

## Tray 2 or 3

Tray 2 and optional tray 3 hold up to 250 pages of 75 g/m<sup>2</sup> (20 lb) paper, or fewer pages of heavier media (25 mm (0.9 in) or less stack height). Load media with the top forward and the side to be printed on facing down.

Media guides ensure that the media feeds correctly into the product and that the print is not skewed. Tray 2 has side and rear media guides. When loading media, adjust the media guides to match the length and width of the media that you are using.

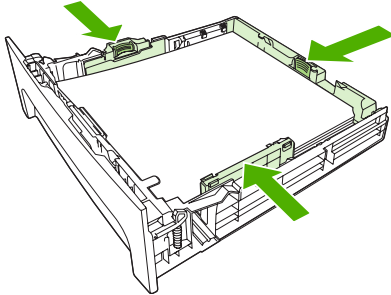

---

 **NOTE:** When you add new media, make sure that you remove all of the media from the input tray and straighten the stack of new media. Do not fan the media. This reduces jams by preventing multiple sheets of media from feeding through the product at one time.

---

# Configure trays

When using one of the trays for specific size of paper, you can set the default size for the tray in HP ToolboxFX or from the control panel. In HP ToolboxFX, select **Paper handling**, and then select the size for the tray you want to set. When you select that size of paper for a print job in the print dialog, the product automatically selects that tray for printing.

To set the default paper size or type from the control panel, complete the following steps.

1. On the product control panel, press **Setup**.
2. Use the arrow buttons to select **System setup**, and then press **OK**.
3. Use the arrow keys to select **Paper setup**, and then press **OK**.
4. Use the arrow keys to select the tray to be configured, and then press **OK**.
5. Use the arrow keys to select either **Paper type** or **Paper size**, and then press **OK**.
6. Use the arrow keys to select a default type or size for the tray, and then press **OK**.

## Change tray selection

The product is set to automatically pull media from trays that contain media. The product always pulls media from tray 1 if you insert media into tray 1. If there is no media in tray 1, the product attempts to pull media from tray 3, if installed, and then from tray 2.

You can specify which tray you want to use by changing the tray selection. **Auto select**, **Tray 1**, **Tray 2**, and **Tray 3** are available settings. **Auto select** will pull media from the first available tray with the appropriate matching media loaded.

---

 **NOTE:** **Tray 3** is only available if a tray 3 is installed.

---

### Change the tray selection for the current job

1. On the product control panel, press **Tray Select**.
2. Use the arrow buttons to select the input tray that you want to use.
3. Press **Start Copy** to save the selection and immediately start the copy job, or press **OK** to save the selection without starting the job.

### Change the default tray selection

1. On the product control panel, press **Setup**.
2. Use the arrow buttons to select **Copy setup**, and then press **OK**.
3. Use the arrow buttons to select **Def. Tray Select**, and then press **OK**.
4. Use the arrow buttons to select a tray setting, and then press **OK**.





---

# 7 Print tasks

This section provides information about common printing tasks.

- [Change the print driver to match the media type and size](#)
- [Get help for any print option](#)
- [Cancel a print job](#)
- [Create booklets](#)
- [Change print-quality settings](#)
- [Change print density](#)
- [Print on special media](#)
- [Use different paper and print covers](#)
- [Print a blank first page](#)
- [Resize documents](#)
- [Select a paper size](#)
- [Select a paper source](#)
- [Select a paper type](#)
- [Set the print orientation](#)
- [Use watermarks](#)
- [Save toner](#)
- [Create and use printing shortcuts in Windows](#)
- [Print on both sides of the paper \(duplex printing\)](#)
- [Print multiple pages on one sheet of paper in Windows](#)
- [Economy settings](#)
- [Fonts](#)



---

**NOTE:** Many of the functions that are described in this chapter also can be performed by using HP ToolboxFX. For instructions, see the HP ToolboxFX online Help.

---

## Change the print driver to match the media type and size

Selecting media by type and size results in significantly better print quality for heavy paper, glossy paper, and overhead transparencies. Using the wrong setting can result in unsatisfactory print quality. Always print by **Type** for special print media, such as labels or transparencies. Always print by **Size** for envelopes.

1. On the **File** menu in the software program, click **Print**.
2. Select the driver, and then click **Properties** or **Preferences**.
3. Click the **Paper/Quality** tab.
4. In the **Paper Type** or **Paper Size** list box, select the correct media type or size.
5. Click **OK**.

## Supported paper types and tray capacity

This product has the following tray priority for feeding print media:

1. Tray 1 (if open)
2. Tray 2
3. Optional tray 3 (if attached)

Minimum media dimensions are 76 x 127 mm (3 x 5 in).

Maximum media dimensions are 216 x 356 mm (8.5 x 14 in).

To obtain the best print results, change the paper size and paper type settings in the printer driver before printing.

Type is	Media specifications	Tray 1 capacity <sup>1</sup>	Tray 2 and optional tray 3 capacity <sup>2</sup>
Plain	75 g/m <sup>2</sup> (20 lb) to 104 g/m <sup>2</sup> (27 lb)	Up to 50 sheets	Up to 250 sheets
Color			
Preprinted			
Prepunched			
Recycled			
Light	60 g/m <sup>2</sup> (16 lb) to 75 g/m <sup>2</sup> (20 lb)	Up to 50 sheets	Up to 250 sheets
Envelopes	Less than 90 g/m <sup>2</sup> (24 lb)	Up to 5 envelopes	Not supported.
Labels	Standard	Up to 10 sheets	Not supported.
Bond	75 g/m <sup>2</sup> (20 lb) to 104 g/m <sup>2</sup> (27 lb)	Up to 10 sheets	Up to 250 sheets
Rough	75 g/m <sup>2</sup> (20 lb) to 104 g/m <sup>2</sup> (27 lb)	Up to 10 sheets	Up to 200 sheets
Transparencies	4 mm (0.1 inches) Monochrome Overhead	Up to 10 sheets	Not supported.

Type is	Media specifications	Tray 1 capacity <sup>1</sup>	Tray 2 and optional tray 3 capacity <sup>2</sup>
Mid weight	95 g/m <sup>2</sup> (25 lb) to 110 g/m <sup>2</sup> (29 lb)	Up to 10 sheets	Up to 200 sheets
Heavy	110 g/m <sup>2</sup> (29 lb) to 125 g/m <sup>2</sup> (33 lb)	Up to 10 sheets	Not supported.
Extra heavy	125 g/m <sup>2</sup> (33 lb) to 176 g/m <sup>2</sup> (47 lb)	Up to 10 sheets	Not supported.
Letterhead	75 g/m <sup>2</sup> (20 lb) to 104 g/m <sup>2</sup> (27 lb)	Up to 10 sheets	Up to 250 sheets

<sup>1</sup> The maximum stack height for tray 1 is 5 mm (0.2 inches).

<sup>2</sup> The maximum stack height for tray 2 is 25 mm (1 inch).

## Get help for any print option

Printer-driver Help is separate from program Help. The printer-driver help provides explanations for the buttons, check boxes, and drop-down lists that are in the printer driver. It also includes instructions for performing common printing tasks, such as printing on both sides, printing multiple pages on one sheet, and printing the first page or covers on different paper.

Activate the printer-driver Help screens in one of the following ways:

Windows	Macintosh
<ul style="list-style-type: none"> <li>In the printer driver <b>Properties</b> dialog box, click the <b>Help</b> button.</li> <li>Press the <b>F1</b> key on the computer keyboard.</li> <li>Click the question-mark symbol in the upper-right corner of the printer driver.</li> <li>Right-click on any item in the driver, and then click <b>What's This?</b>.</li> </ul>	<ul style="list-style-type: none"> <li>In the <b>Print</b> dialog box, click the ? button.</li> </ul>

## Cancel a print job

If the print job is currently printing, cancel it by pressing **Cancel** on the product control panel.

---

 **NOTE:** Pressing **Cancel** clears the job that the product is currently processing. If more than one process is running (for example, the product is printing a document while receiving a fax), pressing **Cancel** clears the process that currently appears on the product control panel.

---

You can also cancel a print job from a software program or a print queue.

To stop the print job immediately, remove the remaining print media from the product. After printing stops, use one of the following options:

- **Device control panel:** To cancel the print job, press and release **Cancel** on the product control panel.
- **Software program:** Typically, a dialog box appears briefly on the computer screen, allowing you to cancel the print job.
- **Windows print queue:** If a print job is waiting in a print queue (computer memory) or print spooler, delete the job there.
  - **Windows 2000:** Go to the **Printer** dialog box. Click **Start**, click **Settings**, and then click **Printers**. Double-click the product icon to open the window, select the print job, and then click **Delete**.
  - **Windows XP:** Click **Start**, click **Settings**, and then click **Printers and Faxes**. Double-click the product icon to open the window, right-click the print job that you want to cancel, and then click **Cancel**.
  - **Windows Vista:** Click **Start**, click **Control Panel**, and then, under **Hardware and Sound**, click **Printer**. Double-click the product icon to open the window, right-click the print job that you want to cancel, and then click **Cancel**.
- **Macintosh print queue:** Open the print queue by double-clicking the product icon in the dock. Highlight the print job, and then click **Delete**.

## Create booklets

You can copy two pages on one sheet of paper so you can fold the pages in the center to form a booklet. The device arranges the pages in the correct order. For example, if the original document has eight pages, the device prints pages 1 and 8 on the same sheet.

1. On the **File** menu in the software program, click **Print**.
2. Select the driver, and then click **Properties** or **Preferences**.
3. Click the **Finishing** tab.
4. Select **Print On Both Sides**.
5. In the drop-down box for **Booklet Layout**, select either **Left Edge Binding** or **Right Edge Binding**. The **Pages per Sheet** setting automatically changes to 2 pages per sheet.
6. Click **OK**.

## Change print-quality settings

1. On the **File** menu in the software program, click **Print**.
2. On the **Paper/Quality** tab, select the resolution or print-quality settings that you want from the **Print Quality** drop-down menu.
3. Click **OK**.

## Change print density

Increasing the print density at the product control panel darkens the print on the page.

1. On the control panel, press **Setup**.
2. Use the arrow buttons to select **System setup**, and then press **OK**.
3. Use the arrow buttons to select **Print Density**, and then press **OK**.
4. Use the arrow buttons to increase or decrease the density setting, and then press **OK**.

## Print on special media

Make sure that the paper or print media that you are using meets HP specifications. Generally, smoother paper provides better results.

1. Open the media input tray and remove any media.

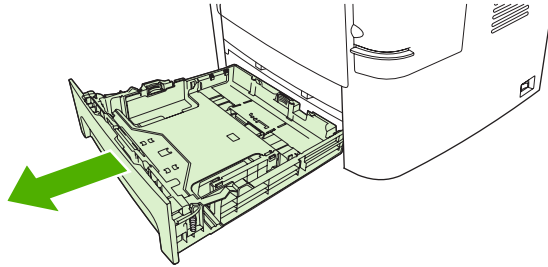

2. Load the media. Make sure that the top of the media is forward and the side to be printed on is facing up.
3. Adjust the media guides to the length and width of the media.

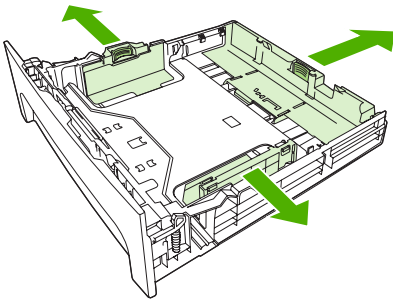

4. On the printer driver, on the **Paper** tab or the **Paper/Quality** tab, select the media type from the **Paper Type** drop-down list.

△ **CAUTION:** Be sure to set the correct media type in the product settings. The product adjusts the fuser temperature according to the media type setting. When printing on special media such as transparencies or labels, this adjustment prevents the fuser from damaging the media as it passes through the product.

5. Print the document.

## Use different paper and print covers

Follow these instructions for printing a first page that is different from other pages in the print job.

1. On the **File** menu in the software program, click **Print**.
2. Select the driver, and then click **Properties** or **Preferences**.
3. Click the **Paper/Quality** tab.
4. In the **Special pages** list box, click **Print pages on different paper**.
5. Click **Settings**.
6. Select the settings that you want to use to print specific pages on different paper. Click **Add**.
7. Click **OK** to return to the **Paper/Quality** tab.
8. Click **OK**.



---

**NOTE:** The paper size must be the same for all pages of the print job.

## Print a blank first page

1. On the **File** menu in the software program, click **Print**.
2. Select the driver, and then click **Properties** or **Preferences**.
3. Click the **Paper/Quality** tab.
4. In the **Special pages** list box, click **Covers**.
5. Click **Settings**.
6. Select the settings that you want to use to add blank or preprinted covers. Click **Add**.
7. Click **OK** to return to the **Paper/Quality** tab.
8. Click **OK**.

## Resize documents

Use the document resizing options to scale a document to a percentage of its normal size. You can also choose to print a document on a different size paper, with or without scaling.

### Reduce or enlarge a document

1. On the **File** menu in the software program, click **Print**.
2. Select the driver, and then click **Properties** or **Preferences**.
3. On the **Effects** tab, select **% of actual size**, and then type the percentage by which you want to reduce or enlarge the document.

You can also use the scroll bar to adjust the percentage.

4. Click **OK**.

### Print a document onto a different paper size

1. On the **File** menu in the software program, click **Print**.
2. Select the driver, and then click **Properties** or **Preferences**.
3. On the **Effects** tab, click **Print Document On**.
4. Select the paper size to print on.
5. To print the document without scaling it to fit, make sure that the **Scale to Fit** option is *not* selected.
6. Click **OK**.

## Select a paper size

1. On the **File** menu in the software program, click **Print**.
2. Select the driver, and then click **Properties** or **Preferences**.
3. On the **Paper/Quality** tab, select the size from the **Paper Size** drop-down list.
4. Click **OK**.

## Select a paper source

1. On the **File** menu in the software program, click **Print**.
2. Select the driver, and then click **Properties** or **Preferences**.
3. On the **Paper/Quality** tab, select the source from the **Paper Source** drop-down list.
4. Click **OK**.

## Select a paper type

1. On the **File** menu in the software program, click **Print**.
2. Select the driver, and then click **Properties** or **Preferences**.



3. On the **Paper/Quality** tab, select the type from the **Paper Type** drop-down list.
4. Click **OK**.

## Set the print orientation

1. On the **File** menu in the software program, click **Print**.
2. Select the driver, and then click **Properties** or **Preferences**.
3. On the **Finishing** tab, select either **Portrait** or **Landscape** in the **Orientation** section.
4. Click **OK**.

## Use watermarks

A watermark is a notice, such as "Confidential," that is printed in the background of each page of a document.

1. On the **File** menu in the software program, click **Print**.
2. Select the driver, and then click **Properties** or **Preferences**.
3. From the **Effects** tab, click the **Watermarks** drop-down list.
4. Click the watermark that you want to use. To create a new watermark, click **Edit**.
5. If you want the watermark to appear only on the first page of the document, click **First Page Only**.
6. Click **OK**.

To remove the watermark, click **(none)** in the **Watermarks** drop-down list.

## Save toner

1. On the **File** menu in the software program, click **Print**.
2. Select the driver, and then click **Properties** or **Preferences**.
3. On the **Paper/Quality** tab, click **EconoMode**.
4. Click **OK**.

# Create and use printing shortcuts in Windows

Use printing shortcuts to save the current driver settings for reuse. Shortcuts are available on most printer-driver tabs. You can save up to 25 printing shortcuts.

## Create a printing shortcut

1. On the **File** menu in the software program, click **Print**.
2. Select the driver, and then click **Properties** or **Preferences**.
3. On the **Printing Shortcuts** tab, select the print settings that you want to use. Click **Save As**.
4. In the **Printing Shortcuts** box, type a name for the shortcut.
5. Click **OK**.

## Use printing shortcuts

1. On the **File** menu in the software program, click **Print**.
2. Select the driver, and then click **Properties** or **Preferences**.
3. On the **Printing Shortcuts** tab, select the shortcut that you want to use from the **Printing shortcuts** box.
4. Click **OK**.

---

 **NOTE:** To use printer-driver default settings, select **Factory Defaults**.

---

# Print on both sides of the paper (duplex printing)

## Use automatic duplex printing

1. Insert enough paper into one of the trays to accommodate the print job. If you are loading special paper such as letterhead, load it in one of the following ways:
    - For tray 1, load the letterhead paper with the front side up, bottom-edge first.
    - For all other trays, load the letterhead paper with front side down, and the top edge at the back of the tray.
- 
- △ **CAUTION:** To avoid jams, do not load paper that is heavier than 105 g/m<sup>2</sup> (28 lb bond).
2. On the **File** menu in the software program, click **Print**.
  3. Select the driver, and then click **Properties** or **Preferences**.
  4. On the **Finishing** tab, click **Print on both sides**.
    - If necessary, select **Flip pages up** to change the manner in which pages are turned, or select a binding option in the **Booklet layout** list box.
  5. Click **OK**.

## Print on both sides manually

1. Insert enough paper into one of the trays to accommodate the print job. If you are loading special paper such as letterhead, load it in one of the following ways:
    - For tray 1, load the letterhead paper with the front side down, bottom-edge first.
    - For all other trays, load letterhead paper with front side up, and the top edge at the back of the tray.
- 
- △ **CAUTION:** To avoid jams, do not load paper that is heavier than 105 g/m<sup>2</sup> (28 lb bond).
2. On the **File** menu in the software program, click **Print**.
  3. Select the driver, and then click **Properties** or **Preferences**.
  4. On the **Finishing** tab, select **Correct order for straight paper path**, select **Print on both sides (manually)**, and then open the rear output bin door.
  5. Click **OK**.
  6. Send the print job to the product. Follow the instructions in the pop-up window that appears before feeding the output stack into tray 1 for printing the second half.
  7. Go to the product. Remove any blank paper that is in tray 1. Insert the printed stack with the printed side up, and the bottom-edge feeding into the product first. You must print the second side from tray 1.
  8. At the control panel, press **OK** to continue.

# Print multiple pages on one sheet of paper in Windows

You can print more than one page on a single sheet of paper.

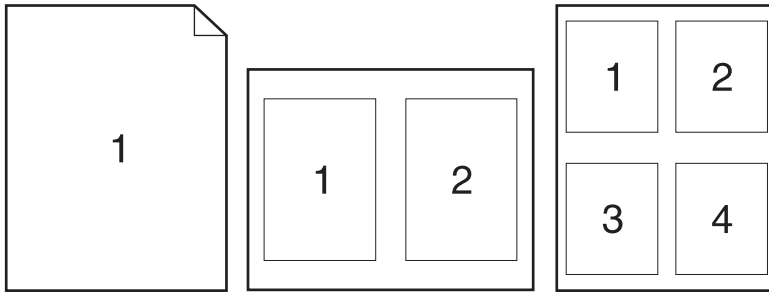

1. On the **File** menu in the software program, click **Print**.
2. Select the driver, and then click **Properties** or **Preferences**.
3. Click the **Finishing** tab.
4. In the **Pages per sheet** drop-down list, select the number of pages that you want to print on each sheet (1, 2, 4, 6, 9, or 16).
5. If the number of pages is greater than 1, select the correct options for **Print page borders** and **Page order**.
  - If you need to change the page orientation, click **Portrait** or **Landscape**.
6. Click **OK**. The product is now set to print the number of pages per sheet that you have selected.

# Economy settings

## EconoMode

The EconoMode setting in the product printer driver conserves toner. For instructions about using the EconoMode setting, see [Save toner on page 61](#).

## Archive print

Archive print produces output that is less susceptible to toner smearing and dusting. Use archive print to create documents that you want to preserve or archive.

1. On the control panel, press **Setup**.
2. Use the arrow buttons to select **Service**, and then press **OK**.
3. Use the arrow buttons to select **Archive print**, select **On** or **Off**, and then press **OK**.

## Fonts

### Select fonts

Use HP ToolboxFX to change product fonts by clicking the **Print Settings** tab, and then clicking the **PCL5e** page. Click **Apply** to save the changes.

### Print lists of available fonts

Print lists of the fonts available from the product control panel. See [Information pages on page 142](#).



---

# 8 Copy

- [Load originals](#)
- [Use copy](#)
- [Copy settings](#)
- [Copy a book](#)
- [Copy photos](#)
- [Copy mixed-size originals](#)
- [Duplex \(two-sided\) copy jobs](#)

# Load originals

## Automatic document feeder (ADF)

 **NOTE:** The ADF capacity is up to 50 sheets of 80 g/m<sup>2</sup> or 20 lb media.

 **CAUTION:** To prevent damage to the product, do not use an original that contains correction tape, correction fluid, paper clips, or staples. Also, do not load photographs, small originals, or fragile originals into the ADF. Use the flatbed glass to scan these items.

1. Insert the top-end of the stack of originals into the ADF input tray, with the media stack face-up and the first page to be copied on top of the stack.

If the media is longer than letter- or A4-sized paper, pull out the ADF input tray extension to support the media.

2. Slide the stack into the ADF until it does not move any farther.

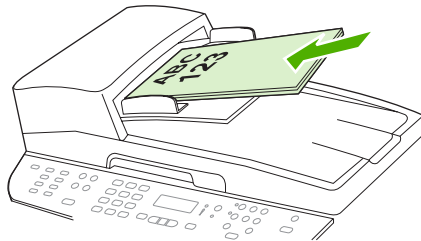

**Document loaded** appears on the control-panel display.

3. Adjust the media guides until they are snug against the media.

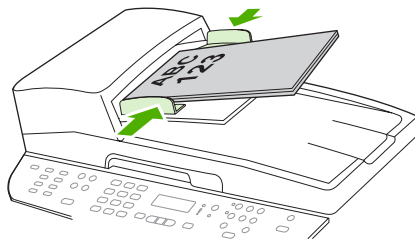

## Flatbed scanner

 **NOTE:** The maximum media size for flatbed scanning is letter. Use the ADF for scanning media larger than letter.

1. Make sure that the automatic document feeder (ADF) contains no media.
2. Lift the flatbed scanner cover.



3. Place the original document face-down on the flatbed scanner with the upper-left corner of the document at the corner indicated by the icon on the scanner.

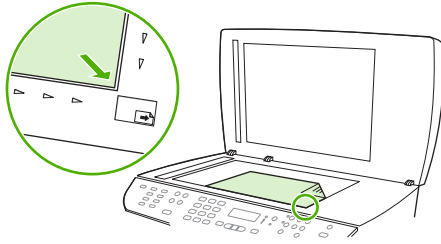

4. Gently close the lid.

## Use copy

### One-touch copy

1. Load the document into the automatic document feeder (ADF) input tray or onto the flatbed scanner.
2. Press **Start Copy** on the product control panel to start copying.
3. Repeat the process for each copy.

### Multiple copies

You can choose to have the default number of copies be any number from 1 to 99.

#### Change the number of copies for the current job

1. On the product control panel, press **# of Copies**.
2. Use the alphanumeric buttons to type the number of copies (between 1 and 99) that you want to make for your current job.
3. Press **Start Copy** to begin copying your job.

---

 **NOTE:** The change in the setting remains active for about 2 minutes after the copy job has been completed. During this time, **Custom settings** appears on the product control-panel display.

---

#### Change the default number of copies

1. On the product control panel, press **Setup**.
2. Use the arrow buttons to select **Copy setup**, and then press **OK**.
3. Use the arrow buttons to select **Def. # of copies**, and then press **OK**.
4. Use the alphanumeric buttons to type the number of copies (between 1 and 99) that you want as the default.
5. Press **OK** to save your selection.

---

 **NOTE:** The factory-set default for the number of copies is **1**.

---

## Cancel a copy job

To cancel a copy job, press **Cancel** on the product control panel. If more than one process is running, pressing **Cancel** clears the process that currently appears on the product control-panel display.

 **NOTE:** If you cancel a copy job, clear the document from the flatbed scanner or from the automatic document feeder.

---

## Reduce or enlarge copies

### Reduce or enlarge copies for the current job

1. On the product control panel, press **Reduce/Enlarge**.
2. Select the size to which you would like to reduce or enlarge the copies in this job.

 **NOTE:** If you select **Custom: 25-400%**, type a percentage by using the alphanumeric buttons.

If you select **2 pages/sheet** or **4 pages/sheet**, select the orientation (portrait or landscape).

---

3. Press **Start Copy** to save the selection and immediately start the copy job, or press **OK** to save the selection without starting the job.

 **NOTE:** The change in the setting remains active for about 2 minutes after the copy job has been completed. During this time, **Custom settings** appears on the product control-panel display.

You must change the default media size in the media input tray to match the output size, or part of your copy might be cut off.

---

### Adjust the default copy size

 **NOTE:** The default copy size is the size to which copies are normally reduced or enlarged. If you keep the factory default size setting of **Original=100%**, all copies will be the same size as the original document.

---

1. Press **Setup**.
2. Use the arrow buttons to select **Copy setup**, and then press **OK**.
3. Use the arrow buttons to select **Def. Redu/Enlrg**, and then press **OK**.
4. Use the arrow buttons to select the option for how you normally want to reduce or enlarge copies.

 **NOTE:** If you select **Custom: 25-400%**, type in the percentage of the original size that you normally want for copies.

If you select **2 pages/sheet** or **4 pages/sheet**, select the orientation (portrait or landscape).

---

5. Press **OK** to save the selection.

The product can reduce copies to as little as 25% of the original size or enlarge copies to as much as 400% of the original size.

### Reduction/enlargement settings

- **Original=100%**
- **Lgl > Ltr=78%**

- **Lgl > A4=83%**
- **A4 > Ltr=94%**
- **Ltr > A4=97%**
- **Full Page=91%**
- **Fit to page**
- **2 pages/sheet**
- **4 pages/sheet**
- **Custom: 25-400%**

---

 **NOTE:** When using the **Fit to page** setting, copy from the flatbed scanner only.

When using the **2 pages/sheet** or **4 pages/sheet** setting, copy from the automatic document feeder only. Also, after selecting the **2 pages/sheet** or **4 pages/sheet** option, you must select the page orientation (portrait or landscape).

---

## Change the copy-collation setting

You can set the product to automatically collate multiple copies into sets. For example, if you are making two copies of three pages and the automatic collation is on, the pages print in this order: 1,2,3,1,2,3. If automatic collation is off, the pages print in this order: 1,1,2,2,3,3.

To use the automatic collation, the original document size must fit into the memory. If it does not, the product makes only one copy and a message appears notifying you of the change. If that happens, use one of the following methods to finish the job:

- Split the job into smaller jobs that contain fewer pages.
- Make only one copy of the document at a time.
- Turn off the automatic collation.

### Change the copy-collation setting for the current job

1. On the product control panel, press **Collate**.
2. Use the arrow buttons to select **On** or **Off**.
3. Press **Start Copy** to save the selection and immediately start the copy job, or press **OK** to save the selection without starting the job.

### Change the default copy-collation setting

1. On the product control panel, press **Setup**.
2. Use the arrow buttons to select **Copy setup**, and then press **OK**.
3. Use the arrow buttons to select **Def. Collation**, and then press **OK**.
4. Use the arrow buttons to select **On** or **Off**.
5. Press **OK** to save the selection.

---

 **NOTE:** The factory-set default for automatic copy collation is **On**.

The **Collate** LED on the control panel is on when collation is on.

---

## Copy settings

### Copy quality

Four copy-quality settings are available: **Text**, **Mixed**, **Film photo**, and **Picture**.

The factory-set default for copy quality is **Text**. This setting is the best for items that contain mostly text.

When making a copy of a photo or graphic, you can select the **Film photo** setting for photos or the **Picture** setting for other graphics to increase the quality of your copy. Select the **Mixed** setting for documents that include both text and graphics.

#### Adjust the copy quality for the current job

1. On the product control panel, press **Quality** to see the current quality setting for the copy.
2. Use the arrow buttons to scroll through the quality setting options.
3. Select a setting, and then press **Start Copy** to save the selection and immediately start the copy job, or press **OK** to save the selection without starting the job.

---

 **NOTE:** The change in the setting remains active for about 2 minutes after the copy job has been completed. During this time, **Custom settings** appears on the product control-panel display.

---

#### Adjust the default copy quality

1. On the product control panel, press **Setup**.
2. Use the arrow buttons to select **Copy setup**, and then press **OK**.
3. Use the arrow buttons to select **Default quality**, and then press **OK**.
4. Use the arrow buttons to select the copy quality, and then press **OK** to save the selection.

### Clean the scanner glass

Dirty glass, from fingerprints, smudges, hair, and so on, slows down performance and affects the accuracy of special features such as fit-to-page and copy.

---

 **NOTE:** If streaks or other defects appear only on copies produced using the automatic document feeder (ADF), clean the scanner strip (step 3). It is not necessary to clean the scanner glass.

---

1. Turn off the product, unplug the power cord from the electrical socket, and raise the lid.

2. Clean the glass by using a soft, lint-free cloth or sponge that has been moistened with nonabrasive glass cleaner.

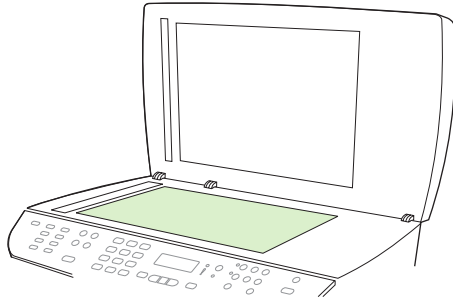

---

△ **CAUTION:** Do not use abrasives, acetone, benzene, ammonia, ethyl alcohol, or carbon tetrachloride on any part of the product; these can damage the product. Do not place liquids directly on the glass. They might seep under it and damage the product.

---

3. Clean the scanner strip by using a soft, lint-free cloth or sponge that has been moistened with nonabrasive glass cleaner..

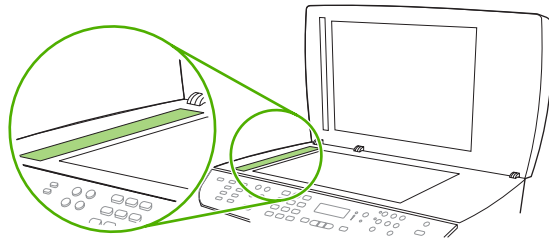

4. To prevent spotting, dry the glass by using a chamois or cellulose sponge.

## Adjust the lighter/darker (contrast) setting

The lighter/darker setting affects the lightness or darkness (contrast) of the copy. Use the following procedure to change the contrast for the current copy job only.

### Adjust the lighter/darker setting for the current job

1. On the product control panel, press **Lighter/Darker** to see the current contrast setting.
2. Use the arrow buttons to adjust the setting. Move the slider to the left to make the copy lighter than the original, or move the slider to the right to make the copy darker than the original.
3. Press **Start Copy** to save the selection and immediately start the copy job, or press **OK** to save the selection without starting the job.

---

📄 **NOTE:** The change in the setting remains active for about 2 minutes after the copy job has been completed. During this time, **Custom settings** appears on the product control-panel display.

---

### Adjust the default lighter/darker setting

---

📄 **NOTE:** The default lighter/darker setting affects all copy jobs.

---

1. On the product control panel, press **Setup**.
2. Use the arrow buttons button to select **Copy setup**, and then press **OK**.

3. Use the arrow buttons button to select **Def. Light/dark**, and then press **OK**.
4. Use the arrow buttons button to adjust the setting. Move the slider to the left to make all of the copies lighter than the original, or move the slider to the right to make all of the copies darker than the original.
5. Press **OK** to save the selection.

## Set the copy draft setting

Use the control panel to set the product to print copies in draft mode.

 **NOTE:** This setting affects copy quality only. Print quality is not affected.

---

1. On the product control panel, press **Setup**.
2. Use the arrow buttons to select **Copy setup**, and then press **OK**.
3. Use the arrow buttons to select **Def. Copy Draft**, and then press **OK**.
4. Use the arrow buttons to select **On** or **Off**.
5. Press **OK** to save the selection.

## Define custom copy settings

When you change the copy settings at the control panel, **Custom settings** appears on the control-panel display. The custom settings remain in effect for approximately 2 minutes, and then the product returns to the default settings. To immediately return to the default settings, press **Cancel**.

## Print or copy edge-to-edge

The product cannot print fully edge-to-edge. The maximum printing area is 203.2 x 347 mm (8 x 13.7 in), leaving a 4 mm unprintable border around the page.

## Copy onto media of different types and sizes

The product is set to copy on either letter- or A4-size paper, depending on the country/region in which it was purchased. You can change the size and type of media that you copy to for the current copy job or for all copy jobs.

### Media-size settings

- **Letter**
- **Legal**
- **A4**

### Media-type settings

- **Plain**
- **Light**
- **Heavy**
- **Transparency**

- **Labels**
- **Letterhead**
- **Envelope**
- **Preprinted**
- **Prepunched**
- **Colored**
- **Bond**
- **Recycled**
- **Mid weight**
- **Extra heavy**
- **Rough**

### Change the media size and type for the current job

 **NOTE:** Change the default media size and type settings to change the media size and type.

1. On the product control panel, press **Paper**.
2. Use the arrow buttons to select a media size, and then press **OK**.
3. Use the arrow buttons button to select a media type, and then press **OK**.
4. Press **Start Copy**.

### Change the default media-size setting

1. On the product control panel, press **Setup**.
2. Use the arrow buttons to select **System setup**, and then press **OK**.
3. Use the arrow buttons to select **Paper setup**, and then press **OK**.
4. Use the arrow buttons to select **Def. paper size**, and then press **OK**.
5. Use the arrow buttons to select a media size, and then press **OK**.
6. Press **OK** to save the selection.

### Change the default media-type setting

1. On the product control panel, press **Setup**.
2. Use the arrow buttons to select **System setup**, and then press **OK**.
3. Use the arrow buttons to select **Paper setup**, and then press **OK**.
4. Use the arrow buttons to select **Def. paper type**, and then press **OK**.
5. Use the arrow buttons to select a media type, and then press **OK**.
6. Press **OK** to save the selection.

## Restore the copy-settings defaults

Use the control panel to restore the copy settings to the factory-set default values.

1. On the product control panel, press **Setup**.
2. Use the arrow buttons to select **Copy setup**, and then press **OK**.
3. Use the arrow buttons to select **Restore defaults**, and then press **OK**.

## Copy a book

1. Lift the lid and place the book on the flatbed scanner with the page that you want to copy at the lower-right corner of the glass.

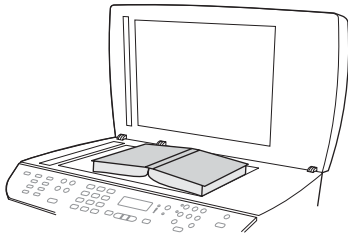

2. Gently close the lid.

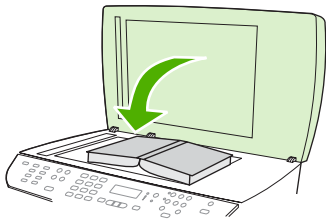

3. Gently press down on the lid to press the book to the flatbed scanner surface.

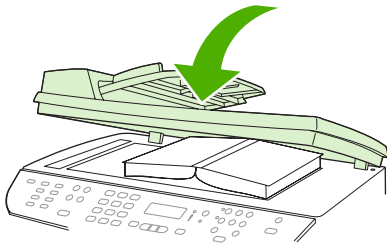

△ **CAUTION:** Pressing on the flatbed cover with too much force can break the lid hinges.

4. Press **Start Copy**.

## Copy photos



---

 **NOTE:** Photographs should be copied from the product flatbed scanner, not from the automatic document feeder (ADF).

---

1. Lift the lid and place the photo on the flatbed scanner with the picture-side down and the upper-left corner of the photo in the lower-right corner of the glass.

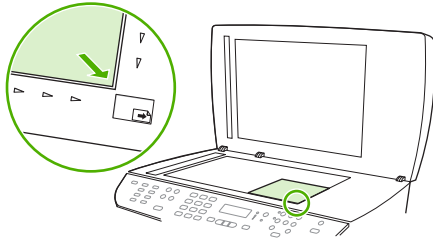

2. Gently close the lid.
3. Press **Start Copy**.

# Copy mixed-size originals

Use the flatbed scanner when making copies of mixed-size originals. Do not use the ADF.

# Duplex (two-sided) copy jobs

## Copy two-sided documents automatically

Use the **2-Sided** button on the control panel display to use duplexing to achieve various results.

 **NOTE:** The default setting is **1-1**. The **2-Sided** LED on the control panel turns on when another setting is used.

**Table 8-1 2-Sided settings**

Document type	2-Sided setting	Resulting copies	2-Sided LED
One-sided	<b>1-1</b>	One-sided	Off
One-sided	<b>1-2</b>	Two-sided	On
Two-sided	<b>2-2</b>	Two-sided	On
Two-sided	2-1	One-sided	On

### Make two-sided copies from one-sided documents

1. Load the documents to be copied into the automatic document feeder (ADF) input tray with the first page facing up, and with the top of the page leading into the ADF.
2. On the product control panel, press **2-Sided**.
3. Use the arrow buttons to select **Copy to 1 to 2 sided**, and then press **OK**.
4. Press **Start Copy**.

### Make two-sided copies from two-sided documents

1. Load the documents to be copied into the automatic document feeder (ADF) input tray with the first page facing up, and with the top of the page leading into the ADF.

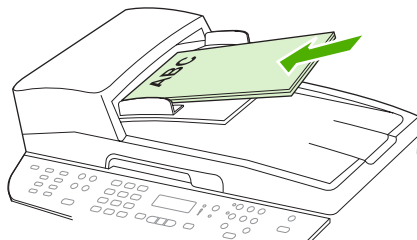

2. On the product control panel, press **2-Sided**.
3. Use the arrow buttons to select **Copy to 2 to 2 sided**, and then press **OK**.
4. Press **Start Copy**.

## Change the default 2-Sided setting

1. On the product control panel, press **Setup**.
2. Use the arrow buttons to select **Copy setup**, and then press **OK**.
3. Use the arrow buttons to select **Default 2-sided**, and then press **OK**.
4. Use the arrow buttons to select the option for how you normally want to use the automatic duplexer when you copy documents.
5. Press **OK** to save the selection.

## Copy two-sided documents manually

### Set the multiple-page flatbed copy setting

The multiple-page flatbed copy setting must be set to **On** before the product will produce two-sided copies from the flatbed scanner.

1. On the product control panel, press **Setup**.
2. Use the arrow buttons to select **Copy setup**, and then press **OK**.
3. Press **OK** to select **Def. Multi-page**.
4. Use the arrow buttons to select **On** or **Off**.
5. Press **OK** to save the selection.

---

 **NOTE:** The factory-set default for automatic copy collation is **On**.

The **Collate** LED on the control panel is on when collation is on.

---

### Copy two-sided documents manually

1. Load the first page of the document on the flatbed scanner.

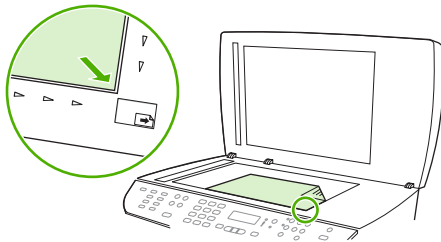

2. Press **2-Sided**, and then use the arrow buttons to select the correct setting.
3. Press **OK**, and then press **Start Copy**.
4. Remove the first page, and then load the second page onto the flatbed scanner.
5. Press **OK**, and then repeat the process until all of the pages in the original have been copied.
6. When the copy job is completed, press **Start Copy** to return the product to Ready mode.



---

# 9 Scan

- [Load originals for scanning](#)
- [Use scan](#)
- [Scan settings](#)
- [Scan a book](#)
- [Scan a photo](#)

# Load originals for scanning

## Automatic document feeder (ADF)

 **NOTE:** The ADF capacity is up to 50 sheets of 80 g/m<sup>2</sup> or 20 lb media.

 **CAUTION:** To prevent damage to the product, do not use an original that contains correction tape, correction fluid, paper clips, or staples. Also, do not load photographs, small originals, or fragile originals into the ADF. Use the flatbed glass to scan these items.

1. Insert the top-end of the stack of originals into the ADF input tray, with the media stack face-up and the first page to be copied on top of the stack.

If the media is longer than letter- or A4-sized paper, pull out the ADF input tray extension to support the media.

2. Slide the stack into the ADF until it does not move any farther.

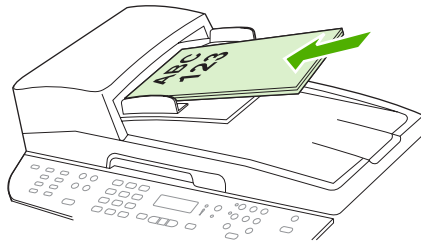

**Document loaded** appears on the control-panel display.

3. Adjust the media guides until they are snug against the media.

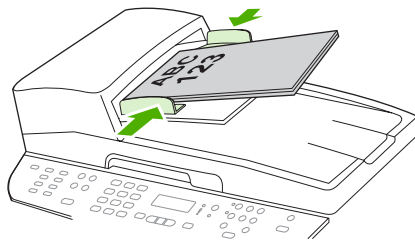

## Flatbed scanner

 **NOTE:** The maximum media size for flatbed scanning is letter. For media larger than letter, use the ADF.

1. Make sure that the automatic document feeder (ADF) contains no media.
2. Lift the flatbed scanner cover.

3. Place the original document face-down on the flatbed scanner with the upper-left corner of the document at the corner indicated by the icon on the scanner.

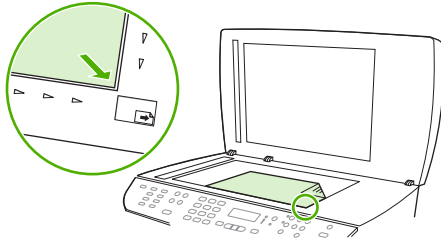

4. Gently close the lid.

## Use scan

### Scan methods

Scan jobs can be performed in the following ways.

- Scan from the computer by using HP LaserJet Scan (Windows)
- Scanning by using HP Director (Macintosh). See [Scan from the product and HP Director \(Macintosh\) on page 35](#).
- Scan from the product
- Scan from TWAIN-compliant or Windows Imaging Application (WIA)-compliant software

---

 **NOTE:** To learn about and use text-recognition software, install the Readiris program from the software CD-ROM. Text-recognition software is also known as optical character recognition (OCR) software.

---

### Scan by using HP LaserJet Scan (Windows)

1. In the HP program group, select **Scan** to start HP LaserJet Scan.

---

 **NOTE:** Pressing **Start Scan** on the product control panel also starts HP LaserJet Scan.

---

2. Choose the action that you want to accomplish.
  - Select a destination to begin scanning immediately.
  - Select **Scan after prompting me for settings** to specify additional settings before you begin scanning.
  - Select **Set up the device** to program the **Scan To** button.
3. Click **OK**.

---

 **NOTE:** **OK** should indicate the action that you want to accomplish.

---

## Scan from the product

 **NOTE:** In order to use the [Scan To](#) button, you must have performed the recommended installation, and the button must have destinations set. See [Set up the product Scan To button on page 85](#).

In order to use the [Start Scan](#) button, the product must be connected to a computer via USB or a network.

Scan directly from the product by using the control-panel scan buttons. Press [Start Scan](#) or [Scan To](#) to scan to a folder (Windows only) or to scan to e-mail.

## Scan by using other software

The product is TWAIN-compliant and Windows Imaging Application (WIA)-compliant. The product works with Windows-based programs that support TWAIN-compliant or WIA-compliant scanning devices and with Macintosh-based programs that support TWAIN-compliant scanning devices.

While you are in a TWAIN-compliant or WIA-compliant program, you can gain access to the scanning feature and scan an image directly into the open program. For more information, see the Help file or the documentation that came with your TWAIN-compliant or WIA-compliant software program.

### Scan from a TWAIN-compliant program

Generally, a software program is TWAIN-compliant if it has a command such as **Acquire**, **File Acquire**, **Scan**, **Import New Object**, **Insert from**, or **Scanner**. If you are unsure whether the program is compliant or you do not know what the command is called, see the software program Help or documentation.

When scanning from a TWAIN-compliant program, the HP LaserJet Scan software program might start automatically. If the HP LaserJet Scan program starts, you can make changes while previewing the image. If the program does not start automatically, the image goes to the TWAIN-compliant program immediately.

Start the scan from within the TWAIN-compliant program. See the software program Help or documentation for information about the commands and steps to use.

### Scan from a WIA-compliant program (Windows XP and Vista only)

WIA is another way to scan an image directly into a software program, such as Microsoft Word. WIA uses Microsoft software to scan, instead of HP LaserJet Scan software.

Generally, a software program is WIA-compliant if it has a command such as **Picture/From Scanner or Camera** in the Insert or File menu. If you are unsure whether the program is WIA-compliant, see the software program Help or documentation.

Start the scan from within the WIA-compliant program. See the software program Help or documentation for information about the commands and steps to use.

**-Or-**

In the Cameras and Scanner folder, double-click the product icon. This opens the standard Microsoft WIA Wizard, which enables you to scan to a file.

## Scanning by using optical character recognition (OCR) software

You can use third-party OCR software to import scanned text into your preferred word-processing program for editing.



## Readiris

The Readiris OCR program is included on a separate CD-ROM that shipped with the product. To use the Readiris program, install it from the appropriate software CD-ROM, and then follow the instructions in the online Help.

## Use the Scan To feature

- Scanning from the product control panel is only supported with a full software installation. HP ToolboxFX must be running to scan by using the **Scan To** button or the **Start Scan** button.
- For the best scan quality, place your originals onto the flatbed scanner, rather than loading them into the automatic document feeder (ADF) input tray.
- The computer that is connected to the product must be turned on.

## Set up the product Scan To button

Destinations must be set up prior to using the **Scan To** button on the control panel. Use HP LaserJet Scan to program the folder, e-mail, and program destinations for scanning.

### Set up destinations on the product

1. Click **Start**, click **Programs** (or **All Programs** in Windows XP), click **HP**, click the product, click **Scan**, and then click **Settings**.
2. Select **Change the destinations that show up on the all-in-one control panel**.
3. The product is pre-configured with the following three destinations in the dialog box.
  - Scan a document and attach it to an e-mail
  - Scan a photo and attach it to an e-mail
  - Scan a photo and save it as a file
4. Highlight a destination and click the arrow to move to the destinations currently on the dialog box. Repeat for all three destinations.
5. Click **Update**.

### Add destinations

1. Click **Start**, click **Programs** (or **All Programs** in Windows XP), click **HP**, click the product, click **Scan**, and then click **Settings**.
2. Select **Create a new destination with settings that I specify**.
3. Do one of the following:
  - For folders, select **Save it to my computer**, and then click **Next**.
  - For e-mail, select **Attach to a new e-mail**, and then click **Next**.
  - For programs, select **Open it in another software application**, and then click **Next**.
4. Enter the file destination name or check to set up the destination on the product. Name the default destination, and then click **Next**.

5. Select the quality and click **Next**.
6. Verify the selections, and then click **Save**.

### Delete destinations

1. From the **Set up the <Scan To> list for the All-in-One**, select one of the **Available Destinations on this PC** and click **Delete**. The **Delete Destination** dialog box displays.
2. From the **Delete Destination** dialog box, highlight the destination to delete and click **Next**. The **Confirmation** dialog box displays.
3. Click **Delete** to perform the deletion, or click **Cancel** to choose another destination.

### Scan to a file, e-mail, or software program

---

 **NOTE:** To use this feature in Windows, a destination must be programmed in the scan setup before scanning to a destination. See [Set up the product Scan To button on page 85](#).

---

1. Load the originals that are to be scanned face-up in the automatic document feeder (ADF) input tray, with the top of the document forward, and adjust the media guides.

**-or-**

Lift the flatbed scanner lid and load the original that is to be scanned face-down on the flatbed scanner with the top, left corner of the document located in the lower-right corner of the glass. Gently close the lid.

2. On the product control panel, press **Scan To**.
3. Use the arrow buttons to select a file destination.
4. Press **Start Scan** or **OK** to scan the document to a file.

---

 **NOTE:** Scanning to e-mail is supported by any e-mail program that supports the Messaging Application Programming Interface (MAPI) protocol. Many versions of popular e-mail programs seem to be MAPI-compliant. See the support information for your e-mail program to determine whether or not it is MAPI-compliant.

---

### Canceling a scan job

To cancel a scan job, use one of the following procedures.

- On the product control panel, press **Cancel**.
- Click the **Cancel** button in the onscreen dialog box.

If you cancel a scan job, remove the original from the flatbed scanner or from the automatic document feeder (ADF) input tray.

# Scan settings

## Scan file format

The file format of a scanned document or photo depends on the scan type as well as the object being scanned.

- Scanning a document or a photo to a computer results in the file being saved as a .TIF file.
- Scanning a document to email results in the file being saved as a .PDF file.
- Scanning a photo to e-mail results in the file being saved as a .JPEG file.

---

 **NOTE:** Different file types can be selected when using the scan software program.

---

## Scanner resolution and color

If you are printing a scanned image, and the quality is not what you expected, you might have selected a resolution or color setting in the scanner software that does not match your needs. Resolution and color affect the following features of scanned images:

- Image clarity
- Texture of gradations (smooth or rough)
- Scan time
- File size

Scanning resolution is measured in pixels per inch (ppi).

---

 **NOTE:** Scanning ppi levels are not interchangeable with printing dpi (dots per inch) levels.

---

Color, grayscale, and black and white define the number of colors possible. You can adjust the scanner hardware resolution to up to 1200 ppi. The software can perform an enhanced resolution up to 19,200 ppi. You can set color and grayscale at 1 bit (black and white), or at 8 bit (256 levels of gray or color) to 24 bit (true color).

The resolution and color guidelines table lists simple tips that you can follow to meet your scanning needs.

---

 **NOTE:** Setting the resolution and color to a high value can create large files that take up disk space and slow the scanning process. Before setting the resolution and color, determine how you are going to use the scanned image.

---

**NOTE:** The best resolution for color and grayscale images is achieved by scanning from the flatbed scanner rather than from the automatic document feeder (ADF).

---

## Resolution and color guidelines

The following table describes the recommended resolution and color settings for different types of scan jobs.

Intended use	Recommended resolution	Recommended color settings
Fax	150 ppi	<ul style="list-style-type: none"><li>● Black and White</li></ul>
E-mail	150 ppi	<ul style="list-style-type: none"><li>● Black and White, if the image does not require smooth gradation</li><li>● Grayscale, if the image requires smooth gradation</li><li>● Color, if the image is in color</li></ul>
Edit text	300 ppi	<ul style="list-style-type: none"><li>● Black and White</li></ul>
Print (graphics or text)	600 ppi for complex graphics, or if you want to significantly enlarge the document 300 ppi for normal graphics and text 150 ppi for photos	<ul style="list-style-type: none"><li>● Black and White for text and line art</li><li>● Grayscale for shaded or colored graphics and photos</li><li>● Color, if the image is in color</li></ul>
Display on screen	75 ppi	<ul style="list-style-type: none"><li>● Black and White for text</li><li>● Grayscale for graphics and photos</li><li>● Color, if the image is in color</li></ul>

## Color

You can set the color values to the following settings when scanning.

Setting	Recommended use
Color	Use this setting for high-quality color photos or documents in which the color is important.
Black and White	Use this setting for text documents.
Grayscale	Use this setting when file size is an issue or when you want a document or photograph to be scanned quickly.

## Scan quality

### Clean the scanner glass

Dirty glass, from fingerprints, smudges, hair, and so on, slows down performance and affects the accuracy of special features such as fit-to-page and copy.

 **NOTE:** If streaks or other defects appear only on copies produced using the automatic document feeder (ADF), clean the scanner strip (step 3). It is not necessary to clean the scanner glass.

1. Turn off the product, unplug the power cord from the electrical socket, and raise the lid.

2. Clean the glass by using a soft cloth or sponge that has been moistened with nonabrasive glass cleaner.

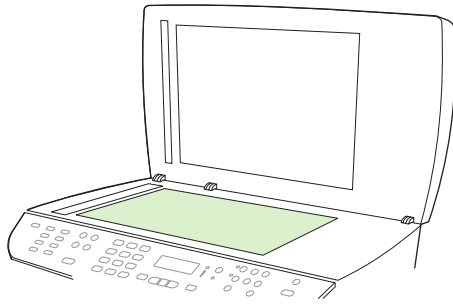

---

△ **CAUTION:** Do not use abrasives, acetone, benzene, ammonia, ethyl alcohol, or carbon tetrachloride on any part of the product; these can damage the product. Do not place liquids directly on the glass. They might seep under it and damage the product.

---

3. Clean the scanner strip by using a soft cloth or sponge that has been moistened with nonabrasive glass cleaner.

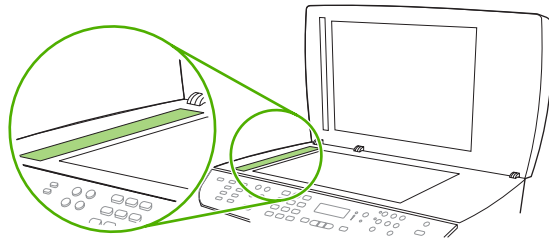

4. To prevent spotting, dry the glass by using a chamois or cellulose sponge.

## Scan a book

1. Lift the lid and place the book on the flatbed scanner with the page that you want to copy at the lower-right corner of the glass.

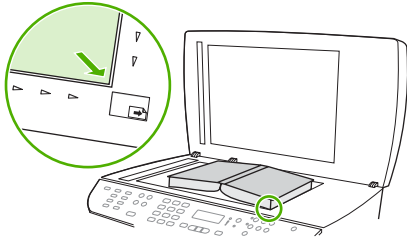

2. Gently close the lid.

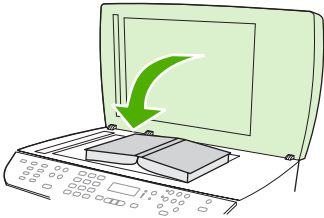

3. Gently press down on the lid to press the book to the flatbed scanner surface.

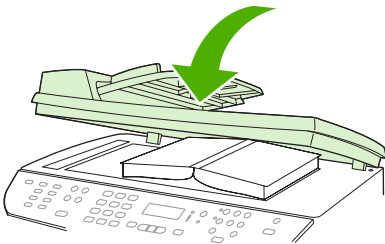

---

△ **CAUTION:** Pressing on the flatbed cover with too much force can break the lid hinges.

---

4. Scan the book by using one of the scanning methods.

## Scan a photo

1. Place the photo on the flatbed scanner with the picture-side down and the upper-left corner of the photo in the lower-right corner of the glass.

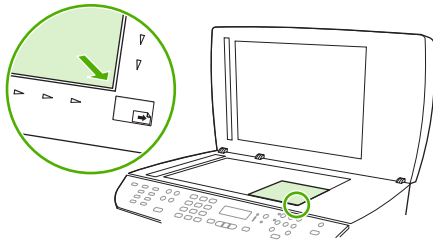

2. Gently close the lid.
3. Scan the photo by using one of the scanning methods.





---

# 10 Fax

- [Fax features](#)
- [Setup](#)
- [Change fax settings](#)
- [Use fax](#)
- [Solve fax problems](#)

---

 **NOTE:** Many of the functions that are described in this chapter also can be performed by using HP ToolboxFX or the embedded Web server. For more information, see the HP ToolboxFX online Help or [Embedded Web server on page 153](#).

---

For information about the fax controls on the control panel, see [Control panel on page 9](#).

## Fax features

The product has the following fax features, which are available from the control panel or from the product software.

- Fax Setup Wizard for easy fax configuration
- Plain-paper analog fax with 50-page automatic document feeder (ADF) and output tray of up to 125-page paper capacity
- 120-entry phone book and 16 speed dials from the control panel
- Automatic redial
- Digital storage of up to 400 fax pages
- Fax forwarding
- Delayed sending of faxes
- Ring features: Configure rings to answer and distinctive ring compatibility (service required through local telecommunications company)
- Fax confirmation report
- Junk fax blocking
- Fax security
- Eight cover page templates available

---

 **NOTE:** Not all features are listed. The product software might need to be installed for some features to be available.

---

# Setup



## Install and connect the hardware

### Connect to a telephone line

The product is an analog device. HP recommends using the product on a dedicated analog telephone line. For information about using the product with other telephone environments, see [Use fax on a DSL, PBX, ISDN, or VoIP system on page 117](#).

### Connect additional devices

The product includes two fax ports:

- The “line out” port (  ), which connects the product to the wall telephone jack.
- The “telephone” port (  ), which connects additional devices to the product.

Telephones used in conjunction with the product can be employed in two ways:

- An extension phone is a phone plugged into the same phone line at another location.
- A downstream phone is one that is plugged into the product or a device that is plugged into the product.

Connect additional devices in the order that is described in the following steps. The output port for each device is connected to the input port of the next, forming a "chain". If you do not want to connect a specific device, skip the step that explains it and continue to the next device.

---

 **NOTE:** Do not connect more than three devices to the telephone line.

---

**NOTE:** Voicemail is not supported with this product.

---

1. Unplug the power cords for all of the devices that you want to connect.
2. If the product is not yet connected to a telephone line, see the getting started guide before proceeding. The product should already be connected to a telephone jack.
3. Remove the plastic insert from the "telephone" port (the port that is marked with the telephone icon).

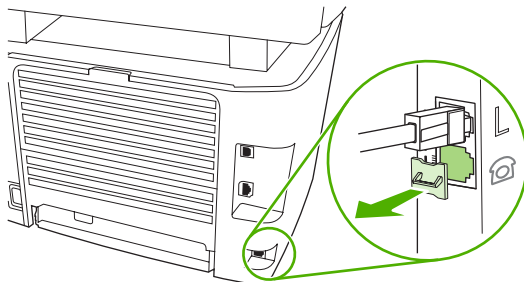

4. To connect an internal or external modem on a computer, plug one end of a telephone cord into the product “telephone” port (  ). Plug the other end of the telephone cord into the modem “line” port.

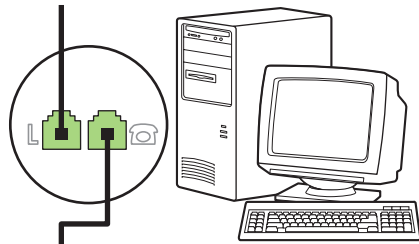
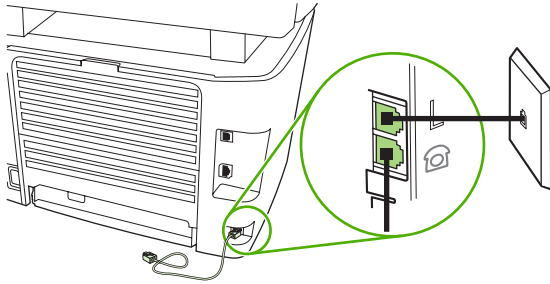

 **NOTE:** Some modems have a second “line” port to connect to a dedicated voice line. If you have two “line” ports, see your modem documentation to make sure that you connect to the correct “line” port.

5. To connect a caller-ID box, plug a telephone cord into the previous device’s “telephone” port. Plug the other end of the telephone cord into the caller-ID box “line” port.

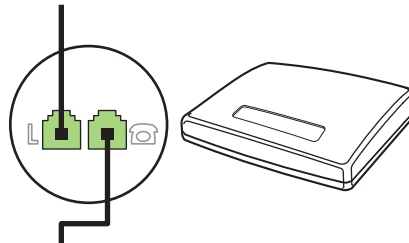

6. To connect an answering machine, plug a telephone cord into the previous device’s “telephone” port. Plug the other end of the telephone cord into the answering machine “line” port.

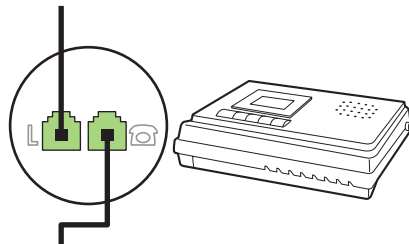

7. To connect a telephone, plug a telephone cord into the previous device's "telephone" port. Plug the other end of the telephone cord into the telephone "line" port.

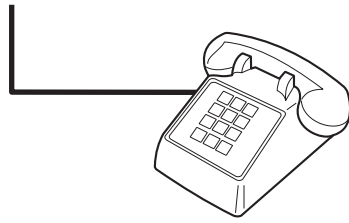

8. After you have finished connecting additional devices, plug all of the devices into their power sources.

### Set up fax with a telephone answering machine

- Set the product rings-to-answer setting for at least one ring more than the number of rings for which the answering machine is set.
- If an answering machine is connected to the same telephone line but on a different jack (in another room, for example), it might interfere with the product's ability to receive faxes.

### Setup for stand-alone fax

1. Unpack and set up the product.
2. Set the time, date, and fax header. See [Configure fax settings on page 97](#).
3. Set other settings as necessary to configure for the product environment.

### Configure fax settings

The product fax settings can be set from the control panel, from HP ToolboxFX, or from the embedded Web server. At the initial set-up process, the HP Fax Setup Wizard can be used to configure the settings.

In the United States and many other countries/regions, setting the time, date, and other fax header information is a legal requirement.

### Use the control panel to set the fax time, date, and header

To use the control panel to set the date, time, and header, complete the following steps:

1. At the control panel, press **Setup**.
2. Use the arrow buttons to select **System setup**, and then press **OK**.
3. Use the arrow buttons to select **Time/Date**. Press **OK**.
4. Use the arrow buttons to select the 12-hour clock or 24-hour clock, and then press **OK**.
5. Use the alphanumeric buttons to enter the current time.

6. Complete one of the following:
  - For the 12-hour clock, use the arrow buttons to move past the fourth character. Select **1** for a.m. or **2** for p.m. Press **OK**.
  - For the 24-hour clock, press **OK**.
7. Use the alphanumeric buttons to enter the current date. Use two digits to specify the month, day, and year. Press **OK**.
8. Use the arrow buttons to select **Fax setup**, then press **OK**.
9. Use the arrow buttons to select **Fax Header**, then press **OK**.
10. Use the alphanumeric buttons to enter your fax number and your company name or header, and then press **OK**.

---

 **NOTE:** The maximum number of characters for the fax number is 20; use up to 25 characters for the company name.

---

### Use HP Fax Setup Wizard to set the fax time, date, and header

If you completed the software installation, you are ready to send faxes from your computer. If you did not complete the fax setup process at the time you installed the software, you can complete it at any time by using the Fax Setup Wizard.

1. Click **Start**, and then click **Programs**.
2. Click **HP**, click the name of the product, and then click **HP Fax Setup Wizard**.
3. Follow the onscreen instructions in the HP Fax Setup Wizard to set the time, date, and fax header, as well as several other settings.

### Use of common localized letters in fax headers

When using the control panel to enter your name in the header or to enter a name for a one-touch key, speed-dial entry, or group-dial entry, press the appropriate alphanumeric button repeatedly until the letter that you need appears. Then, press the **>** button to select that letter and move to the next space. The following table shows which letters and numbers appear on each alphanumeric button.

Key number	Characters
1	1
2	A B C a b c 2
3	D E F d e f 3
4	G H I g h i 4
5	J K L j k l 5
6	M N O m n o 6
7	P Q R S p q r s 7
8	T U V t u v 8
9	W X Y Z w x y z 9
0	0
*	( ) + - . / , * & @ R W
#	space # ,

 **NOTE:** Use > to move the cursor on the control panel and use < to delete characters.

## Manage the phone book

You can store frequently dialed fax numbers or groups of fax numbers as speed dials or group-dial entries.

In the product phone book, a total of 120 entries are available for speed dials and group-dial entries. For example, if you program 100 of the entries as speed-dials, the remaining 20 can be used for group-dials.

 **NOTE:** Speed dials and group-dial entries are more easily programmed from HP ToolboxFX or the embedded Web server. For more information, see the HP ToolboxFX online Help or [Embedded Web server on page 153](#).

## Use phone-book data from other programs

 **NOTE:** Before a phone book from another program can be imported, you must use the export feature in that other program.

HP ToolboxFX can import contact information from other software program phone books. The following table shows which programs are supported for HP ToolboxFX.

Program	Description
Microsoft Outlook	<p>Personal Address Book (PAB) entries, Contacts entries, or both combined may be selected. Individuals and groups from the PAB are combined with individuals from Contacts only if the combined option is selected.</p> <p>If a Contacts entry has both a home and a business fax number, two entries will be displayed. The “name” of these two entries will be modified. “:(B)” will be added to the name in the business entry and “:(H)” will be added to the name in the home entry.</p>

Program	Description
	If a duplicate entry occurs (one from Contacts and one from the PAB with the same name and fax number), a single entry will be displayed. However, if an entry exists in the PAB with a duplicate in Contacts, and the Contacts entry has both a business and a home fax number, all three entries will be displayed.
Windows Address Book	The Windows Address Book (WAB), used by Outlook Express and Internet Explorer, is supported. If an individual has both a home and a business fax number, two entries will be displayed. The "name" of these two entries will be modified. ":(B)" will be added to the name in the business entry and ":(H)" will be added to the name in the home entry.
Goldmine	Goldmine version 4.0 is supported. HP ToolboxFX imports the file last used by Goldmine.
Symantec Act!	Act! versions 4.0 and 2000 are supported. HP ToolboxFX imports the database last used by Act!.

Complete the following steps to import a phone book:

1. Open HP ToolboxFX.
2. Click **Fax**, and then click **Fax Phone Book**.
3. Browse to the program phone book, and then click **Import**.

## Delete phone book

You can delete all speed dials and group-dial entries that are programmed in the product.

△ **CAUTION:** After speed dials and group-dial entries are deleted, they cannot be recovered.

1. On the control panel, press **Setup**.
2. Use the arrow buttons to select **Fax setup**, and then press **OK**.
3. Press **OK** to select **Phone Book**.
4. Use the arrow buttons to select **Delete All**, and then press **OK**.
5. Press **OK** to confirm the deletion.

## Special dialing symbols and options

You can insert pauses into a fax number that you are dialing or programming to a one-touch key, speed-dial entry, or group-dial entry. Pauses are often needed when dialing internationally or connecting to an outside line.

- **Insert a dialing pause:** Press **# (Pause)** repeatedly until a comma (,) appears on the control-panel display, indicating that the pause will occur at that point in the dialing sequence.
- **Insert a pause for dial tone:** Press **\* (Symbols)** repeatedly until **W** appears on the control-panel display to have the product wait for a dial tone before dialing the remainder of the telephone number.
- **Insert a hook flash:** Press **\* (Symbols)** repeatedly until **R** appears on the control-panel display to have the product perform a hook flash.



## Manage speed dials

### Create and edit speed dials

Speed dials 1 through 16 are also associated with their corresponding one-touch keys on the control panel. The one-touch keys can be used for speed dials or group-dial entries. A maximum of 50 characters can be entered for a single fax number.

---

 **NOTE:** To gain access to all of the speed dials, you must use the **Shift** button. Speed dials 9 through 16 are all available by pressing **Shift** and the associated one-touch key on the control panel.

---

Complete the following steps to program speed dials from the control panel:

1. On the control panel, press **Setup**.
2. Use the arrow buttons to select **Fax setup**, and then press **OK**.
3. Press **OK** to select **Phone Book**.
4. Press **OK** to select **Individual Setup**.
5. Press **OK** to select **Add**.
6. Use the alphanumeric buttons to specify the speed-dial entry number that you want to associate with this fax number, and then press **OK**. Selecting a number from 1 to 16 also associates the fax number with the corresponding one-touch key.
7. Use the alphanumeric buttons to enter the fax number. Include any pauses or other needed numbers, such as an area code, an access code for numbers outside a PBX system (usually a 9 or 0), or a long distance prefix.

---

 **NOTE:** When entering a fax number, press **Pause** until a comma (,) appears if you want to insert a pause in the dialing sequence, or press **\*** until **W** appears if you want the product to wait for a dial tone.

---

8. Press **OK**.
9. Use the alphanumeric buttons to enter a name for the fax number. To do so, repeatedly press the alphanumeric button for the letter that you need until the letter appears. (For a list of characters, see [Use of common localized letters in fax headers on page 98](#).)

---

 **NOTE:** To insert punctuation, press the asterisk (\*) button repeatedly until the character that you want appears, and then press the > button to go to the next space.

---

10. Press **OK** to save the information.
11. If you have more speed dials to program, repeat steps 1 through 10.

### Delete speed dials

1. On the control panel, press **Setup**.
2. Use the arrow buttons to select **Fax setup**, and then press **OK**.
3. Press **OK** to select **Phone Book**.
4. Press **OK** to select **Individual setup**.
5. Use the arrow buttons button to select **Delete**, and then press **OK**.

6. Use the alphanumeric buttons to enter the number of the speed-dial entry you want to delete, and then press **OK**.
7. Press **OK** to confirm the deletion.

## Manage group-dial entries

### Create and edit group-dial entries

1. Assign a speed-dial entry to each fax number that you want in the group. (For instructions, see [Create and edit speed dials on page 101.](#))
2. On the control panel, press **Setup**.
3. Use the arrow buttons to select **Fax setup**, and then press **OK**.
4. Press **OK** to select **Phone Book**.
5. Use the arrow buttons to select **Group setup**, and then press **OK**.
6. Use the arrow buttons to select **Add/Edit group**, and then press **OK**.
7. Use the alphanumeric buttons to enter the number that you want to associate with this group, and then press **OK**. Selecting 1 through 16 also associates the group with the corresponding one-touch key.
8. Use the alphanumeric buttons to enter a name for the group, and then press **OK**.
9. Press a one-touch key, and then press **OK** again to confirm the addition. Repeat this step for each group member you want to add.  
  
**-or-**  
  
Select **Phone Book**, and then select the speed-dial entry for the group member you want to add. Press **OK** to confirm the addition. Repeat this step for each group member you want to add.
10. When you are finished, press **OK**.
11. If you have more group-dial entries to assign, press **OK**, and then repeat steps 1 through 10.

### Delete group-dial entries

1. On the control panel, press **Setup**.
2. Use the arrow buttons to select **Fax setup**, and then press **OK**.
3. Press **OK** to select **Phone Book**.
4. Use the arrow buttons to select **Group setup**, and then press **OK**.
5. Use the arrow buttons to select **Delete group**, and then press **OK**.
6. Using the alphanumeric buttons, enter the number of the group-dial that you want to delete, and then press **OK**.
7. Press **OK** to confirm the deletion.

### Delete an individual from a group-dial entry

1. On the control panel, press **Setup**.
2. Use the arrow buttons to select **Fax setup**, and then press **OK**.
3. Press **OK** to select **Phone Book**.
4. Use the arrow buttons to select **Group setup**, and then press **OK**.
5. Use the arrow buttons to select **Del. # in group**, and then press **OK**.
6. Use the arrow buttons to select the individual that you want to delete from the group.
7. Press **OK** to confirm the deletion.
8. Repeat steps 6 and 7 to delete other individuals from the group.

**-or-**

Press **Cancel** if you are finished.



---

**NOTE:** Deleting a speed-dial entry also deletes that entry from any group-dial entries that included that speed-dial entry.

---

### Set fax polling

If someone else has set up a fax to be polled, you can request that the fax be sent to your product. (This is known as polling another machine).

1. On the control panel, press **Setup**.
2. Use the arrow buttons to select **Fax functions**, and then press **OK**.
3. Use the arrow buttons to select **Polling receive**, and then press **OK**.

The product dials the other fax machine and requests the fax.

### Security

The product includes a password feature that restricts access to many settings features while allowing basic functions to continue.

Private receive can be used to store faxes on the product until you are at the product to print them.

### Turn on password protection

To set up the product security password, complete the following steps:

1. On the control panel, press **Setup**.
2. Use the arrow buttons to select **System setup**, and then press **OK**.
3. Use the alphanumeric buttons to enter the product password, and then press **OK**.
4. To confirm the product password, use the alphanumeric buttons to re-enter the password, and then press **OK**.

5. Use the arrow buttons to select **Product security**, and then press **OK**.
6. Use the arrow buttons to select **On**, and then press **OK**.

### Turn on private receive feature

The password-protection feature must be turned on before the private-receive feature can be activated.

1. On the control panel, press **Setup**.
2. Use the arrow buttons to select **Fax setup**, and then press **OK**.
3. Use the alphanumeric buttons to enter the product security password, and then press **OK**.
4. To confirm the product security password, use the alphanumeric buttons to re-enter the product security password, and then press **OK**.
5. Use the arrow buttons to select **Fax Recv. setup**, and then press **OK**.
6. Use the arrow buttons to select **Private Receive**, and then press **OK**.
7. Use the arrow buttons to select **On**, and then press **OK**.

# Change fax settings

## Set the sound-volume settings

Control the volume of the fax sounds from the control panel. You can make changes to the following sounds:

- The fax sounds that are associated with incoming and outgoing faxes
- The ring for incoming faxes

The factory-set default for the fax-sounds volume is **Soft**.

## Set the fax-sounds (line-monitor) volume

Complete the following steps to change the fax-sounds volume.

1. Press **Volume** on the control panel.
2. Use the arrow buttons to select **Off**, **Soft**, **Medium**, or **Loud**.
3. Press **OK** to save the selection.

## Set the ring volume

When the product is initially receiving a call, a ring alert is audible. The ring duration length is based on the local telephone company ring-pattern length. The factory-set default for the ring volume is **Soft**.

1. Press **Setup**.
2. Use the arrow buttons to select **System setup**, and then press **OK**.
3. Use the arrow buttons to select **Volume settings**, and then press **OK**.
4. Use the arrow buttons to select **Ring volume**, and then press **OK**.
5. Use the arrow buttons to select **Off**, **Soft**, **Medium**, or **Loud**.
6. Press **OK** to save the selection.

## Send fax settings

### Set a dial prefix

A dial prefix is a number or group of numbers that are automatically added to the beginning of every fax number you enter at the control panel or from the software. The maximum number of characters for a dial prefix is 50.

The default setting is **Off**. You might want to turn this setting on and enter a prefix if, for example, you have to dial a number such as 9 to get a telephone line outside of your company telephone system. While this setting is activated, you can dial a fax number without the dial prefix by using manual dial. For instructions, see [Manual dial faxing on page 120](#).

1. On the control panel, press **Setup**.
2. Use the arrow buttons to select **Fax setup**, and then press **OK**.
3. Use the arrow buttons to select **Fax Send setup**, and then press **OK**.

4. Use the arrow buttons to select **Dial Prefix**, and then press **OK**.
5. Use the arrow buttons to select **On** or **Off**, and then press **OK**.
6. If you selected **On**, use the alphanumeric buttons to enter the prefix, and then press **OK**. You can use numbers, pauses, and dialing symbols.

### Set the dial-tone detection

Normally, the product begins dialing a fax number immediately. If you are using the product on the same line as your telephone, turn on the detect-dial-tone setting. This prevents the product from sending a fax while someone is on the telephone.

The factory-set default for detect dial tone is **On** for France and Hungary, and **Off** for all other countries/regions.

1. On the control panel, press **Setup**.
2. Use the arrow buttons to select **Fax setup**, and then press **OK**.
3. Use the arrow buttons to select **Fax Send setup**, and then press **OK**.
4. Use the arrow buttons to select **Detect dial tone**, and then press **OK**.
5. Use the arrow buttons to select **On** or **Off**, and then press **OK**.

### Set autoreodial

If the product was unable to send a fax because the receiving fax machine did not answer or was busy, the product attempts to redial based on the redial-on-busy, redial-on-no-answer, and redial-on-communication-error options. Use the procedures in this section to turn these options on or off.

#### Set the redial-on-busy option

If this option is turned on, the product redials automatically if it receives a busy signal. The factory-set default for the redial-on-busy option is **On**.

1. On the control panel, press **Setup**.
2. Use the arrow buttons to select **Fax setup**, and then press **OK**.
3. Use the arrow buttons to select **Fax Send setup**, and then press **OK**.
4. Use the arrow buttons to select **Redial if busy**, and then press **OK**.
5. Use the arrow buttons to select **On** or **Off**, and then press **OK**.

#### Set the redial-on-no-answer option

If this option is turned on, the product redials automatically if the receiving machine does not answer. The factory-set default for the redial-on-no-answer option is **Off**.

1. On the control panel, press **Setup**.
2. Use the arrow buttons to select **Fax setup**, and then press **OK**.
3. Use the arrow buttons to select **Fax Send setup**, and then press **OK**.

4. Use the arrow buttons to select **Redial-no answer**, and then press **OK**.
5. Use the arrow buttons to select **On** or **Off**, and then press **OK**.

### Set the redial-on-communication-error option

If this option is turned on, the product redials automatically if some sort of communication error occurs. The factory-set default for the redial-on-communication-error option is **On**.

1. On the control panel, press **Setup**.
2. Use the arrow buttons to select **Fax setup**, and then press **OK**.
3. Use the arrow buttons to select **Fax Send setup**, and then press **OK**.
4. Use the arrow buttons to select **Redial Comm Err.**, and then press **OK**.
5. Use the arrow buttons to select **On** or **Off**, and then press **OK**.

### Set light/dark and resolution

#### Set the default light/dark (contrast) setting

The contrast affects the lightness and darkness of an outgoing fax as it is being sent.

The default light/dark setting is the contrast that is normally applied to items that are being faxed. The slider is set to the middle as the default setting.

1. On the control panel, press **Setup**.
2. Use the arrow buttons to select **Fax setup**, and then press **OK**.
3. Use the arrow buttons to select **Fax Send setup**, and then press **OK**.
4. Use the arrow buttons to select **Def. Light/dark**, and then press **OK**.
5. Use the **<** button to move the slider to the left to make the fax lighter than the original, or use the **>** button to move the slider to the right to make the fax darker than the original.
6. Press **OK** to save the selection.

#### Set resolution settings

---

 **NOTE:** Increasing the resolution increases the fax size. Larger faxes increase the send time and could exceed the available memory in the product.

---

The factory-set default resolution setting is **Fine**.

Use this procedure to change the default resolution for all fax jobs to one of the following settings:

- **Standard:** This setting provides the lowest quality and the fastest transmission time.
- **Fine:** This setting provides a higher resolution quality than **Standard** that is usually appropriate for text documents.
- **Superfine:** This setting is best used for documents that mix text and images. The transmission time is slower than **Fine** but faster than **Photo**.
- **Photo:** This setting produces the best images, but greatly increases the transmission time.

### Set the default resolution setting

1. On the control panel, press **Setup**.
2. Use the arrow buttons to select **Fax setup**, and then press **OK**.
3. Use the arrow buttons to select **Fax Send setup**, and then press **OK**.
4. Use the arrow buttons to select **Def. Resolution**, and then press **OK**.
5. Use the arrow buttons to change the resolution setting.
6. Press **OK** to save the selection.

### Set the resolution for the current fax job

1. On the control panel, press **Resolution** to show the current resolution setting.
2. Use the arrow buttons to select the appropriate resolution setting.
3. Press **OK** to save the selection.

---

 **NOTE:** This procedure changes the fax resolution for the current fax job. For instructions about changing the default fax resolution, see [Set the default resolution setting on page 108](#).

**NOTE:** To change the fax contrast or glass-scan size, you must change the default settings. See [Set the default light/dark \(contrast\) setting on page 107](#) or [Set the default glass-size setting on page 108](#).

### Set the default glass-size setting

This setting determines which paper size the flatbed scanner scans when you send a fax from the scanner. The factory-set default is determined by the country/region in which you purchased the product.

1. On the control panel, press **Setup**.
2. Use the arrow buttons to select **Fax setup**, and then press **OK**.
3. Use the arrow buttons to select **Fax Send setup**, and then press **OK**.
4. Use the arrow buttons to select **Def. Glass size**, and then press **OK**.
5. Use the arrow buttons to select the correct paper size setting: **A4** or **Letter**.
6. Press **OK** to save the selection.

### Set tone-dialing or pulse-dialing

Use this procedure to set the product to tone-dialing or pulse-dialing mode. The factory-set default is **Tone**. Do not change this setting unless you know that the telephone line cannot use tone dialing.

1. On the control panel, press **Setup**.
2. Use the arrow buttons to select **Fax setup**, and then press **OK**.
3. Use the arrow buttons to select **Fax Send setup**, and then press **OK**.
4. Use the arrow buttons to select **Dialing Mode**, and then press **OK**.
5. Use the arrow buttons to select **Tone** or **Pulse**, and then press **OK** to save the selection.



---

 **NOTE:** The pulse-dialing option is not available in all countries/regions.

---

## Set billing codes

If the billing codes feature has been turned on, the user will be asked to enter a billing code for each fax. The billing code count is increased for each fax page that is sent. This includes all types of faxes except for poll-received, fax-forwarded, or computer-downloaded faxes. For an undefined group or a group-dial fax, the billing code count is increased for each successful fax that is sent to each destination. To print a report that shows the total for each billing code, see [Print the billing-code report on page 109](#).

The factory-set default for the billing-code setting is **Off**. The billing code can be any number from 1 through 250.

### Set the billing-code setting

1. On the control panel, press **Setup**.
2. Use the arrow buttons to select **Fax setup**, and then press **OK**.
3. Use the arrow buttons to select **Fax Send setup**, and then press **OK**.
4. Use the arrow buttons to select **Billing codes**, and then press **OK**.
5. Use the arrow buttons to select **On** or **Off**, and then press **OK**.

### Use billing codes

1. Load the document in the automatic document feeder (ADF) input tray or on the flatbed scanner.
2. On the control panel, enter the phone number manually, by speed-dial, or by group-dial entry.
3. Press **Start Fax**.
4. Enter the billing code, and then press **Start Fax**.

The fax job is sent and recorded in the billing-code report. For information about printing the billing-code report, see [Print the billing-code report on page 109](#).

### Print the billing-code report

The billing-code report is a printed list of all of the fax billing codes and the total number of faxes that have been billed to each code.

---

 **NOTE:** After this report is printed, all billing data is deleted.

---

1. On the control panel, press **Setup**.
2. Use the arrow buttons to select **Reports**, and then press **OK**.
3. Use the arrow buttons to select **Billing report**, and then press **OK**. The product exits the menu settings and prints the report.

## Receive fax settings

### Set or change number of rings-to-answer

When the answer mode is set to **Automatic**, the product rings-to-answer setting determines the number of times the telephone rings before the product answers an incoming call.

If the product is connected to a line that receives both fax and voice calls (a shared line) and that also uses an answering machine, you might need to adjust the rings-to-answer setting. The number of rings-to-answer for the product must be greater than the rings-to-answer on the answering machine. This allows the answering machine to answer the incoming call and record a message if it is a voice call. When the answering machine answers the call, the product listens to the call and automatically answers it if it detects fax tones.

The default setting for rings-to-answer is five for the U.S. and Canada, and two for other countries/regions.

### Use the rings-to-answer setting

Use the following table to determine the number of rings-to-answer to use.

Type of telephone line	Recommended rings-to-answer setting
Dedicated fax line (receiving only fax calls)	Set to a number of rings within the range shown on the control-panel display. (The minimum and maximum number of rings allowed varies by country/region.)
One line with two separate numbers and a ring-pattern service	One or two rings. (If you have an answering machine or computer voicemail for the other telephone number, make sure that the product is set to a greater number of rings than the answering system. Also, use the distinctive-ring feature to differentiate between voice and fax calls. See <a href="#">Set up distinctive ring on page 112.</a> )
Shared line (receiving both fax and voice calls) with only an attached telephone	Five rings or more.
Shared line (receiving both fax and voice calls) with an attached answering machine or computer voicemail	Two rings more than the answering machine or computer voicemail.

### Set the number of rings-to-answer

To set or change the number of rings-to-answer, use the following steps:

1. On the control panel, press **Setup**.
2. Use the arrow buttons to select **Fax setup**, and then press **OK**.
3. Use the arrow buttons to select **Fax Recv. setup**, and then press **OK**.
4. Use the arrow buttons to select **Rings to answer**, and then press **OK**.
5. Use the alphanumeric buttons to enter the number of rings-to-answer, and then press **OK**.

## Set the answer mode

Depending on the situation, set the product answer mode to **Automatic** or **Manual**. The factory-set default is **Automatic**.

- **Automatic:** In this answer mode, the product answers incoming calls after a specified number of rings or upon recognition of special fax tones. To specify the number of rings, see [Set the number of rings-to-answer on page 110](#).
- **TAM:** In this answer mode, the product has a telephone answering machine (TAM) attached to the line-out port. The product does not answer incoming calls, but listens for fax call tones after the TAM has answered the call.
- **Fax/Tel:** In this answer mode, the product answers an incoming call and determines if the call is a voice call or fax call. If the call is a fax call, the product receives the fax from the call. If the call is a voice call, the product generates an audible ring to indicate an incoming voice call that you must answer on an extension phone.
- **Manual:** In this answer mode, the product never answers calls. You must start the fax-receiving process yourself, either by pressing **Start Fax** on the control panel or by picking up a telephone that is connected to that line and dialing 1-2-3.

To set or change the answer mode, complete the following steps:

1. On the control panel, press **Setup**.
2. Use the arrow buttons to select **Fax setup**, and then press **OK**.
3. Use the arrow buttons to select **Fax Recv. setup**, and then press **OK**.
4. Press **OK** to select **Answer mode**.
5. Use the arrow buttons to select the answer mode, and then press **OK**.

The control-panel display shows the answer mode setting that you specified.

## Set fax forwarding

You can set your product to forward incoming faxes to another fax number. When the fax arrives at your product, it is stored in the memory. The product then dials the fax number that you have specified and sends the fax. If the product cannot forward a fax because of an error (for example, the number is busy) and repeated redial attempts are unsuccessful, your product prints the fax.

If the product runs out of memory while receiving a fax, it terminates the incoming fax and only forwards the pages and partial pages that have been stored in the memory.

When it is using the fax-forwarding feature, the product (rather than the computer) must be receiving the faxes, and the answer mode must be set to **Automatic**.

1. On the control panel, press **Setup**.
2. Use the arrow buttons to select **Fax setup**, and then press **OK**.
3. Use the arrow buttons to select **Fax Recv. setup**, and then press **OK**.
4. Use the arrow buttons to select **Forward fax**, and then press **OK**.

5. Use the arrow buttons to select **On** or **Off**, and then press **OK**.
6. If you turn on the fax-forwarding feature, use the alphanumeric buttons to specify the fax number where the fax is to be sent, and then press **OK** to save the selection.

## Set up distinctive ring

Ring-pattern or distinctive-ring service is available through some local telephone companies. The service allows you to have more than one telephone number on a single line. Each telephone number has a unique ring pattern, so that you can answer voice calls and the product can answer fax calls.

If you subscribe to a ring-pattern service with a telephone company, you must set the product to answer the correct ring pattern. Not all countries/regions support unique ring patterns. Contact the telephone company to determine if this service is available in your country/region.

---

 **NOTE:** If you do not have ring-pattern service and you change the ring-pattern settings to something other than the default, **All Rings**, the product might not be able to receive faxes.

---

The settings are as follows:

- **All Rings:** The product answers any calls that come through the telephone line.
- **Single:** The product answers any calls that produce a single-ring pattern.
- **Double:** The product answers any calls that produce a double-ring pattern.
- **Triple:** The product answers any calls that produce a triple-ring pattern.
- **Double&Triple:** The product answers any calls that produce a double-ring or triple-ring pattern.

To change ring patterns for call answering, complete the following steps:

1. On the control panel, press **Setup**.
2. Use the arrow buttons to select **Fax setup**, and then press **OK**.
3. Use the arrow buttons to select **Fax Recv. setup**, and then press **OK**.
4. Use the arrow buttons to select **Answer Ring Type**, and then press **OK**.
5. Use the arrow buttons to select the ring pattern that you want, and then press **OK**.
6. After product installation is complete, ask someone to send a fax to you in order to verify that the ring-pattern service is working correctly.

## Set up the computer to receive faxes

---

 **NOTE:** Receiving faxes by using a computer is not supported for Macintosh.

---

Receiving faxes to a computer is available only if a full software installation was performed during initial product setup.

---

To receive faxes to your computer, turn on the receive-to-PC setting in the software.

1. Open HP ToolboxFX.
2. Select the product.
3. Click **Fax**.

4. Click **Fax Tasks**.
5. Under **Fax Receive Mode**, select **Receive faxes to this computer**.

### Turn off the receive-to-PC setting from the control panel

The receive-to-PC setting can be activated only from one computer. If for any reason that computer is no longer available, you can use the following procedure to turn the receive-to-PC setting off from the control panel.

1. On the control panel, press **Setup**.
2. Use the arrow buttons to select **Fax functions**, and then press **OK**.
3. Use the arrow buttons to select **Stop Recv to PC**, and then press **OK**.

### Use autoreduction for incoming faxes

If the fit-to-page option is turned on, the product automatically reduces long faxes up to 75% to fit the information on the default paper size (for example, the fax is reduced from legal to letter size).

If the fit-to-page option is turned off, long faxes print at full size on multiple pages. The factory-set default for incoming fax autoreduction is **On**.

If you have the stamp-received faxes option turned on, you might also want to turn on autoreduction. This reduces the size of the incoming faxes slightly, and prevents the page-stamp from forcing a fax onto two pages.

---

 **NOTE:** Make sure that the default media size setting matches the size of the media that is loaded in the tray.

---

1. On the control panel, press **Setup**.
2. Use the arrow buttons to select **Fax setup**, and then press **OK**.
3. Use the arrow buttons to select **Fax Recv. setup**, and then press **OK**.
4. Use the arrow buttons to select **Fit to page**, and then press **OK**.
5. Use the arrow buttons to select **On** or **Off**, and then press **OK** to save the selection.

### Set the silence-detect mode

This setting controls whether or not you can receive faxes from older-model fax machines that do not emit a fax signal during fax transmissions. At the time of this publication, these silent-model fax machines represented very few of the fax machines in use. The default setting is **Off**. The silence-detect mode setting should be changed only if you regularly receive faxes from someone who uses an older-model fax machine.

1. On the control panel, press **Setup**.
2. Use the arrow buttons to select **Fax setup**, and then press **OK**.
3. Use the arrow buttons to select **Fax Recv. setup**, and then press **OK**.
4. Use the arrow buttons to select **Silence Detect**, and then press **OK**.
5. Use the arrow buttons to select **On** or **Off**, and then press **OK** to save the selection.

## Set the default fax reprint settings

The default fax reprint setting is **On**. To change this setting from the control panel, complete the following steps:

1. On the control panel, press **Setup**.
2. Use the arrow buttons to select **Fax setup**, and then press **OK**.
3. Use the arrow buttons to select **Fax Recv. setup**, and then press **OK**.
4. Use the arrow buttons to select **Reprint faxes**, and then press **OK**.
5. Use the arrow buttons to select **On** or **Off**, and then press **OK**.

## Automatic two-sided printing (duplexing) of received faxes

When **Print duplex** is **On**, all faxes received are printed two-sided. The factory-set default for printing faxes two-sided is **Off**.

### Set the print duplex setting for faxes

1. On the control panel, press **Setup**.
2. Use the arrow buttons to select **Fax setup**, and then press **OK**.
3. Use the arrow buttons to select **Fax Recv. setup**, and then press **OK**.
4. Use the arrow buttons to select **Print duplex**, and then press **OK**.
5. Use the arrow buttons to select **On** or **Off**, and then press **OK**.

## Create stamp-received faxes

The product prints the sender identification information at the top of each received fax. You can also choose to have your own header information included on each received fax to confirm the date and time that the fax was received. The factory-set default for stamp-received faxes is **Off**.

---

 **NOTE:** This option applies only to received faxes that the product prints.

---

1. On the control panel, press **Setup**.
2. Use the arrow buttons to select **Fax setup**, and then press **OK**.
3. Use the arrow buttons to select **Fax Recv. setup**, and then press **OK**.
4. Use the arrow buttons to select **Stamp faxes**, and then press **OK**.
5. Use the arrow buttons to select **On** or **Off**, and then press **OK** to save the selection.

## Block or unblock fax numbers

If you do not want to receive faxes from specific people or businesses, you can block as many as 30 fax numbers by using the control panel. When you block a fax number and someone from that number sends you a fax, the control-panel display indicates that the number is blocked, the fax does not print, and the fax is not saved in memory. Faxes from blocked fax numbers appear in the fax activity log with a “discarded” designation. You can unblock blocked fax numbers individually or all at one time.

---

 **NOTE:** The sender of a blocked fax is not notified that the fax failed.

---

To print a list of numbers that you have blocked or the fax activity log, see [Print individual fax reports on page 133](#).

Complete the following steps to block or unblock fax numbers by using the control panel:

1. On the control panel, press **Setup**.
2. Use the arrow buttons to select **Fax setup**, and then press **OK**.
3. Use the arrow buttons to select **Fax Recv. setup**, and then press **OK**.
4. Use the arrow buttons to select **Block faxes**, and then press **OK**.
5. To block a fax number, use the arrow buttons to select **Add entry**, and then press **OK**. Enter the fax number exactly as it appears in the header (including spaces), and then press **OK**. Enter a name for the blocked number, and then press **OK**.

To unblock a single fax number, use the arrow buttons to select **Delete entry**, and then press **OK**. Use the arrow buttons to select the fax number that you want to delete, and then press **OK** to confirm the deletions.

**-or-**

To unblock all blocked fax numbers, use the arrow buttons to select **Clear all**, and then press **OK**. Press **OK** again to confirm the deletions.

### **Make an extension telephone available to receive faxes**

With this setting turned on, you can alert the product to pick up the incoming fax call by pressing 1-2-3 sequentially on the telephone keypad. The default setting is **On**. Turn this setting off only if you use pulse dialing or if you have a service from your telephone company that also uses the 1-2-3 sequence. The telephone company service does not work if it conflicts with the product.

1. On the control panel, press **Setup**.
2. Use the arrow buttons to select **Fax setup**, and then press **OK**.
3. Use the arrow buttons to select **Fax Recv. setup**, and then press **OK**.
4. Use the arrow buttons to select **Extension Phone**, and then press **OK**.
5. Use the arrow buttons to select **On** or **Off**, and then press **OK** to save the selection.

# Use fax

## Fax software

### Supported fax programs

The PC fax program that came with the product is the only PC fax program that works with the product. In order to continue to use a PC fax program previously installed on the computer, it must be used with the modem that is already connected to the computer; it will not function through the product modem.

### Available cover-page templates

Several business and personal fax cover-page templates are available in the HP LaserJet Send Fax software program.

---

 **NOTE:** Cover-sheet templates cannot be altered. While fields within the templates may be edited, the templates themselves are fixed forms.

---

### Customize a fax cover sheet

1. Open the HP LaserJet Send Fax software program.
2. In the **Fax To** section, provide the recipient fax number, name, and company.
3. In the **Resolution** section, select a resolution setting.
4. In the **Include With Fax** section, select **Cover Page**.
5. Add more information in the **Notes** and **Subject** text boxes.
6. In the **Cover Page Template** drop-down box, select a template, and then select **Pages in Document Tray**.
7. Do one of the following:
  - Click **Send Now** to send the fax without previewing the cover page.
  - Click **Preview** to view the cover page prior to sending the fax.

### Cancel a fax

Use these instructions to cancel a single fax that is currently dialing or a fax that is being transmitted or received.

### Cancel the current fax

Press **Cancel** on the control panel. Any pages that have not been transmitted are canceled. Pressing **Cancel** also stops group-dial jobs.



## Cancel a pending fax job

Use this procedure to cancel a fax job in the following situations:

- The product is waiting to redial after encountering a busy signal, an unanswered call, or a communication error.
- The fax is scheduled to be sent at a future time.

Use the following steps to cancel a fax job by using the **Fax Job status** menu:

1. On the control panel, press **Setup**.
2. Press **OK** to select **Fax Job status**.
3. Use the arrow buttons to scroll through pending jobs until you reach the job that you want to clear.
4. Press **OK** to select the job that you want to cancel.
5. Press **OK** to confirm that you want to cancel the job.

## Delete faxes from memory

Use this procedure only if you are concerned that someone else has access to your product and might try to reprint faxes from the memory.

---

△ **CAUTION:** In addition to clearing the reprint memory, this procedure clears any fax that is currently being sent, unsent faxes that are pending redial, faxes that are scheduled to be sent at a future time, and faxes that are not printed or forwarded.

---

1. On the control panel, press **Setup**.
2. Use the arrow buttons to select **Fax functions**, and then press **OK**.
3. Use the arrow buttons to select **Clear saved faxes**, and then press **OK**.
4. Press **OK** to confirm the deletion.

## Use fax on a DSL, PBX, ISDN, or VoIP system

HP products are designed specifically for use with traditional analog phone services. They are not designed to work on DSL, PBX, ISDN lines, or VoIP services, but they might work with the proper setup and equipment.

---

 **NOTE:** HP recommends discussing DSL, PBX, ISDN, and VoIP setup options with the service provider.

---

The HP LaserJet product is an analog device that is not compatible with all digital phone environments (unless a digital-to-analog converter is used). HP does not guarantee that the product will be compatible with digital environments or digital-to-analog converters.

## DSL

A digital subscriber line (DSL) uses digital technology over standard copper telephone wires. This product is not directly compatible with digital signals. However, if the configuration is specified during DSL setup, the signal can be separated so that some of the bandwidth is used to transmit an analog signal (for voice and fax) while the remaining bandwidth is used to transmit digital data.

---

 **NOTE:** Not all faxes are compatible with DSL services. HP does not guarantee that the product will be compatible with all DSL service lines or providers.

---

The DSL modem requires a high-pass filter. The service provider typically provides a low-pass filter, for normal telephone wiring.

---

 **NOTE:** Contact the DSL provider for more information or for assistance.

---

## PBX

The product is an analog device that is not compatible in all digital phone environments. Digital-to-analog filters or converters may be needed for faxing functionality. If faxing issues occur in a PBX environment, it might be necessary to contact the PBX provider for assistance. HP does not guarantee that the product will be compatible with digital environments or digital-to-analog converters.

Contact the PBX provider for more information and for assistance.

## ISDN

Contact the ISDN provider for more information and for assistance.

## VoIP

Voice over internet protocol (VoIP) services are often not compatible with fax machines unless the provider explicitly states that it supports fax over IP services.

If the product experiences problems getting a fax to work on a VoIP network, verify that all cables and settings are correct. Decreasing the fax-speed setting might allow the product to send a fax over a VoIP network.

If faxing problems continue, contact the VoIP provider.

## Send a fax

### Fax from the flatbed scanner

1. Make sure that the automatic document feeder (ADF) contains no media.
2. Lift the flatbed scanner cover.
3. Place the original document face-down on the flatbed scanner with the upper-left corner of the document at the lower-right corner of the glass.

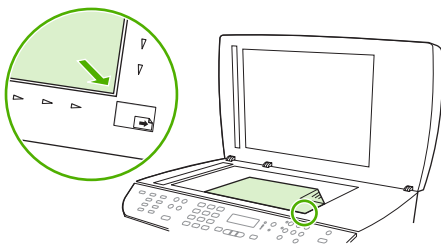

4. Gently close the lid.
5. Use the alphanumeric buttons on the control panel to dial the number.

**-or-**

If the fax number you are calling has been assigned to a one-touch key, press that key.

-or-

If the fax number you are calling has a speed dial or group-dial entry, press **Phone Book**, use the alphanumeric buttons to specify the speed dial or group-dial entry, and then press **OK**.

6. On the control panel, press **Start Fax**.

The control-panel display shows the following message: **Send from glass? 1=Yes 2=No**.

7. Press **1** to select **Yes**. The control-panel display shows the following message: **Load page: X Press OK**, where X is the page number.
8. Press **OK**. After scanning the page, the product control-panel display shows the following message: **Another page? 1=Yes 2=No**.
9. If you have more pages to scan, press **1** to select **Yes**, and then repeat step 3 for each page of the fax job.

-or-

If you are finished, press **2** to select **No**, and then go to the next step.

## Fax from the automatic document feeder (ADF)

 **NOTE:** The ADF capacity is up to 50 sheets of 80 g/m<sup>2</sup> or 20 lb media.

 **CAUTION:** To prevent damage to the product, do not use an original that contains correction tape, correction fluid, paper clips, or staples. Also, do not load photographs, small originals, or fragile originals into the ADF. Use the flatbed glass to scan these items.

1. Insert the top-end of the stack of originals into the ADF input tray, with the media stack face-up and the first page to be copied on top of the stack.

If the media is longer than Letter- or A4-sized paper, pull out the ADF input tray extension to support the media.

2. Slide the stack into the ADF until it does not move any farther.

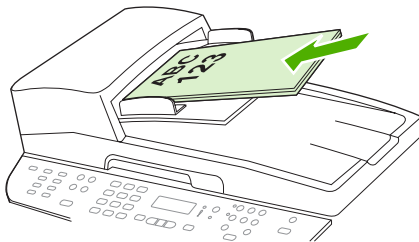

**Document loaded** appears on the control-panel display.

3. Adjust the media guides until they are snug against the media.

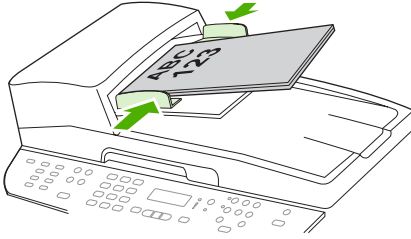

4. Use the alphanumeric buttons on the control panel to dial the number.

-or-

If the fax number you are calling has been assigned to a one-touch key, press that key.

-or-

If the fax number you are calling has a speed dial or group-dial entry, press **Phone Book**, use the alphanumeric buttons to specify the speed dial or group-dial entry, and then press **OK**.

5. On the control panel, press **Start Fax**. The product starts the fax job.

## Fax a two-sided original

To fax a two-sided document, use the scanner glass. See [Fax from the flatbed scanner on page 118](#).

## Manual dial faxing

Usually, the product dials after you press **Start Fax**. At times, however, you might want the product to dial each number as you press it. For example, if you are charging your fax call to a calling card, you might need to dial the fax number, wait for the acceptance tone of your telephone company, and then dial the calling card number. When dialing internationally, you might need to dial part of the number and then listen for dial tones before continuing to dial.

### Dial manually with the automatic document feeder (ADF)

1. Load the document into the automatic document feeder (ADF) input tray.
2. On the control panel, press **Start Fax**.
3. Begin dialing.

 **NOTE:** The product dials the number as you press each digit. This allows you to wait for pauses, dial tones, international-access tones, or calling-card-acceptance tones before continuing to dial.

### Dial manually with the flatbed scanner

1. On the control panel, press **Start Fax**.  
The control-panel display shows the following message: **Send from glass? 1=Yes 2=No**.
2. Press **1** to select **Yes**. The control-panel display shows the following message: **Load page: X Press OK**, where X is the page number.
3. Scan a page into memory by placing the sheet print-side-down on the flatbed scanner and pressing **OK**. After scanning the page, the product control-panel display shows the following message: **Another page? 1=Yes 2=No**.

4. If you have more pages to scan, press **1** to select **Yes**, and then repeat step 3 for each page of the fax job.

**-or-**

If you are finished, press **2** to select **No**, and then go to the next step.

5. When all pages are scanned into memory, begin dialing. The product dials the number as you press each digit. This allows you to wait for pauses, dial tones, international access tones, or calling card acceptance tones before continuing to dial.

### Send a fax to a group manually (ad hoc faxing)

Use the following instructions to send a fax to a group of recipients that has not been assigned a group-dial entry:

1. Load the document into the automatic document feeder (ADF) input tray or on the flatbed scanner.
2. Use the alphanumeric buttons.

**-or-**

If the fax number that you are calling has been assigned a speed-dial entry, press **Phone Book**, use the alphanumeric buttons to specify the speed-dial entry, and then press **OK**.

3. Press **OK**.
4. To continue dialing numbers, repeat steps 2 and 3.

**-or-**

If you are finished dialing numbers, go to the next step.

5. Press **Start Fax**. If the pages that you want to send are in the ADF, then faxing begins automatically.
6. If the product ADF sensor detects that no document is loaded into the ADF input tray, **Send from glass? 1=Yes 2=No** appears on the control-panel display. To send the fax from the flatbed scanner, press **1** to select **Yes**, and then press **OK**.

Load Page: X Press OK appears on the control-panel display.

7. If you have already placed the document on the flatbed scanner, press **OK** (or place the document on the flatbed scanner and then press **OK**).

After scanning the page, **Another page? 1=Yes 2=No** appears on the control-panel display.

8. If you have more pages to scan, press **1** to select **Yes**, and then repeat step 7 for each page of the fax job.

**-or-**

If you are finished, press **2** to select **No**.

The product sends the fax to each fax number. If a number in the group is busy or does not answer, the product redials that number based on the redial setting. If all redial attempts fail, the product updates the fax activity log by adding the error, and then it proceeds to the next number in the group.

## Redial manually

1. Load the document into the automatic document feeder (ADF) input tray or onto the flatbed scanner.
2. On the control panel, press **Redial**.
3. Press **Start Fax**. If the pages that you want to send are in the ADF, then faxing begins automatically.
4. If the product ADF sensor detects that no document is loaded into the ADF input tray, **Send from glass? 1=Yes 2=No** appears on the control-panel display. To send the fax from the flatbed scanner, press **1** to select **Yes**, and then press **OK**.

After you press **OK**, **Load page: X Press OK** appears on the control-panel display.

5. If you have already placed the document on the flatbed scanner, press **OK** (or place the document on the flatbed scanner and then press **OK**).

After scanning the page, **Another page? 1=Yes 2=No** appears on the control-panel display.

6. If you have more pages to scan, press **1** to select **Yes**, and then repeat step 5 for each page of the fax job.

**-or-**

If you are finished, press **2** to select **No**.

The product sends the fax to the number that it redialed. If the number is busy or does not answer, the product redials the number based on its redial setting. If all redial attempts fail, the product updates the fax activity log by adding the error.

## Use speed dials and group-dial entries

### Send a fax by using a speed dial

1. Load the document into the automatic document feeder (ADF) input tray or on the flatbed scanner.
2. Press the one-touch key for the speed dial.

**-or-**

Press **Phone Book**, use the alphanumeric buttons to specify the speed-dial entry, and then press **OK**.

3. Load the document into the automatic document feeder (ADF) input tray or on the flatbed scanner.
4. Press **Start Fax**. If the pages that you want to send are in the ADF, then faxing begins automatically.
5. If the product ADF sensor detects that no document is loaded into the ADF input tray, **Send from glass? 1=Yes 2=No** appears on the control-panel display. To send the fax from the flatbed scanner, press **1** to select **Yes**, and then press **OK**.

After you press **OK**, **Load page: X Press OK** appears on the control-panel display.

6. If you have already placed the document on the flatbed scanner, press **OK** (or place the document on the flatbed scanner and then press **OK**).

After scanning the page, **Another page? 1=Yes 2=No** appears on the control-panel display.

7. If you have more pages to scan, press **1** to select **Yes**, and then repeat step 5 for each page of the fax job.

**-or-**

If you are finished, press **2** to select **No**.

When the last page of the fax has exited the product, you can start sending another fax, copying, or scanning.

You can assign a speed dial to numbers that you use regularly. See [Create and edit speed dials on page 101](#). If you have electronic phone books available, you might be able to use them to select recipients. Electronic phone books are generated by using third-party software programs.

### Send a fax by using a group-dial entry

1. Load the document into the automatic document feeder (ADF) input tray or on the flatbed scanner.
2. Press the one-touch key for the group.

**-or-**

Press **Phone Book**, use the alphanumeric buttons to specify the group-dial entry, and then press **OK**.

3. Press **Start Fax**. If the pages that you want to send are in the ADF, then faxing begins automatically.
4. If the product ADF sensor detects that no document is loaded into the ADF input tray, **Send from glass? 1=Yes 2=No** appears on the control-panel display. To send the fax from the flatbed scanner, press **1** to select **Yes**, and then press **OK**.

After you press **OK**, **Load page: X Press** appears on the control-panel display.**OK**.

5. If you have already placed the document on the flatbed scanner, press **OK** (or place the document on the flatbed scanner and then press **OK**).

After scanning the page, **Another page? 1=Yes 2=No** appear on the control-panel display.

6. If you have more pages to scan, press **1** to select **Yes**, and then repeat step 5 for each page of the fax job.

**-or-**

If you are finished, press **2** to select **No**.

The product scans the document into memory and sends the fax to each number specified. If a number in the group is busy or does not answer, the product redials the number based on its redial setting. If all redial attempts fail, the product updates the fax activity log with the error and proceeds to the next number in the group.

## Send a fax from the software

This section contains basic instructions for sending faxes by using the software that came with the product. All other software-related topics are covered in the software Help, which can be opened from the software-program **Help** menu.

You can fax electronic documents from a computer if you meet the following requirements:

- The product is connected directly to the computer or connected to the computer over a TCP/IP network.
- The product software is installed on the computer.
- The computer operating system is Microsoft Windows XP, Windows Vista, Mac OS X v10.3, or Mac OS X v10.4.

### Send a fax from the software (Windows XP or Vista)

The procedure to send a fax varies according to your specifications. The most typical steps follow.

1. Click **Start**, click **Programs** (or **All Programs** in Windows XP), and then click **Hewlett-Packard**.
2. Click **HP LaserJet product**, and then click **Send fax**. The fax software appears.
3. Enter the fax number of one or more recipients.
4. Load the document in the automatic document feeder (ADF) input tray.
5. Include a cover page. (This step is optional.)
6. Click **Send Now**.

### Send a fax from the software (Mac OS X v10.3)

1. Load the document into the automatic document feeder (ADF) input tray or the flatbed scanner.
2. Open HP Director and click **Fax**. The fax software appears.
3. Select **Fax** from the **Print** dialog.
4. Enter the fax number of one or more recipients.
5. Include a cover page (this step is optional).
6. Click **Fax**.

### Send a fax from the software (Mac OS X v10.4)

Using Mac OS X v10.4, you can choose between two methods of sending faxes from the product software.

To send a fax by using HP Director complete the following steps:

1. Load the document into the automatic document feeder (ADF) input tray or the flatbed scanner.
2. Open HP Director by clicking the icon in the dock, and then click **Fax**. The Apple print dialog appears.
3. Select **Fax PDF** from the **PDF** pop-up menu.
4. Enter the fax number of one or more recipients under **To**.



5. Select the product under **Modem**.
6. Click **Fax**.

To send a fax by printing to a fax driver, complete the following steps:

1. Open the document that you want to fax.
2. Click **File** and then click **Print**.
3. Select **Fax PDF** from the **PDF** pop-up menu.
4. Enter the fax number of one or more recipients under **To**.
5. Select the product under **Modem**.
6. Click **Fax**.

### Send a fax from a third-party software program, such as Microsoft Word (all operating systems)

1. Open a document in a third-party program.
2. Click the **File** menu, and then click **Print**.
3. Select the fax print driver from the printer driver drop-down list. The fax software appears.
4. Complete one of the following procedures:
  - **Windows**
    - a. Enter the fax number of one or more recipients.
    - b. Include a cover page. (This step is optional.)
    - c. Include any pages loaded at the product. (This step is optional.)
    - d. Click **Send Now**.
  - **Macintosh**
    - a. **Mac OS X v10.3:** Select **Fax** from the **Print** dialog.  
-or-  
**Mac OS X v10.4:** Select **Fax PDF** from the **PDF** pop-up menu.
    - b. Enter the fax number of one or more recipients.
    - c. **Mac OS X v10.3:** Include a cover page (this step is optional).  
-or-  
**Mac OS X v10.4:** Select the product under **Modem**.
    - d. Click **Fax**.

## Send a fax by dialing from a downstream phone

Occasionally, you might want to dial a fax number from a telephone that is connected to the same line as the product. For example, if you are sending a fax to a person whose device is in the manual receive mode, you can precede the fax with a voice call to let that person know that the fax is coming.



---

**NOTE:** The telephone must be connected to the product "telephone" port (  ).

---

1. Load the document into the automatic document feeder (ADF) input tray.



---

**NOTE:** You cannot use the flatbed scanner when sending a fax by dialing from an extension telephone.

---

2. Pick up the handset of a telephone that is connected to the same line as the product. Dial the fax number by using the telephone keypad.
3. When the recipient answers, instruct the person to start the fax machine.
4. When you hear the fax tones, press **Start Fax**, wait until **Connecting** appears on the control-panel display, and then hang up the telephone.

## Send a delayed fax

Use the product control panel to schedule a fax to be sent automatically at a future time to one or more people. When this procedure is completed, the product scans the document into memory and then returns to the Ready state.



---

**NOTE:** If the product cannot transmit the fax at the scheduled time, that information is indicated on the fax error report (if that option is turned on) or recorded in the fax activity log. The transmittal might not be initiated because the fax-sending call is not answered, or because a busy signal stops the redial attempts.

---

If a fax has been scheduled to be sent at a future time but it requires updating, send the additional information as another job. All faxes that are scheduled to go to the same fax number at the same time are delivered as individual faxes.

1. Load the document into the automatic document feeder (ADF) input tray or onto the flatbed scanner.
2. On the control panel, press **Setup**.
3. Use the arrow buttons until **Fax functions** appears, and then press **OK**.
4. Use the arrow buttons until **Send fax later** appears, and then press **OK**.
5. Use the alphanumeric buttons to enter the time.
6. If the product is set to the 12-hour time mode, use the arrow buttons to move the cursor past the fourth character to set A.M. or P.M. Select **1** for A.M. or select **2** for P.M., and then press **OK**.

**-or-**

If the product is set to the 24-hour time mode, press **OK**.

7. Use the alphanumeric buttons to enter the date, and then press **OK**.

**-or-**

Accept the default date by pressing **OK**.

8. Enter the fax number, enter the speed dial, or press the one-touch key.

---

 **NOTE:** This feature does not support undefined (ad hoc) groups.

---

9. Press **OK** or **Start Fax**. The product scans the document into memory and sends it at the designated time.

## Use access codes, credit cards, or calling cards

To use access codes, credit cards, or calling cards, dial manually to allow for pauses and dialing codes. See [Manual dial faxing on page 120](#).

## Send faxes internationally

To send a fax to an international destination, dial manually to allow for pauses and international dialing codes. See [Manual dial faxing on page 120](#).

## Receive a fax

When the product receives a fax transmission, it prints the fax (unless the private-receive feature is enabled) and also stores it automatically to flash memory.

## Print a stored fax (when private receive feature is on)

To print stored faxes, you must provide the private-receive PIN. Once the product prints the stored faxes, the faxes are deleted from memory.

1. On the control panel, press **Setup**.
2. Use the arrow buttons to select **Fax setup**, and then press **OK**.
3. Use the alphanumeric buttons to enter the product security PIN, and then press **OK**.
4. Use the arrow buttons to select **Fax Recv. setup**, and then press **OK**.
5. Use the arrow buttons to select **Private receive**, and then press **OK**.
6. Use the arrow buttons to select **Print faxes**, and then press **OK**.

## Reprint a fax

If you want to reprint a fax because the print cartridge was empty or if the fax was printed on the wrong type of media, you can try to reprint it. The amount of memory that is available determines the actual number of faxes that are stored for reprinting. The most recent fax prints first; the oldest fax that is in storage prints last.

These faxes are stored continuously. Reprinting them does not clear them from the memory. To clear these faxes from the memory, see [Delete faxes from memory on page 117](#).

1. On the control panel, press **Setup**.
2. Use the arrow buttons to select **Fax functions**, and then press **OK**.
3. Use the arrow buttons to select **Reprint last**, and then press **OK**. The product begins reprinting the most recently printed fax.

---

 **NOTE:** To stop the printing at any time, press **Cancel**.

---

---

△ **CAUTION:** If the **Reprint faxes** setting is set to **Off**, misprinted or faded faxes cannot be reprinted.

---

## Receive faxes when fax tones are audible on the phone line

If you have a telephone line that receives both fax and telephone calls, and you hear fax tones when you answer the telephone, you can start the receiving process in one of two ways:

- If you are close to the product, press **Start Fax** on the control panel.
- When you answer any telephone connected to the line (an extension telephone) and hear fax tones, the product should begin answering the call automatically. If not, press 1-2-3 in sequence on the telephone keypad, listen for fax transmission sounds, and then hang up.

---

 **NOTE:** In order for the second method to work, the extension telephone setting must be set to **Yes**. See [Make an extension telephone available to receive faxes on page 115](#) to check or change the setting.

---

## View a fax that was sent to your computer

In order to view faxes on a computer, the product must be configured to receive faxes to the computer. See [Set up the computer to receive faxes on page 112](#).

1. Open HP ToolboxFX.
2. Select the product.
3. Click **Fax**.
4. Click **Fax Receive Log**.
5. In the **Fax Image** column, click the “view” link of the fax that you want to view.

---

 **NOTE:** Receiving faxes by using a computer is not supported for Macintosh.

---

# Solve fax problems

## Fax error messages

Alert and warning messages appear temporarily and might require the user to acknowledge the message by pressing **OK** to resume or by pressing **Cancel** to cancel the job. With certain warnings, the job might not complete or the print quality might be affected. If the alert or warning message is related to printing and the auto-continue feature is on, the product will attempt to resume the printing job after the warning has appeared for 10 seconds without acknowledgement.

## Alert and warning message tables

**Table 10-1 Alert and warning messages**

Control panel message	Description	Recommended action
<b>Comm. error</b>	A fax communication error occurred between the product and the sender or receiver.	Allow the product to retry sending the fax. Unplug the product telephone cord from the wall, plug in a telephone, and try making a call. Plug the product phone cord into a jack for another phone line.  Try a different phone cord.  If the error persists, contact HP. See <a href="http://www.hp.com/support/LJM2727">www.hp.com/support/LJM2727</a> or the support flyer that came in the product box.
<b>Fax delayed – Send memory full</b>	Fax memory is full.	Cancel the fax by pressing <b>OK</b> or <b>Cancel</b> . Resend the fax. You might need to send the fax in multiple sections if the error occurs again.
<b>Fax is busy Canceled send</b>	The fax line to which you were sending a fax was busy. The product has canceled sending the fax.	Call the recipient to ensure that the fax machine is on and ready.  Check that you are dialing the correct fax number.  Check that the <b>Redial if busy</b> option is enabled.  Check for a dial tone on the phone line by pressing <b>Start Fax</b> .  Make sure that the phone is working by disconnecting the product, plugging in a telephone to the phone line, and making a voice call.  Plug the product phone cord into a jack for another phone line, and then try sending the fax again.  Try a different phone cord.  If the error persists, contact HP. See <a href="http://www.hp.com/support/LJM2727">www.hp.com/support/LJM2727</a> or the support flyer that came in the product box.
<b>Fax is busy Redial pending</b>	The fax line to which you were sending a fax was busy. The product automatically redials the busy number. See <a href="#">Set autoredial on page 106</a> .	Allow the product to retry sending the fax.  Call the recipient to ensure that the fax machine is on and ready.

**Table 10-1 Alert and warning messages (continued)**

Control panel message	Description	Recommended action
		<p>Check that you are dialing the correct fax number.</p> <p>Check for a dial tone on the phone line by pressing <a href="#">Start Fax</a>.</p> <p>Make sure that the phone is working by disconnecting the product, plugging in a telephone to the phone line, and making a voice call.</p> <p>Plug the product phone cord into a jack for another phone line, and try sending the fax again.</p> <p>Try a different phone cord.</p> <p>If the error persists, contact HP. See <a href="http://www.hp.com/support/LJM2727">www.hp.com/support/LJM2727</a> or the support flyer that came in the product box.</p>
<b>Fax memory full Canceling recv.</b>	During the fax transmission, the product ran out of memory. Only the pages that fit into memory will be printed.	<p>Print all of the faxes, and then have the sender resend the fax. Have the sender divide the fax job into multiple jobs before resending. Cancel all fax jobs or clear the faxes from memory. See <a href="#">Delete faxes from memory on page 117</a>.</p> <p>Note: Adding a memory DIMM does not help resolve this issue.</p>
<b>Fax memory full Canceling send</b>	During the fax job, the memory filled. All pages of the fax have to be in memory for a fax job to work correctly. Only the pages that fit into memory were sent.	<p>Print all received faxes or wait until all pending faxes are sent.</p> <p>Ask the sender to send the fax again.</p> <p>Cancel all fax jobs or clear the faxes from memory. See <a href="#">Delete faxes from memory on page 117</a>.</p>
<b>Fax recv. error</b>	An error occurred while trying to receive a fax.	<p>Ask the sender to resend the fax.</p> <p>Try faxing back to the sender or another fax machine.</p> <p>Check for a dial tone on the phone line by pressing <a href="#">Start Fax</a>.</p> <p>Check that the telephone cord is securely connected by unplugging and replugging the cord.</p> <p>Make sure that you are using the telephone cord that came with the product.</p> <p>Make sure that the phone is working by disconnecting the product, plugging in a telephone to the phone line, and making a voice call.</p> <p>Decrease the fax speed. See <a href="#">Change the fax speed on page 135</a>. Ask the sender to resend the fax.</p>

**Table 10-1 Alert and warning messages (continued)**

Control panel message	Description	Recommended action
		<p>Turn off error-correction mode. See <a href="#">Set the fax-error-correction mode on page 135</a>. Ask the sender to resend the fax.</p> <p>Connect the product to a different phone line.</p> <p>If the error persists, contact HP. See <a href="http://www.hp.com/support/LJM2727">www.hp.com/support/LJM2727</a> or the support flyer that came in the product box.</p>
<b>Fax Send error</b>	An error occurred while trying to send a fax.	<p>Try resending the fax.</p> <p>Try faxing to another fax number.</p> <p>Check for a dial tone on the phone line by pressing <b>Start Fax</b>.</p> <p>Check that the telephone cord is securely connected by unplugging and replugging the cord.</p> <p>Make sure that you are using the telephone cord that came with the product.</p> <p>Make sure that the phone is working by disconnecting the product, plugging in a telephone to the phone line, and making a voice call.</p> <p>Connect the product to a different phone line.</p> <p>Set the fax resolution to <b>Standard</b> instead of the default of <b>Fine</b>. See <a href="#">Set resolution settings on page 107</a>.</p> <p>If the error persists, contact HP. See <a href="http://www.hp.com/support/LJM2727">www.hp.com/support/LJM2727</a> or the support flyer that came in the product box.</p>
<b>Group dial not allowed in group</b>	The speed-dial code that you typed is programmed for a group. Adding a group-dial to another group-dial is not allowed.	Add one-touch buttons (programmed as an individual speed dial) or speed-dial codes to a group-dial.
<b>Invalid entry</b>	Invalid data or response.	Correct the entry.
<b>No Dial Tone</b>	The product could not detect a dial tone.	<p>Check for a dial tone on the phone line by pressing <b>Start Fax</b>.</p> <p>Unplug the telephone cord from both the product and the wall and replug the cord.</p> <p>Make sure that you are using the telephone cord that came with the product.</p> <p>Unplug the product telephone cord from the wall, plug in a telephone, and try making a voice call.</p> <p>Plug the product phone cord into a jack for another phone line. See <a href="#">Connect to a telephone line on page 95</a>.</p> <p>If the error persists, contact HP. See <a href="http://www.hp.com/support/LJM2727">www.hp.com/support/LJM2727</a> or the support flyer that came in the product box.</p>

**Table 10-1 Alert and warning messages (continued)**

Control panel message	Description	Recommended action
<b>No document sent</b>	The product did not scan any pages, or it did not receive any pages from the computer to transmit a fax.	Try sending the fax again.
<b>No fax answer Redial pending</b>	The receiving fax line did not answer. The product attempts to redial after a few minutes.	Allow the product to retry sending the fax. Call the recipient to ensure that the fax machine is on and ready. Check that you are dialing the correct fax number. If the product continues to redial, unplug the product telephone cord from the wall, plug in a telephone, and try making a voice call. Plug the product phone cord into a jack for another phone line. Try a different phone cord. If the error persists, contact HP. See <a href="http://www.hp.com/support/LJM2727">www.hp.com/support/LJM2727</a> or the support flyer that came in the product box.
<b>No fax answer. Canceled send</b>	Attempts to redial a fax number failed, or the "Redial-no answer" option was turned off.	Call the recipient to ensure that the fax machine is on and ready. Check that you are dialing the correct fax number. Check that the redial option is enabled. Unplug the telephone cord from both the product and the wall and replug the cord. Unplug the product telephone cord from the wall, plug in a telephone, and try making a voice call. Plug the product phone cord into a jack for another phone line. If the error persists, contact HP. See <a href="http://www.hp.com/support/LJM2727">www.hp.com/support/LJM2727</a> or the support flyer that came in the product box.
<b>No fax detected</b>	The product answered the incoming call but did not detect that a fax machine was calling.	Allow the product to retry receiving the fax. Try a different phone cord. Plug the product phone cord into a jack for another phone line. If the error persists, contact HP. See <a href="http://www.hp.com/support/LJM2727">www.hp.com/support/LJM2727</a> or the support flyer that came in the product box.

## Fax memory is retained when there is a loss of power

The HP LaserJet M2727 mfp flash memory protects against data loss when a power failure occurs. Other fax devices store fax pages in either normal RAM or short-term RAM. Normal RAM immediately



loses data when power is lost, while short-term RAM loses data about 60 minutes after a power failure occurs. Flash memory can maintain its data for years without power applied.

## Fax logs and reports

Use the following instructions to print fax logs and reports:

### Print all fax reports

Use this procedure to print all of the following reports at one time:

- Fax activity log
  - Phone book report
  - Configuration report
  - Usage page
  - Block-fax list
  - Billing report (if the option is turned on)
1. On the control panel, press **Setup**.
  2. Use the arrow buttons to select **Reports**, and then press **OK**.
  3. Use the arrow buttons to select **Fax Reports**, and then press **OK**.
  4. Use the arrow buttons to select **All fax reports**, and then press **OK**. The product exits the menu settings and prints the reports.

### Print individual fax reports

Use the control panel to print the following fax logs and reports:

- **Fax activity log:** Provides a chronological history of the last 40 faxes that were received, sent, or deleted, and any errors that occurred.
  - **Phone book report:** Lists the fax numbers that are assigned to the phone book entries, including speed dials and group-dial entries.
  - **Block-fax list:** Lists the fax numbers that are blocked from sending faxes to the product.
  - **Last call report:** Provides information about the last fax sent from or received at the product.
1. On the control panel, press **Setup**.
  2. Use the arrow buttons to select **Reports**, and then press **OK**.
  3. Use the arrow buttons to select **Fax Reports**, and then press **OK**.
  4. Use the arrow buttons to select the report to be printed, and then press **OK**. The product exits the menu settings and prints the report.

---

 **NOTE:** If you selected **Fax Activity log** and pressed **OK**, press **OK** again to select **Print log now**. The product exits the menu settings and prints the log.

---

### Set the fax activity log to print automatically

You can decide whether or not you want the fax log to print automatically after every 40 entries. The factory-set default is **On**. Use the following steps to set the fax activity log to print automatically:

1. On the control panel, press **Setup**.
2. Use the arrow buttons to select **Reports**, and then press **OK**.
3. Use the arrow buttons to select **Fax Reports**, and then press **OK**.
4. Use the arrow buttons to select **Fax Activity log**, and then press **OK**.
5. Use the arrow buttons to select **Auto Log Print**, and then press **OK**.
6. Use the arrow buttons to select **On**, and then press **OK** to confirm the selection.

### Set the fax error report

A fax error report is a brief report that indicates the product experienced a fax job error. It can be set to print after the following events:

- Every fax error (the factory-set default)
- Send fax error
- Receive fax error
- Never

---

 **NOTE:** If you select **Never**, you will have no indication that a fax failed to be transmitted unless you print a fax activity log.

---

1. On the control panel, press **Setup**.
2. Use the arrow buttons to select **Reports**, and then press **OK**.
3. Use the arrow buttons to select **Fax Reports**, and then press **OK**.
4. Use the arrow buttons to select **Fax Error report**, and then press **OK**.
5. Use the arrow buttons to select the option for when you want the fax error reports to be printed.
6. Press **OK** to save the selection.

### Set the fax confirmation report

A confirmation report is a brief report that indicates the product successfully sent or received a fax job. It can be set to print after the following events:

- Every fax job
- Send fax
- Receive fax
- Never (the factory-set default)

1. On the control panel, press **Setup**.
2. Use the arrow buttons to select **Reports**, and then press **OK**.
3. Use the arrow buttons to select **Fax Reports**, and then press **OK**.
4. Use the arrow buttons to select **Fax Confirmation**, and then press **OK**.
5. Use the arrow buttons to select the option for when you want the fax error reports to be printed.
6. Press **OK** to save the selection.

## Include the first page of each fax on the fax confirmation, fax error, and last call reports

If this option is turned on and the page image still exists in the product memory, the fax configuration, fax error, and last call reports include a thumbnail (50% reduction) of the first page of the most recent fax that was sent or received. The factory-set default for this option is **On**.

1. On the control panel, press **Setup**.
2. Use the arrow buttons to select **Reports**, and then press **OK**.
3. Use the arrow buttons to select **Fax Reports**, and then press **OK**.
4. Use the arrow buttons to select **Include 1st page**, and then press **OK**.
5. Use the arrow buttons to select **On**, and then press **OK** to confirm the selection.

## Change error correction and fax speed

### Set the fax-error-correction mode

Usually, the product monitors the signals on the telephone line while it is sending or receiving a fax. If the product detects an error during the transmission and the error-correction setting is **On**, the product can request that the portion of the fax be resent. The factory-set default for error correction is **On**.

You should turn off error correction only if you are having trouble sending or receiving a fax, and you are willing to accept the errors in the transmission. Turning off the setting might be useful when you are trying to send a fax overseas or receive one from overseas, or if you are using a satellite telephone connection.

1. On the control panel, press **Setup**.
2. Use the arrow buttons to select **Fax setup**, and then press **OK**.
3. Use the arrow buttons to select **All faxes**, and then press **OK**.
4. Use the arrow buttons to select **Error correction**, and then press **OK**.
5. Use the arrow buttons to select **On** or **Off**, and then press **OK** to save the selection.

### Change the fax speed

The fax-speed setting is the modem protocol that the product uses to send faxes. It is the worldwide standard for full-duplex modems that send and receive data across telephone lines at up to 33,600 bits per second (bps). The factory-set default for the fax-speed setting is **High (V.34)**.

You should change the setting only if you are having trouble sending a fax to or receiving a fax from a particular device. Decreasing the fax speed might be useful when you are trying to send a fax overseas, or receive one from overseas, or if you are using a satellite telephone connection.

1. On the control panel, press **Setup**.
2. Use the arrow buttons to select **Fax setup**, and then press **OK**.
3. Use the arrow buttons to select **All faxes**, and then press **OK**.
4. Use the arrow buttons to select **Fax Speed**, and then press **OK**.
5. Use the arrow buttons to select a speed setting, and then press **OK**.

## Problems sending faxes

Problem	Cause	Solution
The document stops feeding in the middle of faxing.	The maximum length of a page that you can load is 381 mm (15 inches). Faxing of a longer page stops at 381 mm (15 inches).	Print the document on shorter media.  If no jam exists and less than one minute has elapsed, wait a moment before pressing <b>Cancel</b> . If a jam exists, remove the jam. Then, resend the job.
	If the item is too small, it can jam inside the automatic document feeder (ADF).	Use the flatbed scanner. The minimum page size for the ADF is 127 x 127 mm (5 x 5 inches).  If a jam exists, remove the jam. Then, resend the job.
Faxes stop during sending.	The receiving fax machine might be malfunctioning.	Try sending to another fax machine.
	The telephone line might not be working.	Do one of the following: <ul style="list-style-type: none"> <li>● Turn up the volume on the product, and then press <b>Start Fax</b> on the control panel. If you hear a dial tone, the telephone line is working.</li> <li>● Disconnect the product from the jack in the wall, and then connect a telephone to the jack. Try to make a telephone call to verify that the telephone line is working.</li> </ul>
	A communication error might be interrupting the fax job.	Change the redial-on-communication-error setting to <b>On</b> .

Problem	Cause	Solution
The product is receiving faxes but is not sending them.	If the product is on a digital system, the system might be generating a dial tone that the product cannot detect.	Disable the detect-dial-tone setting. If the error persists, contact the system service provider.
	A poor telephone connection might exist.	Try again later.
	The receiving fax machine might be malfunctioning.	Try sending to another fax machine.
	The telephone line might not be working.	Do one of the following: <ul style="list-style-type: none"> <li>Turn up the volume on the product and press <b>Start Fax</b> on the control panel. If a dial tone exists, the telephone line is working.</li> <li>Disconnect the product from the telephone jack and connect a telephone. Try to make a telephone call to verify that the telephone line is working.</li> </ul>
Outgoing fax calls continue to be dialed.	The product automatically redials a fax number if the redial options are set to <b>On</b> .	To stop the product from redialing a fax, press <b>Cancel</b> . Or change the redial setting.
Sent faxes are not arriving at the receiving fax machine.	The receiving fax machine might be off or might have an error condition, such as being out of paper.	Call the recipient to verify that the fax machine is on and ready to receive faxes.
	The originals might be incorrectly loaded.	Verify that the original documents are correctly loaded into the ADF input tray or flatbed scanner.
	A fax might be in memory because it is waiting to redial a busy number, other jobs that are ahead of it are waiting to be sent, or the fax is set up for a delayed send.	If a fax job is in memory for any of these reasons, an entry for the job appears in the fax log. Print the fax activity log and check the <b>Status</b> column for jobs that show a <b>Pending</b> designation.
Sent faxes include a block of gray shading at the end of each page.	The glass-fax size might be set incorrectly.	Verify that the setting is correct.
Sent faxes have data missing from the end of each page.	The glass-fax size might be set incorrectly.	Verify that the setting is correct.
The control panel shows a low-memory error.	The fax might be too large, or the resolution might be too high.	Try one of the following: <ul style="list-style-type: none"> <li>Divide a large fax into smaller sections, and then fax them individually.</li> <li>Clear stored faxes to make more memory available for outgoing faxes.</li> <li>Configure the outgoing fax as a delayed fax, and then verify that it will send completely.</li> <li>Make sure that the product is using the lowest resolution setting (<b>Standard</b>).</li> </ul>

## Problems receiving faxes

Use the table in this section to solve problems that might occur when receiving faxes.

 **NOTE:** Use the fax cord that came with the product in order to ensure that the product functions correctly.

Problem	Cause	Solution
The product cannot receive faxes from an extension telephone.	The extension-telephone setting might be disabled.	Change the extension-telephone setting.
	The fax cord might not be securely connected.	Verify that the fax cord is securely connected between the telephone jack and the product (or another device that is connected to the product). Press 1-2-3 in sequence, wait for three seconds, and then hang up.
	The product dialing mode might be incorrectly set, or the extension phone might be incorrectly set.	Verify that the product dialing mode is set to <b>Tone</b> . Verify that the extension phone is set up for tone dialing as well.
The product is not answering incoming fax calls.	The answer mode might be set to <b>Manual</b> .	If the answer mode is set to <b>Manual</b> , the product does not answer calls. Start the fax-receiving process manually.
	The rings-to-answer setting might not be set correctly.	Check the rings-to-answer setting to verify that it is set properly.
	The answer-ring pattern feature might be turned on, but you do not have the service, or you do have the service and the feature is not set correctly.	Check the answer-ring pattern feature to verify that it is set properly.
	The fax cord might not be correctly connected, or the fax cord is not working.	See the getting started guide to check the installation. Verify that you are using the fax cord that came with the product.
	The product might not be able to detect incoming fax tones because the answering machine is playing a voice message.	Re-record the answering machine message, leaving at least two seconds of silence at the beginning of the message.
	Too many devices might be connected to the telephone line.	Do not attach more than three devices to the line. Remove the last device that was connected and determine whether the product works. If not, continue removing devices one at a time and retry after removing each one.
	The telephone line might not be working.	Do one of the following: <ul style="list-style-type: none"> <li>● Increase the volume on the product, and then press <b>Start Fax</b> on the control panel. If a dial tone exists, the telephone line is working.</li> <li>● Disconnect the product from the telephone jack, and then connect a telephone. Try to make a telephone call to verify that the telephone line is working.</li> </ul>

Problem	Cause	Solution
The product is not answering incoming fax calls.	A voice-messaging service might be interfering with the product as it attempts to answer calls.	<p>Do one of the following:</p> <ul style="list-style-type: none"> <li>• Disable the messaging service.</li> <li>• Get a telephone line that is dedicated to fax calls.</li> <li>• Set the product answer mode to <b>Manual</b>. In manual mode, you must start the fax-receive process yourself.</li> <li>• Leave the product set to automatic mode and lower the rings-to-answer setting for the product to a number less than the rings-to-answer setting for the voice mail. The product will answer all incoming calls.</li> </ul>
	The product might be out of paper and the memory is full.	Refill the media input tray. Press <b>OK</b> . The product prints all of the faxes it has saved in memory and then resumes answering fax calls.
Faxes are not printing.	The media input tray is empty.	Load media. Any faxes that are received while the input tray is empty are stored in memory and will print after the tray has been refilled.
	The receive-to-PC option might be selected, and faxes are being received by the computer.	Check to determine whether the computer is receiving faxes.
	The product has encountered an error.	Check the control panel for an error message, and then see <a href="#">Fax error messages on page 129</a> .
Faxes are printing on two pages instead of one.	The autoreduction setting might not be set correctly.	Turn on the autoreduction setting.
	The incoming faxes might have been sent on larger media.	Adjust the autoreduction setting to allow larger pages to be printed on one page.
Received faxes are too light, are blank, or have poor print quality.	The product ran out of toner while printing a fax.	The product stores the most recently printed faxes. (The amount of memory that is available determines the actual number of faxes stored for reprinting.) As soon as possible, replace the print cartridge, and then reprint the fax.
	The fax that was sent was too light.	Contact the sender and have the sender resend the fax after altering the contrast settings.

## Performance problems

Problem	Cause	Solution
Faxes are transmitting or being received very slowly.	The fax might be very complex, such as one with many graphics.	Complex faxes take longer to be sent or received. Breaking longer faxes into multiple jobs and decreasing the resolution can increase the transmission speed.
	The receiving fax machine might have a slow modem speed.	The product sends the fax only at the fastest modem speed that the receiving fax machine can accept.
	The resolution at which the fax was sent or is being received might be very high.	To receive the fax, call and ask the sender to lower the resolution and resend the fax. To send the fax, lower the resolution and resend the fax.
	The telephone line might be experiencing line noise.	Hang up and resend the fax. Have the telephone company check the telephone line.  If the fax is being sent via a digital phone line, contact the service provider.
	The fax is being sent via an international call.	Allow more time to transmit fax jobs internationally.
	The original document has a colored background.	Reprint the original document with a white background, and then resend the fax.
The fax activity logs or fax call reports are printing at inappropriate times.	The fax activity log or fax call reports settings are not correct.	Print a configuration page and check when the reports print.
The product sounds are too loud or too soft.	The volume setting might not be adjusted correctly.	Adjust the product volume setting.



---

# 11 Manage and maintain the product

- [Information pages](#)
- [HP ToolboxFX](#)
- [Embedded Web server](#)
- [Use HP Web Jetadmin software](#)
- [Security features](#)
- [Use the convenience stapler \(HP LaserJet M2727nfs mfp only\)](#)
- [Manage supplies](#)

# Information pages

Information pages reside within the product memory. These pages help diagnose and solve problems with the product.

 **NOTE:** If the product language was not correctly set during installation, you can set the language manually so the information pages print in one of the supported languages. Change the language by using the **System setup** menu on the control panel or the embedded Web server. See [Control panel on page 9](#).

Page description	How to print the page
<b>Configuration page</b> Shows the current settings and product properties.	<ol style="list-style-type: none"><li>1. On the product control panel, press <b>Setup</b>.</li><li>2. Use the arrow buttons to select <b>Reports</b>, and then press <b>OK</b>.</li><li>3. Use the arrow buttons to select <b>Config report</b>, and then press <b>OK</b>.</li></ol> <p>A second page also prints. On that page, the <b>Fax Settings</b> section provides details about the product fax settings.</p>
<b>Supplies status page</b> Shows the remaining life of the HP print cartridge, the estimated pages remaining, the number of pages printed, and other supplies information.	<ol style="list-style-type: none"><li>1. On the product control panel, press <b>Setup</b>.</li><li>2. Use the arrow buttons to select <b>Reports</b>, and then press <b>OK</b>.</li><li>3. Use the arrow buttons to select <b>Supplies Status</b>, and then press <b>OK</b>.</li></ol>
<b>PCL, PCL 6, or PS font list</b> Shows which fonts are currently installed in the device.	<ol style="list-style-type: none"><li>1. On the product control panel, press <b>Setup</b>.</li><li>2. Use the arrow buttons to select <b>Reports</b>, and then press <b>OK</b>.</li><li>3. Use the arrow buttons to select <b>PCL font list</b>, <b>PS font list</b>, or <b>PCL6 font list</b>, and then press <b>OK</b>.</li></ol>
<b>Demo page</b> Contains examples of text and graphics.	<ol style="list-style-type: none"><li>1. On the product control panel, press <b>Setup</b>.</li><li>2. Use the arrow buttons to select <b>Reports</b>, and then press <b>OK</b>.</li><li>3. Use the arrow buttons to select <b>Demo page</b>, and then press <b>OK</b>.</li></ol>
<b>Event log</b>	You can print the event log from HP ToolboxFX, the embedded Web server, or HP Web Jetadmin. See <a href="#">HP ToolboxFX on page 144</a> , <a href="#">Embedded Web server on page 153</a> , or the Web Jetadmin Help.
<b>Usage page</b> Shows a page count for each size of paper printed, the number of one-sided (simplex) or two-sided (duplex) pages, and the average percentage of coverage.	<ol style="list-style-type: none"><li>1. On the product control panel, press <b>Setup</b>.</li><li>2. Use the arrow buttons to select <b>Reports</b>, and then press <b>OK</b>.</li><li>3. Use the arrow buttons to select <b>Usage page</b>, and then press <b>OK</b>.</li></ol>

Page description	How to print the page
<p><b>Menu map</b></p> <p>Shows the control-panel menus and available settings.</p>	<ol style="list-style-type: none"> <li>1. On the product control panel, press <a href="#">Setup</a>.</li> <li>2. Use the arrow buttons to select <b>Reports</b>, and then press <a href="#">OK</a>.</li> <li>3. Use the arrow buttons to select <b>Menu structure</b>, and then press <a href="#">OK</a>.</li> </ol>
<p><b>Network report</b></p> <p>Shows the product network settings.</p>	<ol style="list-style-type: none"> <li>1. On the product control panel, press <a href="#">Setup</a>.</li> <li>2. Use the arrow buttons to select <a href="#">Reports</a>, and then press <a href="#">OK</a>.</li> <li>3. Use the arrow buttons button to select <b>Network report</b>, and then press <a href="#">OK</a>.</li> </ol>
<p><b>Fax reports</b></p>	<p>For information about fax logs and reports, see <a href="#">Fax logs and reports on page 133</a>.</p>

# HP ToolboxFX

HP ToolboxFX is a program that you can use to complete the following tasks:

- Check the product status.
- Configure the product settings.
- View troubleshooting information.
- View online documentation.

You can view HP ToolboxFX when the product is directly connected to a computer or when it is connected to the network. You must perform the recommended full software installation to use HP ToolboxFX.

## View HP ToolboxFX

Open HP ToolboxFX in one of these ways:

- In the Windows system tray or on your desktop, double-click the HP ToolboxFX icon.
- On the Windows **Start** menu, click **Programs** (or **All Programs** in Windows XP), click **HP**, click **HP LaserJet M2727**, and then click **HP ToolboxFX**.

## Status

The HP ToolboxFX **Status** tab contains links to the following main pages:

- **Device Status.** View product status information. This page indicates product conditions such as a jam or an empty tray. After you correct a problem with the product, click **Refresh status** to update the product status.
- **Supplies Status.** View detailed supplies information such as the estimated percent of life remaining in the print cartridge and the number of pages that have been printed with the current print cartridge. This page also has links to order supplies and to find recycling information.
- **Device Configuration.** View a detailed description of the current product configuration, including the amount of memory installed and whether optional trays are installed.
- **Network Summary.** View a detailed description of the current network configuration, including the IP address and network status.
- **Print Info Pages.** Print the configuration page and various other information pages that are available for the product, such as the supplies status page and the demo page.
- **Event Log.** View a history of product errors. The most recent error is at the top of the list.

## Event log

The event log is a four-column table where the product events are logged for your reference. The log contains codes that correspond to the error messages that appear on the product control-panel display. The number in the Page Count column specifies the total number of pages that the product had printed when the error occurred. The event log also contains a brief description of the error. For more information about error messages, see [Control-panel messages on page 170](#).

## Alerts

The HP ToolboxFX **Alerts** tab contains links to the following main pages:

- **Set up Status Alerts** . Set up the product to send you pop-up alerts for certain events, such as low toner levels.
- **Set up E-mail Alerts**. Set up the product to send you e-mail alert messages for certain events, such as low toner levels.

### Set up status alerts

Use HP ToolboxFX to set up the product so that it issues pop-up alerts to your computer when certain events occur. Events that trigger alerts include jams, low levels of toner in HP print cartridges, non-HP print cartridge in use, empty input trays, and specific error messages.

Select the pop-up format, the tray icon format, or both for the alerts. The pop-up alerts only appear when the product is printing from the computer on which you set up the alerts.

---

 **NOTE:** You must click **Apply** before the changes take effect.

---

### Set up e-mail alerts

Use HP ToolboxFX to configure up to two e-mail addresses to receive alerts when certain events occur. You can specify different events, such as a low cartridge or a paper jam, for each e-mail address. Enter the information for the e-mail server that will send out the e-mail alert messages for the product.

---

 **NOTE:** You must click **Apply** before the changes take effect.

---

## Fax

Use the HP ToolboxFX **Fax** tab to perform fax tasks from your computer. The **Fax** tab contains links to the following main pages:

- **Fax Tasks**. Perform such tasks as sending a fax or clearing the fax memory, or set the fax receive mode.
- **Fax Phone Book**. Add, edit, or delete entries in the product phone book.
- **Fax Send Log**. View all of the recent faxes that have been sent from the product.
- **Fax Receive Log**. View all of the recent faxes that have been received by the product.
- **Block Faxes**. Add, delete, or view fax numbers that are blocked.
- **Fax Data Properties**. Manage the space used to store faxes on your computer. These settings apply only if you have chosen to send or receive faxes remotely from your computer.

## Fax tasks

The following three options are available when receiving a fax:

- Print the fax. You can also select an option to have a message appear on your computer to notifying you when the fax was printed.
- Receive the fax on your computer. You can also select an option to have a message appear on your computer to notifying you when the fax arrives. If the fax machine is connected to multiple computers, only one computer can be designated to receive faxes.
- Forward the fax to another fax machine.

For more information about fax tasks, see [Fax on page 93](#).

---

 **NOTE:** You must click **Apply** before the changes take effect.

---

## Fax phone book

Use the HP ToolboxFX fax phone book to add and remove individuals or groups on your speed-dial list, import phone books from a variety of sources, and update and maintain the contact list.

- To add an individual contact to the speed-dial list, select the row of the speed dial number that you want to specify. Type the contact name in the **Contact name** window. Type the fax number in the **Fax number** window. Click **Add**.
- To add a group of contacts to the speed-dial list, select the row of the speed-dial number that you want to specify. Click **Add Group**. Double-click a contact name from the list on the left to move it to the group list on the right, or select a name on the left and then click the appropriate arrow to move it to the group list on the right. You can also use those two methods to move names from right to left. When you have created a group, type a name in the **Group name** window, and then click **OK**.
- To edit an existing individual speed-dial entry, click anywhere on the row containing the contact name to select it, and then click **Update**. Type changes in the appropriate windows, and then click **OK**.
- To edit an existing group-speed-dial entry, click anywhere on the row containing the group name to select it, and then click **Update Group**. Make any required changes, and then click **OK**.
- To delete an entry from the speed-dial list, select the item, and then click **Delete**.
- To move speed dial entries, select the entry and then click **Move**, or select **Move** and then specify the entry in the dialog box. Either select **Next empty row** or specify the number of the row where you want to move the entry.

---

 **NOTE:** If you specify a row that is occupied, the new entry will overwrite the existing entry.

---

- To import contacts from a phone book that exists in Lotus Notes, Outlook, or Outlook Express, click **Import/Export Phone Book**. Select the **Import** option, and then click **Next**. Select the appropriate software program, navigate to the appropriate file, and then click **Finish**. To export contacts from a phone book, click **Import/Export Phone Book**. Select the **Export** option, and then click **Next**. Enter the file name or browse to the file to which you want to export contacts, and then click **Finish**. You can also select individual entries from the phone book instead of importing the entire phone book.
- To delete all entries, click **Delete All**, and then click **Yes**.

In addition to numerical digits, the following are valid characters for fax numbers:

- (
- )
- +
- -
- \*
- #
- R
- W
- .
- ,
- <space>

---

 **NOTE:** You must click **Apply** before the changes take effect.

---

For more information about faxes, see [Fax on page 93](#).

## Fax send log

The HP ToolboxFX fax send log lists all recently sent faxes and information about them, including the date and time sent, job number, fax number, page count, and the results.

Click any column heading in the fax send log to re-sort the information in that column in ascending or descending order.

The **Results** column provides the fax status. If the fax attempt was unsuccessful, this column provides a description of why the fax was not sent.

For more information about faxes, see [Fax on page 93](#).

## Fax receive log

The HP ToolboxFX fax receive log provides a list of all recently received faxes and information about them including the date and time received, job number, fax number, page count, results, and an abbreviated fax image.

The fax receive log can be used to block future faxes. Check the **Block Fax** box next to a received fax listed on the log.

When a computer that is connected to the product receives a fax, the fax contains a **View** link. Clicking this link opens a new page that provides information about the fax.

Click on any column heading in the fax receive log to re-sort the information in that column in ascending or descending order.

The **Results** column provides the fax status. If the fax attempt was unsuccessful, this column provides a description of why the fax was not received.

---

 **NOTE:** You must click **Apply** before the changes take effect.

---

For more information about faxes, see [Fax on page 93](#).

## Block Faxes

**Block Faxes** provides a list of all numbers that are blocked. Add, modify, or delete blocked fax numbers on this tab.

## Help

The HP ToolboxFX **Documentation** tab contains links to the following main pages:

- **Troubleshooting**
- **Animated demonstrations**
- **User Guide.** View information about the product usage, warranty, specifications, and support. The user guide is available in both HTML and PDF format.



## System Settings

The HP ToolboxFX **System Settings** tab contains links to the following main pages:

- **Device Information.** View information about the product, such as the product description and a contact person.
- **Paper Handling.** Change the product paper-handling settings, such as default paper size and default paper type.
- **Print Quality.** Change the product print-quality settings.
- **Paper Types.** Change the product mode settings for each media type, such as letterhead, prepunched, or glossy paper.
- **System Setup.** Change the product system settings, such as product language and jam recovery.
- **Service.** Gain access to various procedures required to maintain the product.
- **Device Polling.** Change the product polling settings, which determine how often HP ToolboxFX collects data from the product.
- **Save/Restore Settings.** Save the current settings for the product to a file on the computer. Use this file to load the same settings onto another product or to restore these settings to this product at a later time.
- **Password.** Set, change, or clear the product security password (see [Turn on password protection on page 103](#)).

## Device information

The HP ToolboxFX Device information page stores data about the product for future reference. The information that you type in these fields appears on the Configuration page. You can type any character in each of these fields.

---

 **NOTE:** You must click **Apply** before the changes take effect.

---

## Paper handling

Use the HP ToolboxFX paper-handling options to configure the default settings. These are the same options that are available on the product control-panel. For more information, see [Control panel on page 9](#).

Three options are available for handling print jobs when the product is out of media:

- Select **Wait for paper to be loaded**.
- Select **Cancel** from the **Paper out action** drop-down list to cancel the print job.
- Select **Override** from the **Paper out time** drop-down list to send the print job to another paper tray.

The **Paper out time** field specifies how long the product waits before acting on the selections. You can specify from 0 to 3600 seconds.

---

 **NOTE:** You must click **Apply** before the changes take effect.

---

## Print quality

Use the HP ToolboxFX print-quality options to improve the appearance of print jobs. These are the same options that are available on the product control panel. For more information, see [Control panel on page 9](#).

The four options provided for controlling print quality are resolution, REt (Resolution Enhancement technology), print density, and EconoMode.

- **Resolution.** Select 600 resolution for average print jobs and Fast Res 1200 for higher-quality print jobs. Select ProRes 1200 for the highest-quality print job, but a longer printing time.
- **REt.** You can turn on REt, which HP provides for improved print quality.
- **Print density.** For increased print density, select a higher number. For decreased print density, select a lower number.
- **EconoMode.** Turn EconoMode on when you are printing average print jobs. EconoMode is a feature that allows the product to use less toner per page. Selecting this option might extend the life of the toner supply and might reduce cost per page. However, it will also reduce print quality. The printed image is lighter, but it is adequate for printing drafts or proofs. HP does not recommend full-time use of EconoMode. If EconoMode is used full-time, it is possible that the toner supply will outlast the mechanical parts in the print cartridge. If print quality begins to degrade under these circumstances, you will need to install a new print cartridge, even if there is toner supply remaining in the cartridge.

---

 **NOTE:** You must click **Apply** before the changes take effect.

---

## Paper types

Use the HP ToolboxFX **Paper types** options to configure print modes that correspond to the various media types. Select **Restore Modes** to reset all modes to the factory settings.

---

 **NOTE:** You must click **Apply** before the changes take effect.

---

## System setup

Use the HP ToolboxFX system settings options to configure global settings for copy, fax, scan, and print, such as jam recovery and auto-continue.

---

 **NOTE:** You must click **Apply** before the changes take effect.

---

## Service

During the printing process, paper, toner and dust particles can accumulate inside the product. Over time, this buildup can cause print-quality problems such as toner specks or smearing. HP ToolboxFX provides an easy method for cleaning the paper path. For more information, see [Clean the paper path from HP ToolboxFX on page 162](#).

## Device polling

You can turn off HP ToolboxFX device polling to reduce network traffic, but doing so also disables some HP ToolboxFX features: pop-up alerts, fax log updates, the ability to receive faxes to this computer, and scanning using the **Scan To** button.

---

 **NOTE:** You must click **Apply** before the changes take effect.

---

## Print Settings

The HP ToolboxFX **Print Settings** tab contains links to the following main pages:

- **Printing.** Change the default product print settings, such as number of copies and paper orientation.
- **PCL5e.** View and change the PCL5 settings.
- **PostScript.** View and change the PS settings.

## Printing

Use the HP ToolboxFX printing settings options to configure the settings for all print functions. These are the same options that are available on the product control panel. For more information, see [Control panel on page 9](#).

---

 **NOTE:** You must click **Apply** before the changes take effect.

---

## PCL 5e

Use the PCL 5 options to configure the settings when you are using the PCL5 print personality. These are the same options that are available on the **PCL5** menu on the control panel.

---

 **NOTE:** You must click **Apply** before the changes take effect.

---

## PostScript

Use the PostScript option when you are using the HP postscript level 3 emulation print personality. When the **Print PostScript error** option is turned on, the PostScript error page automatically prints when HP postscript level 3 emulation errors occur.

---

 **NOTE:** You must click **Apply** before the changes take effect.

---

## Network Settings

The network administrator can use the HP ToolboxFX **Network Settings** tab to control the network-related settings for the product when it is connected to an IP-based network.

# Embedded Web server

This product is equipped with an embedded Web server (EWS), which provides access to information about product and network activities. A Web server provides an environment in which web programs may run, much in the same way that an operating system, such as Windows, provides an environment for programs to run on a computer. The output from these programs can then be displayed by a Web browser, such as Microsoft Internet Explorer, Safari, or Netscape Navigator.

An “embedded” Web server resides on a hardware device (such as an HP LaserJet product) or in firmware, rather than as software that is loaded on a network server.

The advantage of an EWS is that it provides an interface to the product that anyone with a network-connected product and computer can use. There is no special software to install or configure, but you must have a supported Web browser on the computer. To gain access to the EWS, type the IP address for the product in the address line of the browser. (To find the IP address, print a configuration page. For more information about printing a configuration page, see [Information pages on page 142.](#))

---

 **NOTE:** For Macintosh operating systems, you can use the EWS over a USB connection after installing the Macintosh software included with the product.

---

## Features

The EWS allows you to view product and network status and manage printing functions from a computer. With the EWS, you can complete the following tasks:

- View product status information
- Determine the remaining life on all supplies and order new ones
- View and change part of the product configuration
- View and print some internal pages
- Select the language in which to display the EWS pages
- View and change network configuration
- Set, change, or clear the product security password (see [Turn on password protection on page 103](#)).

---

 **NOTE:** Changing network settings in the EWS might disable some of product software or features.

---

## Use HP Web Jetadmin software

HP Web Jetadmin is a Web-based software solution for remotely installing, monitoring, and troubleshooting network-connected peripherals. The intuitive browser interface simplifies cross-platform management of a wide range of devices, including HP and non-HP devices. Management is proactive, allowing network administrators the ability to resolve issues before users are affected. Download this free, enhanced-management software at [www.hp.com/go/webjetadmin\\_software](http://www.hp.com/go/webjetadmin_software).

To obtain plug-ins to HP Web Jetadmin, click **plug-ins**, and then click the **download** link that is next to the name of the plug-in that you want. The HP Web Jetadmin software can automatically notify you when new plug-ins are available. On the **Product Update** page, follow the directions to automatically connect to the HP Web site.

If installed on a host server, HP Web Jetadmin is available to any client through a supported Web browser, such as Microsoft Internet Explorer 6.0 for Windows or Netscape Navigator 7.1 for Linux. Browse to the HP Web Jetadmin host.

---

 **NOTE:** Browsers must be Java-enabled. Browsing from an Apple PC is not supported.

---

## Security features

### Secure the embedded Web server

Use the EWS to set a password.

1. Open the EWS, and then click the **System** tab.
2. Click **Password**.
3. In the **Password** box, type the password you want to set, and then in the **Confirm password** box, type the same password again to confirm your choice.
4. Click **Apply** to save the password.

### Lock the control-panel menus

The product includes a password-protection feature that locks many menu items. For information about setting up password protections, see [Turn on password protection on page 103](#).

### Private receive

The private receive feature allows you to store faxes in memory, without printing them, until you are at the product and can provide a PIN to print the faxes. For more information, see [Turn on private receive feature on page 104](#).

# Use the convenience stapler (HP LaserJet M2727nfs mfp only)

## Staple documents

Activate the stapling mechanism by inserting media into the convenience stapler.

1. Insert up to 20 sheets of media (80 g/m<sup>2</sup> or 20 lb) into the slot in the stapler door. Insert fewer sheets to staple if the media weight is heavier than 80 g/m<sup>2</sup> or 20 lb.

△ **CAUTION:** Do not use the convenience stapler to staple plastic, cardboard, or wood. Damage to the convenience stapler can result from attempting to staple these materials.

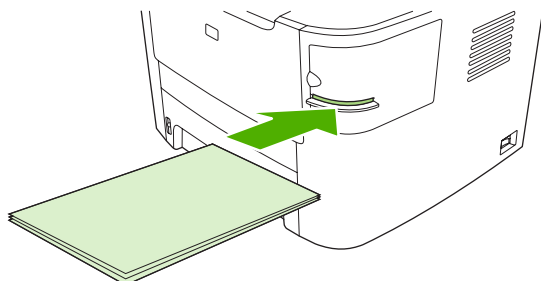

📄 **NOTE:** Exceeding the recommended capacity could result in jams or damage.

2. Wait for the stapler to staple the sheets. When it is inserted all the way into the stapler slot, the media should trigger the stapler mechanism.

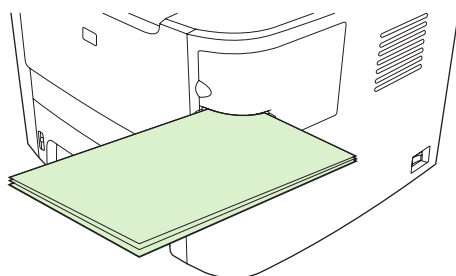

3. Remove the stapled media from the slot.

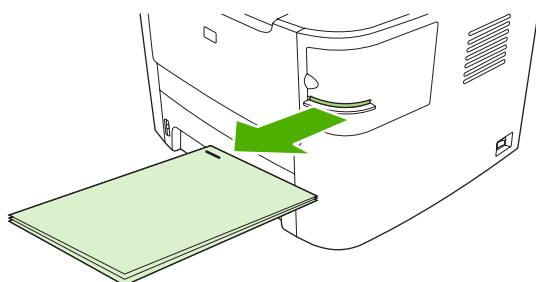

📄 **NOTE:** If you are unable to remove the media after stapling, carefully open the stapler door and then slide your document out.

## Load staples

Each staple cassette holds 1,500 unformed staples.

1. Open the stapler door.

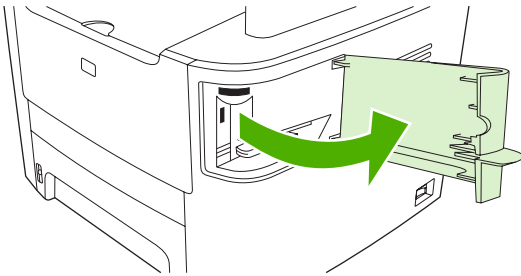

 **NOTE:** Opening the stapler door disables the stapler.

Instructions and replacement staples part numbers are listed on the stapler door.

2. If you are replacing a staple cassette (for example, if the staple cassette has run out of staples), remove the staple cassette from the product.

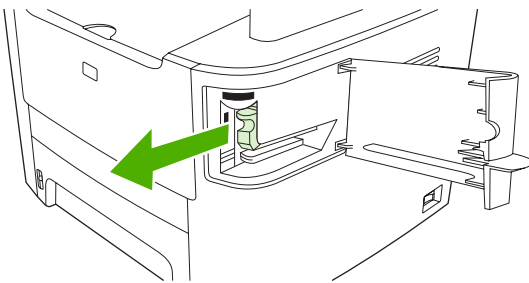

3. Insert a new staple cassette into the opening inside the staple door.

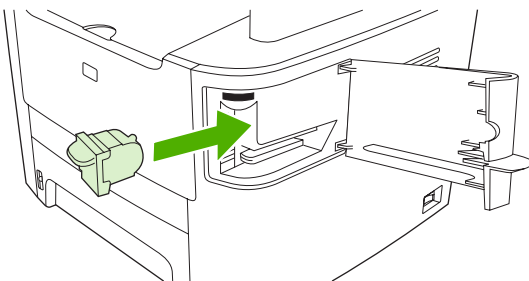

4. Close the stapler door.

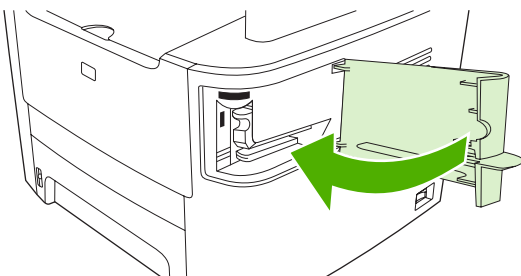



# Manage supplies

## Check and order supplies

You can check the supplies status by using the product control panel, printing a supplies status page, or viewing HP ToolboxFX. Hewlett-Packard recommends that you place an order for a replacement print cartridge when Low message for a print cartridge first appears. Use a new, authentic HP print cartridge to obtain the following types of supplies information:

- Amount of cartridge life remaining
- Estimated number of pages remaining
- Number of pages printed
- Other supplies information

 **NOTE:** If the product is connected to the network, you can set HP ToolboxFX to notify you by e-mail when a print cartridge is low. If the product is directly connected to a computer, you can set HP ToolboxFX to notify you when supplies are low.

---

## Check supplies status by using the control panel

Do one of the following:

- Check the product control panel, which indicates when a print cartridge is low or empty. The control panel also indicates when a non-HP print cartridge is first installed.
- Print a supplies status page, and then check the supplies levels on the page.

If the supplies levels are low, you can order supplies through a local HP dealer, by telephone, or online. See [Accessories and ordering information on page 213](#) for part numbers. Go to [www.hp.com/go/ljsupplies](http://www.hp.com/go/ljsupplies) to order online.

## Check supplies status by using HP ToolboxFX

You can configure HP ToolboxFX to notify you when the supplies are low. Choose to receive alerts by e-mail or as a pop-up message or taskbar icon.

## Store supplies

Follow these guidelines for storing print cartridges:

- Do not remove the print cartridge from its package until you are ready to use it.
- 
- △ **CAUTION:** To prevent damage, do not expose the print cartridge to light for more than a few minutes.
- 
- See [Environmental specifications on page 225](#) for operating and storage temperature ranges.
  - Store the supply in a horizontal position.
  - Store the supply in a dark, dry location away from heat and magnetic sources.

## HP policy on non-HP supplies

Hewlett-Packard Company cannot recommend the use of non-HP supplies, either new or remanufactured. Because they are not HP products, HP cannot influence their design or control their quality. Service or repairs required as a result of using a non-HP supply will *not* be covered under the warranty.

## HP fraud hotline

Call the HP fraud hotline if the product or HP ToolboxFX indicates that the print cartridge is not an HP print cartridge and you think that it is genuine. HP will help determine if the product is genuine and take steps to resolve the problem.

The print cartridge might not be a genuine HP one if you notice the following issues:

- You are experiencing a large number of problems with the print cartridge.
- The print cartridge does not look like it usually does (for example, the pull tab or the box is different).

*In the United States*, call toll-free: 1-877-219-3183.

*Outside the United States*, you can call collect. Dial the operator and ask to place a collect call to this telephone number: 1-770-263-4745. If you do not speak English, a representative at the HP fraud hotline who speaks your language will assist you. Or, if someone who speaks your language is not available, a language line interpreter will connect approximately one minute after the beginning of the call. The language line interpreter is a service that will translate between you and the representative for the HP fraud hotline.

## Recycle supplies

To install a new HP print cartridge, follow the instructions that are included in the box that contains the new supply, or see the getting started guide.

To recycle supplies, place the used supply in the box in which the new supply arrived. Use the enclosed return label to send the used supply to HP for recycling. For complete information, see the recycling guide that is included with each new HP supply item. See [HP LaserJet print supplies on page 229](#) for more information about HP's recycling program.

## Redistribute toner

If faded or light areas appear on the printed page, you might be able to temporarily improve print quality by redistributing the toner.

1. Remove the print cartridge from the printer.
2. To redistribute the toner, gently rock the print cartridge from front to back.

△ **CAUTION:** If toner gets on your clothing, wipe it off with a dry cloth and wash the clothing in cold water. *Hot water sets toner into the fabric.*

3. Reinsert the print cartridge into the printer, and close the print cartridge door. If the print is still light or unacceptable, install a new print cartridge.

## Replace supplies

### Print cartridge

1. Open the print-cartridge door.

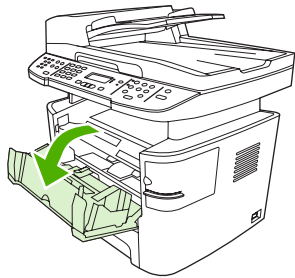

2. Grasp the handle on the print cartridge and then pull the cartridge straight out to remove it. See the recycling information inside the print cartridge box.

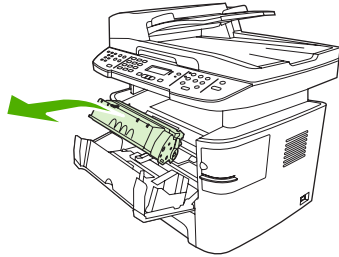

3. Remove the new print cartridge from its packaging, remove the orange cover from the print cartridge, and then pull the orange tab straight out to remove the sealing tape.

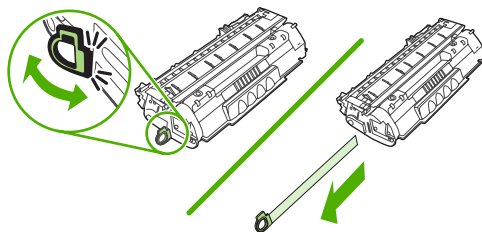

4. Insert the cartridge into the product until it is *firmly* in place.

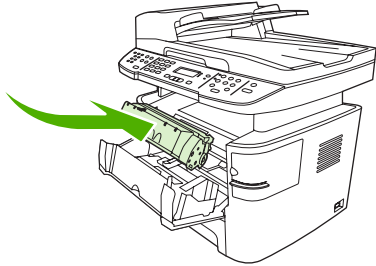

5. Close the print-cartridge door.

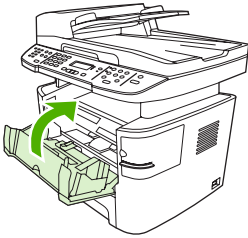

---

△ **CAUTION:** If toner gets on any clothing, wipe it off with a dry cloth and wash the clothing in cold water. *Hot water sets toner into the fabric.*

---

## Memory DIMMs

### Information

The product comes with 64 MB of RAM and can be upgraded to 320 MB via the DIMM slot, which is accessible from the left side of the product.

### Install a memory DIMM

---

△ **CAUTION:** Handling a DIMM without wearing a grounded, antistatic device might damage the DIMM. Touch any metal part of the product or other grounded metal before touching the DIMM.

---

1. Use the power switch to turn off the product, and then unplug all of the cables and cords connected to the product.

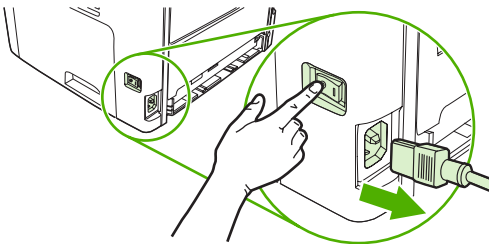

2. Open the DIMM door.

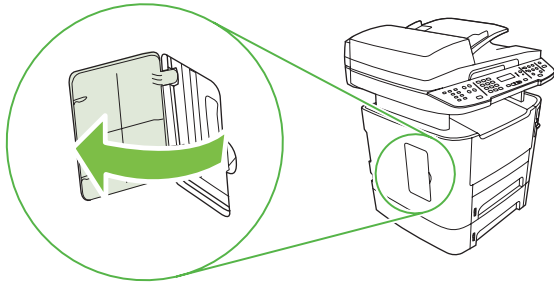

3. Remove the DIMM from the antistatic bag it came in, grasping the DIMM on the top edge.

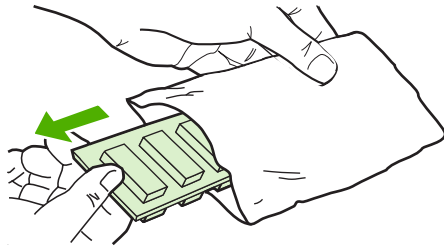

4. With the gold contacts facing upward, insert the DIMM in the DIMM seat and press the DIMM body in until the metal retaining pins click.

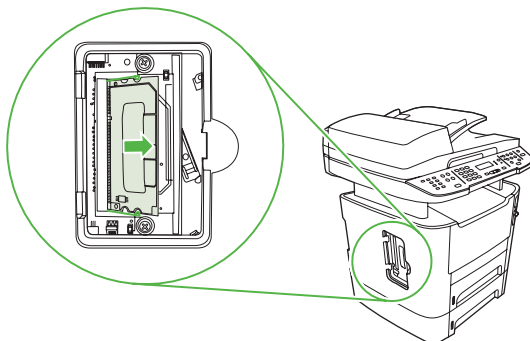
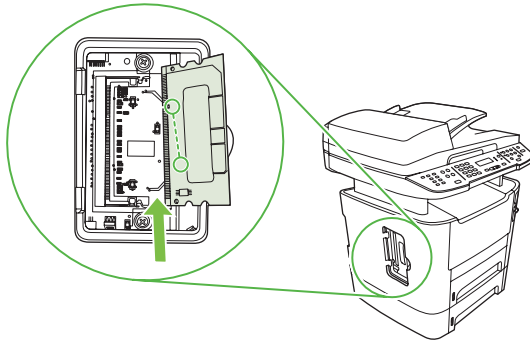

5. Close the DIMM door.

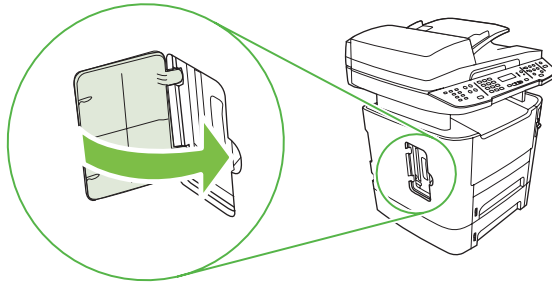

6. Reconnect all cables and cords, and then use the power switch to turn on the product.
7. Print a configuration page, and then verify that the Memory section shows the new memory amount. See [Information pages on page 142](#).

## Clean the product

### Clean the paper path

During the printing process, paper, toner, and dust particles can accumulate inside the product. Over time, this buildup can cause print-quality problems such as toner specks or smearing. This product has a cleaning mode that can correct and prevent these types of problems.

Specks

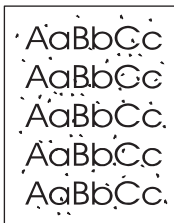

Smearing

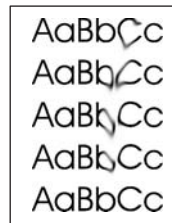

### Clean the paper path from HP ToolboxFX

Use HP ToolboxFX to clean the paper path. This is the recommended cleaning method. If you do not have access to HP ToolboxFX, use the method in [Clean the paper path from the product control panel on page 163](#).

1. Make sure that the product is turned on and in the Ready state, and that media is loaded in tray 1 or tray 2.
2. Open HP ToolboxFX, click the product, and then click the **System Settings** tab.
3. Click the **Service** tab, and then click **Start**.

A page feeds through the product slowly. Discard the page when the process is completed.

### Clean the paper path from the product control panel

If you do not have access to HP ToolboxFX, you can print and use a cleaning page from the product control panel.

1. Press **Setup**.
2. Use the arrow buttons to find the **Service** menu, and then press **OK**.
3. Use the arrow buttons to find **Cleaning mode**, and then press **OK**.
4. Load plain letter or A4 paper when you are prompted.
5. Press **OK** again to confirm and begin the cleaning process.

A page feeds through the product slowly. Discard the page when the process is completed.

### Clean the automatic document feeder (ADF) pickup roller assembly

If the ADF has trouble feeding documents, clean the ADF pickup roller assembly.

1. Turn off the product and unplug the power cord.

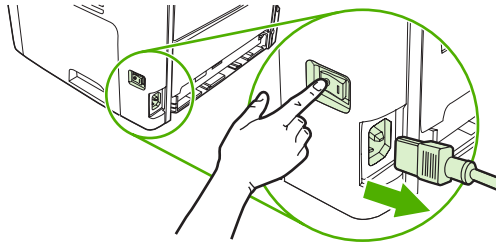

2. Open the ADF cover.

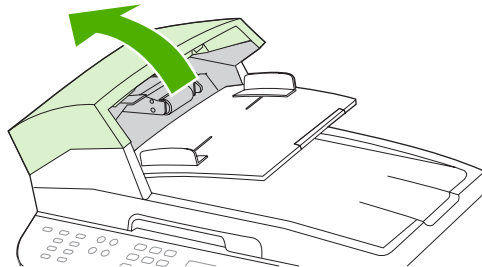

3. Rotate the assembly upward. Wipe it clean and rotate the rollers until the assembly is clean.

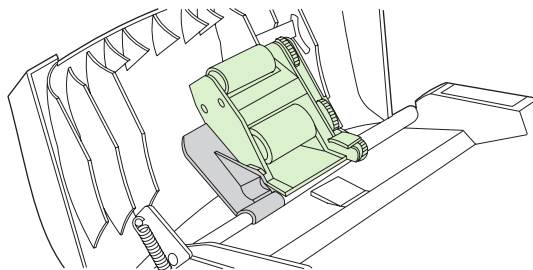

4. Lower the green lever assembly and close the ADF cover.

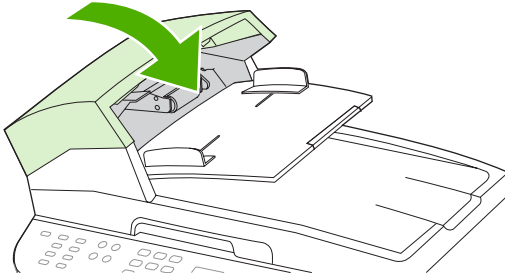

**NOTE:** If you are experiencing jams in the ADF, contact HP. See [www.hp.com/support/LJM2727](http://www.hp.com/support/LJM2727) or the support flyer that came in the product box.

5. Plug in the product, and then turn on the product.

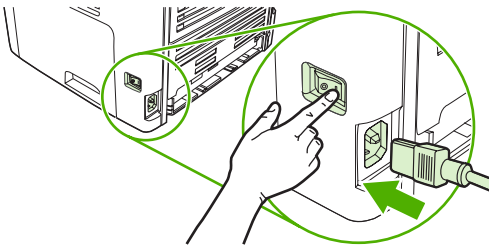

## Clean the lid backing

Minor debris can accumulate on the white document lid backing that is located underneath the product lid.

1. Turn off the product, unplug the power cord, and raise the lid.
2. Clean the white document lid backing by using a soft cloth or sponge that has been moistened with a mild soap and warm water. Wash the backing gently to loosen debris; do not scrub the backing.

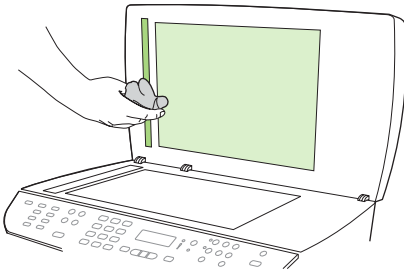

3. Also, clean the scanner strip next to the ADF scanner glass.
4. Dry the backing by using a chamois or soft cloth.

**CAUTION:** Do not use paper-based wipes because they might scratch the backing.

5. If this does not clean the backing well enough, repeat the previous steps and use isopropyl alcohol to dampen the cloth or sponge, and then wipe the backing thoroughly with a damp cloth to remove any residual alcohol.



## Clean the exterior

Use a soft, damp, lint-free cloth to wipe dust, smudges, and stains off of the exterior of the product.

## Firmware updates

Firmware updates and installation instructions for this product are available at [www.hp.com/support/LJM2727](http://www.hp.com/support/LJM2727). Click **Downloads and drivers**, click the operating system, and then select the firmware download for the product.

---

 **NOTE:** In certain areas of California, air pollution control regulations restrict the use of liquid Isopropyl Alcohol (IPA) as a cleaning agent. In those areas of California, please disregard the previous recommendations and use a dry, lint-free cloth. The cloth may be moistened with water if desired.

---



---

# 12 Problem solve

- [Problem-solving checklist](#)
- [Restore the factory-set defaults](#)
- [Control-panel messages](#)
- [Control-panel display problems](#)
- [Clear jams](#)
- [Solve image-quality problems](#)
- [Solve convenience stapler problems](#)
- [Solve connectivity problems](#)
- [Solve software problems](#)

# Problem-solving checklist

Follow these steps when trying to solve a problem with the product.

Step number	Verification step	Possible problems	Solutions
1	<b>Is the power on?</b>	No power due to failed power source, cable, switch, or fuse.	<ol style="list-style-type: none"> <li>1. Verify that the product is plugged in.</li> <li>2. Verify that the power cable is functional and that the power switch is on.</li> <li>3. Check the power source by plugging the product directly into the wall or into a different outlet.</li> </ol>
2	<b>Does Ready appear in the product control panel?</b>  The control panel should function without error messages.	Control panel shows an error.	See <a href="#">Control-panel messages on page 170</a> for a list of common messages that will help you correct the error.
3	<b>Do information pages print?</b>  Print a configuration page. See <a href="#">Information pages on page 142</a> .	<p>An error message appears on the control-panel display.</p> <hr/> <p>Paper jams when printing.</p>	<p>See <a href="#">Control-panel messages on page 170</a> for a list of common messages that will help you correct the error.</p> <hr/> <p>Make sure that media that meets HP specifications. See <a href="#">Paper and print media on page 45</a></p> <p>Clean the paper path. See <a href="#">Clean the paper path on page 162</a>.</p>
4	<b>Does the product copy?</b>  Place the configuration page into the ADF and make a copy. The report should feed smoothly through the ADF, and copies should print without print-quality problems. Make a copy from the flatbed as well.	<p>Poor copy quality from the ADF.</p> <hr/> <p>Paper jams when printing.</p> <hr/> <p>Poor copy quality from the flatbed.</p>	<p>If the print quality from the internal tests and the copy from the flatbed were acceptable, clean the ADF scanning strip. See <a href="#">Clean the scanner glass on page 88</a>.</p> <hr/> <p>Make sure that media that meets HP specifications. See <a href="#">Paper and print media on page 45</a></p> <p>Clean the paper path. See <a href="#">Clean the paper path on page 162</a>.</p> <hr/> <ol style="list-style-type: none"> <li>1. If the print quality from the internal tests and the copy from the ADF were acceptable, clean the flatbed glass. See <a href="#">Clean the scanner glass on page 88</a>.</li> <li>2. If, after performing the maintenance, the problem persists, see <a href="#">Copy problems on page 197</a>.</li> </ol>
5	<b>Does the product send a fax?</b>  Press <b>Start Fax</b> to verify that a dial tone exists (using a hand set, if necessary). Attempt to send a fax.	<p>The telephone line is not operational or the product is not plugged into the telephone line.</p> <hr/> <p>The telephone cord is faulty or is plugged into the wrong connector.</p>	<p>Verify that the product is plugged into a telephone line that you know works.</p> <hr/> <ol style="list-style-type: none"> <li>1. Try plugging the telephone cord into the other connector.</li> <li>2. Try a new telephone cord.</li> </ol>

Step number	Verification step	Possible problems	Solutions
6	<b>Does the product receive a fax?</b>	Too many telephone devices are plugged in, or telephone devices are not connected in the correct order.	Make sure that the HP LaserJet M2727 mfp is the only device on the telephone line and try again to receive the fax.
	Use another fax machine to send a fax to the product, if available.	The product fax settings are set incorrectly.	Review and reset the product fax settings. See <a href="#">Change fax settings on page 105</a>
7	<b>Does the product print from the computer?</b>	Software is not installed correctly or an error occurred during software installation.	Uninstall and then reinstall the product software. Verify that you are using the correct installation procedure and the correct port setting.
	Use a word-processing program to send a print job to the product.	The cable is not connected correctly.	Reconnect the cable.
		An incorrect driver is selected.	Select the proper driver.
		There is a port driver problem in Microsoft Windows.	Uninstall and then reinstall the product software. Verify that you are using the correct installation procedure and the correct port setting.
8	<b>Does the product scan to the computer?</b>	The cable is not connected correctly.	Reconnect the cable.
	Initiate a scan from the basic desktop software at your computer.	Software is not installed correctly or an error occurred during software installation.	Uninstall and then reinstall the product software. Verify that you are using the correct installation procedure and the correct port setting.
If the error persists, turn off the product and then turn on the product.			

## Restore the factory-set defaults

Restoring the factory-set defaults returns all of the settings to the factory defaults, and it also clears the fax header name, phone number, speed dials, and any stored faxes in the product memory.

△ **CAUTION:** This procedure also clears all fax numbers and names that are associated with one-touch keys and speed-dial codes, and deletes any pages that are stored in the memory. The procedure then automatically restarts the product.

1. On the product control panel, press **Setup**.
2. Use the arrows buttons to select **Service**, and then press **OK**.
3. Use the arrows buttons to select **Restore defaults**, and then press **OK**.

The product automatically restarts.

# Control-panel messages

The majority of the control-panel messages are intended to guide the user through typical operation. The control-panel messages indicate the status of the current operation, and include a page count on the second line of the display, if appropriate. When the product is receiving fax data, print data, or scanning commands, control-panel messages indicate this status. In addition, alert messages, warning messages, and critical error messages indicate situations that might require some action.

## Alert and warning messages

Alert and warning messages appear temporarily and might require the user to acknowledge the message by pressing **OK** to resume or by pressing **Cancel** to cancel the job. With certain warnings, the job might not complete or the print quality might be affected. If the alert or warning message is related to printing and the auto-continue feature is on, the product will attempt to resume the printing job after the warning has appeared for 10 seconds without acknowledgement.

## Alert and warning message tables

To solve fax issues, see [Solve fax problems on page 129](#).

**Table 12-1** Alert and warning messages

Control panel message	Description	Recommended action
<b>10.0000 Supply Memory Error</b>	A specific print cartridge has an e-label error.	Reinstall the print cartridge.  Turn off and then turn on the product.  If the problem is not solved, replace the cartridge.
<b>10.1000 Supply Memory Error</b>	A specific print cartridge has a missing e-label.	Reinstall the print cartridge.  Turn off and then turn on the product.  If the problem is not solved, replace the cartridge.
<b>ADF door is open</b>	The ADF lid is open or a sensor is malfunctioning.	Make sure that the ADF lid is closed.  Remove the ADF and reinstall it.  If the message persists, turn off the power by using the power switch, wait at least 30 seconds, and then turn on the power and wait for the product to initialize.  If the error persists, contact HP. See <a href="http://www.hp.com/support/LJM2727">www.hp.com/support/LJM2727</a> or the support flyer that came in the product box.
<b>Canceled copy. Clear document</b>	The <b>Cancel</b> button was pressed to cancel the current job while pages were feeding from the ADF. The cancel process does not automatically clear the ADF.	Remove the jammed item. See <a href="#">Clear jams from the ADF on page 177</a> . Then, clear the items in the ADF tray and start over.
<b>Canceled scan. Clear document</b>	The <b>Cancel</b> button was pressed to cancel the current job while pages were feeding from the ADF. The cancel process does not automatically clear the ADF.	Remove the jammed item. See <a href="#">Clear jams from the ADF on page 177</a> . Then, clear the items in the ADF tray and start over.

**Table 12-1 Alert and warning messages (continued)**

Control panel message	Description	Recommended action
<b>Canceled send. Clear document</b>	The <b>Cancel</b> button was pressed to cancel the current job while pages were feeding from the ADF tray. The cancel process does not automatically clear the ADF.	Remove the jammed item. See <a href="#">Clear jams from the ADF on page 177</a> . Then, clear the items in the ADF tray and start over.
<b>Comm. error [Receiver CSID]</b>	A fax communication error occurred between the product and the receiver.	<p>Allow the product to retry sending the fax. Unplug the product telephone cord from the wall, plug in a telephone, and try making a call. Plug the product phone cord into a jack for another phone line.</p> <p>Try a different phone cord.</p> <p>If the error persists, contact HP. See <a href="http://www.hp.com/support/LJM2727">www.hp.com/support/LJM2727</a> or the support flyer that came in the product box.</p>
<b>Comm. error [Sender CSID]</b>	A fax communication error occurred between the product and the sender.	<p>Allow the product to retry sending the fax. Unplug the product telephone cord from the wall, plug in a telephone, and try making a call. Plug the product phone cord into a jack for another phone line.</p> <p>Try a different phone cord.</p> <p>If the error persists, contact HP. See <a href="http://www.hp.com/support/LJM2727">www.hp.com/support/LJM2727</a> or the support flyer that came in the product box.</p>
<b>Device error, press OK</b>	Generic engine error.	This is a warning message only. Job output might be affected.
<b>Device is busy. Try again later</b>	The product is currently in use.	Wait for the product to finish the current job.
<b>Doc feeder jam Clear, Reload</b>	A piece of media is jammed in the ADF tray.	<p>Open the document release door, clear the jam, close the document release door, and reload the paper into the ADF tray.</p> <p>If the error persists, contact HP. See <a href="http://www.hp.com/support/LJM2727">www.hp.com/support/LJM2727</a> or the support flyer that came in the product box.</p>
<b>Doc feeder jam, DATE/TIME</b>	ADF has not been cleared since previous jam.	Clear the jam.
<b>Document feeder misspick. Reload</b>	Media in the ADF tray was not picked up.	<p>Remove the media from the ADF tray, and then reload it.</p> <p>Clean the ADF pickup roller. See <a href="#">Clean the automatic document feeder (ADF) pickup roller assembly on page 163</a>.</p> <p>If the error persists, contact HP. See <a href="http://www.hp.com/support/LJM2727">www.hp.com/support/LJM2727</a> or the support flyer that came in the product box.</p>
<b>Door open</b>	The print-cartridge door is open.	Close the print-cartridge door.
<b>Engine comm. error</b>	The product experienced a print engine communication error.	This is a warning message only. Job output might be affected.
<b>Engine error, press OK</b>	The product experienced a print engine error.	This is a warning message only. Job output might be affected.

**Table 12-1 Alert and warning messages (continued)**

Control panel message	Description	Recommended action
<b>Fit to Page on flatbed only</b>	The copy reduce/enlarge feature (called "Fit to Page") applies only to copies made from the flatbed scanner.	Use the flatbed or select another reduction/enlargement setting.
<b>Install black cartridge</b>	No cartridge installed with door closed.	Install print cartridge.
<b>Invalid driver Press OK</b>	You are using the incorrect printer driver.	Select the printer driver that is appropriate for your product.
<b>Invalid entry</b>	Invalid data or response.	Correct the entry.
<b>Jam in (area), Open door and clear jam</b>	Paper jam in one of the following areas: drum area, fuser area, duplex feeding area, duplex receiving area, and duplex pickup area.	Clear the jam from the area indicated on the product control panel, and then follow the control panel instructions. See <a href="#">Clear jams on page 176</a> .
<b>Jam in Tray #, Clear jam and then press OK</b>	The product has detected a jam in one of the following areas: tray 1, tray 2, or tray 3.	Clear the jam from the area indicated on the product control panel, and then follow the control panel instructions. See <a href="#">Clear jams on page 176</a> .
<b>Load paper</b>	Out of paper in all available trays.	Load paper in trays.
<b>Load Tray # &lt;TYPE&gt; &lt;SIZE&gt;, Press OK to use available media</b>	Device is processing job, but a matching tray is empty.	Press <b>OK</b> to use existing available media.
<b>Load tray #, Press OK</b>	Manual duplex mode. "#" is the tray number where the first half of the job printed.	Load paper in the correct tray.
<b>Load Tray 1 &lt;TYPE&gt; &lt;SIZE&gt;, Press OK to use available media</b>	Device is processing job, but no trays match.	Press <b>OK</b> to use existing tray settings.
<b>Load Tray 1, &lt;PLAIN&gt; &lt;SIZE&gt; / Cleaning mode, OK to start</b>	Cleaning mode paper prompt.	Press <b>OK</b> to begin the cleaning procedures.
<b>Manual feed &lt;SIZE&gt; &lt;TYPE&gt;, Press OK to use available media</b>	Print Manual Feed mode.	Load paper into tray 1.
<b>Mem. low 1 copy. Press OK</b>	The product completed making one copy. The remaining copies have been canceled because of low memory.	Press <b>Cancel</b> to clear the error. Break the job into smaller jobs that contain fewer pages.
<b>Memory is low Try again later</b>	The product does not have enough memory to start a new job.	Wait until the current job is finished before starting a new job.
<b>Memory is low. Press OK</b>	The product memory has been almost completely filled.	Allow the product to finish the job, or press <b>Setup</b> to cancel the job.
<b>Memory low Only 1 copy made</b>	The product does not have enough memory to complete the collated copy job.	Break the job into smaller jobs that contain fewer pages.
<b>Misprint, Press OK</b>	Feed delay misprint.	Reload paper.
<b>No paper pickup, Press OK</b>	The product has failed to pick up a piece of media.	Verify that the media was inserted far enough into the input tray. In tray 2, verify that the paper-length guide is in the correct position for the media size that you are using.  Reload the media in the input tray and press <b>Setup</b> to continue the job.  If the error persists, contact HP. See <a href="http://www.hp.com/support/LJM2727">www.hp.com/support/LJM2727</a> or the support flyer that came in the product box.



**Table 12-1 Alert and warning messages (continued)**

Control panel message	Description	Recommended action
<b>Non-HP supply Installed</b>	A new supply has been installed that is not made by HP. This message is appears for several seconds, and then the product returns to the Ready state.	If you believe you purchased an HP supply, please call the HP fraud hotline at 1-877-219-3183. Service or repairs that are required as a result of using non-HP supplies is not covered under HP warranty.
<b>Order black Cartridge</b>	Print cartridge is low.	Order a new print cartridge.
<b>Page too complex, press OK</b>	The product could not print the current page because of its complexity.	Press <b>Setup</b> to clear the message. Allow the product to finish the job, or press <b>Cancel</b> to cancel the job.
<b>Paper path jam. Open door/Remove tray 2, Push green lever</b>	Paper jam in the duplexer	Clear the jam from the area, and then follow the control-panel instructions.
<b>Scanner reserved for PC scan</b>	A computer is using the product to create a scan.	Wait until the computer scan has finished, or cancel the scan from the computer software, or press <b>Cancel</b> .
<b>Scanning error Cannot connect</b>	The product cannot transmit scan information to a computer.	Verify that the connection cable is not loose or damaged. Replace the cable if necessary, and try the scan again.
<b>Settings cleared, DATE/TIME</b>	The product has cleared job settings.	Re-enter any appropriate job settings.
<b>Used black cartridge in use</b> alternates with <b>to accept, press OK</b>	A used printer cartridge has been installed or moved.	Press <b>OK</b> to return to the Ready state.

## Critical error messages

Critical error messages can indicate some kind of failure. Turning off and then turning on the power might fix the problem. If a critical error persists, the product might require service.

### Critical error message-tables

**Table 12-2 Critical error messages**

Control panel message	Description	Recommended action
<b>49 Error, Turn off then on</b>	The product has experienced an internal embedded software error.	<p>Turn off the power by using the power switch, wait at least 30 seconds, and then turn on the power and wait for the product to initialize.</p> <p>If the error persists, contact HP. See <a href="http://www.hp.com/support/LJM2727">www.hp.com/support/LJM2727</a> or the support flyer that came in the product box.</p>
<b>50.x Fuser Error</b>	The product has experienced an internal hardware error.	<ol style="list-style-type: none"><li>1. Turn off the power by using the power switch, and then wait at least 30 seconds.</li><li>2. If a surge protector is being used, remove it. Plug the product directly into the wall socket.</li><li>3. Turn on the power and wait for the product to initialize.</li></ol> <p>If the error persists, contact HP. See <a href="http://www.hp.com/support/LJM2727">www.hp.com/support/LJM2727</a> or the support flyer that came in the product box.</p>
<b>52 Scanner Error</b>	The product has experienced an internal hardware error.	<p>Turn off the power by using the power switch, wait at least 30 seconds, and then turn on the power and wait for the product to initialize.</p> <p>If a surge protector is being used, remove it. Plug the product directly into the wall socket. Use the power switch to turn the product on.</p> <p>If the error persists, contact HP. See <a href="http://www.hp.com/support/LJM2727">www.hp.com/support/LJM2727</a> or the support flyer that came in the product box.</p>
<b>55.4 Error, Turn off then on</b>	The product has experienced an engine communication timeout error.	<p>Turn off the power by using the power switch, wait at least 30 seconds, and then turn on the power and wait for the product to initialize.</p> <p>If a surge protector is being used, remove it. Plug the product directly into the wall socket. Use the power switch to turn the product on.</p> <p>If the error persists, contact HP. See <a href="http://www.hp.com/support/LJM2727">www.hp.com/support/LJM2727</a> or the support flyer that came in the product box.</p>
<b>57 Fan Error, Turn off then on</b>	The product has experienced a problem with its internal fan.	<p>Turn off the power by using the power switch, wait at least 30 seconds, and then turn on the power and wait for the product to initialize.</p> <p>If the error persists, contact HP. See <a href="http://www.hp.com/support/LJM2727">www.hp.com/support/LJM2727</a> or the support flyer that came in the product box.</p>

**Table 12-2 Critical error messages (continued)**

Control panel message	Description	Recommended action
<b>79 Error Turn off then on</b>	The product has experienced an internal firmware error.	<p>Turn off the power by using the power switch, wait at least 30 seconds, and then turn on the power and wait for the product to initialize.</p> <p>If you have recently installed a memory DIMM in the product, turn off the product, remove the memory DIMM, reinstall the DIMM to verify that it is seated properly, and then turn on the product.</p> <p>If a surge protector is being used, remove it. Plug the product directly into the wall socket. Use the power switch to turn the product on.</p> <p>If the error persists, contact HP. See <a href="http://www.hp.com/support/LJM2727">www.hp.com/support/LJM2727</a> or the support flyer that came in the product box.</p>
<b>79 Service error, Turn off then on</b>	The product has experienced a problem with the DIMM slot.	<p>Turn off the power by using the power switch, wait at least 30 seconds, and then turn on the power and wait for the product to initialize.</p> <p>If you have recently installed a memory DIMM in the product, turn off the product, remove the memory DIMM, reinstall the DIMM to verify that it is seated properly, and then turn on the product.</p> <p>If a surge protector is being used, remove it. Plug the product directly into the wall socket. Use the power switch to turn the product on.</p> <p>If the error persists, contact HP. See <a href="http://www.hp.com/support/LJM2727">www.hp.com/support/LJM2727</a> or the support flyer that came in the product box.</p>
<b>Scanner error #, Turn off then on</b>	The product has experienced an error in the scanner sub-assembly area.	<p>Turn off the power by using the power switch, wait at least 30 seconds, and then turn on the power and wait for the product to initialize.</p> <p>If a surge protector is being used, remove it. Plug the product directly into the wall socket. Use the power switch to turn the product on.</p> <p>If the error persists, contact HP. See <a href="http://www.hp.com/support/LJM2727">www.hp.com/support/LJM2727</a> or the support flyer that came in the product box.</p>

## Control-panel display problems

△ **CAUTION:** Static electricity can cause unexpected black lines or dots to appear on the product control-panel display. Do not touch the product control-panel display if there is a chance that you have collected a static electric charge (for example, by walking on carpet in a low-humidity environment).

Unexpected lines or dots might appear on the product control-panel display, or the display might become blank if the product is exposed to an electric or magnetic field. To resolve this problem, perform the following procedure:

1. Turn the product off.
2. Remove the product from the electric or magnetic field.
3. Turn the product on again.

## Clear jams

### Causes of jams

Occasionally, paper or other print media can become jammed during a print job. Some causes include the following events:

- The input trays are loaded improperly or overfilled, or the media guides are not set properly.
- Media is added to or removed from an input tray during a print job or an input tray is removed from the product during a print job.
- The cartridge door is opened during a print job.
- Too many sheets have accumulated in an output area, or sheets are blocking an output area.
- The print media that is being used does not meet HP specifications. See [Paper and print media on page 45](#).
- The media is damaged or has foreign objects attached to it, such as staples or paper clips.
- The environment in which the print media was stored is too humid or too dry. See [Paper and print media on page 45](#).

## Where to look for jams

Jams can occur in these locations:

- In the automatic document feeder (ADF)
- In input areas
- In the automatic duplexer
- In output areas
- Inside the product

Find and remove the jam by using the instructions on the following pages. If the location of the jam is not obvious, first look inside the product.

Loose toner might remain in the product after a jam. This problem typically resolves itself after a few sheets have been printed.

## Clear jams from the ADF

Occasionally, media becomes jammed during a fax, copy, or scan job.

You are notified of a media jam by the **Doc feeder jam Clear, Reload** message that appears on the product control-panel display.

- The ADF input tray is loaded incorrectly or is too full. See [Load paper and print media on page 49](#) for more information.
  - The media does not meet HP specifications, such as those for size or type. See [Paper and print media on page 45](#) for more information.
1. Open the ADF cover.

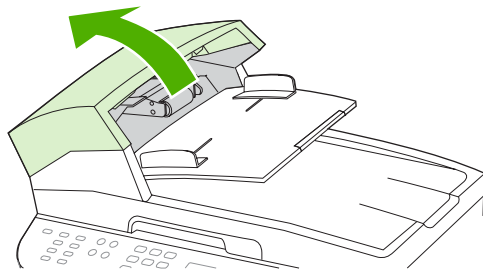

---

 **NOTE:** Verify that any shipping tape inside the ADF has been removed.

---

2. Remove the jam cleanout part. Using both hands, lift up on the two handles until the part unsnaps. Rotate and lift out the cleanout part and set it aside.

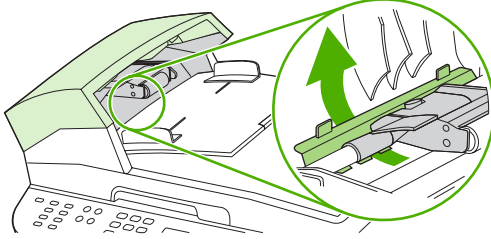

3. Lifting the green lever, rotate the pick mechanism until it stays open.

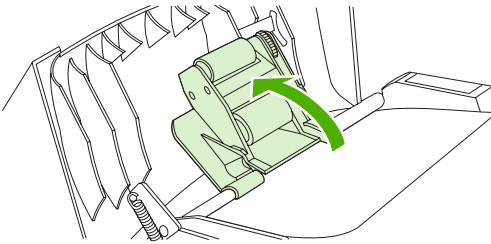

4. Gently try to remove the page without tearing it. If you feel resistance, go to the next step.

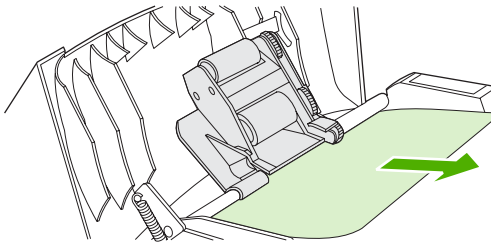

5. Open the ADF lid and gently loosen the media by using both hands.

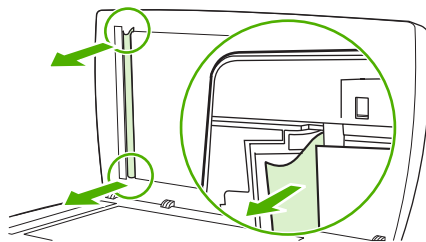

6. When the media is free, gently pull it out in the direction shown.

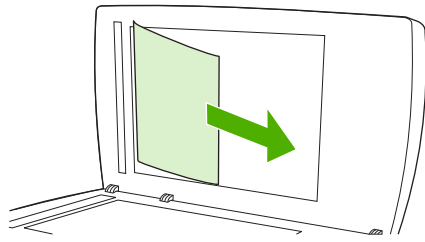

7. Close the lid to the flatbed scanner.

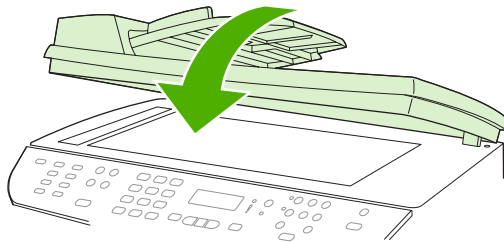

8. Lower the green lever.

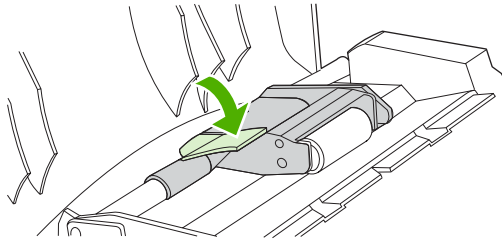

9. Reinstall the cleanout part by inserting it as shown. Push down on the two tabs until the part snaps into place. Install the cleanout part correctly, because future jamming might occur if the cleanout part is not replaced correctly.

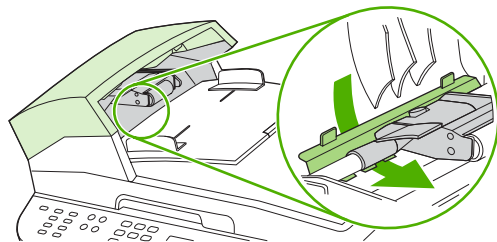

10. Close the ADF lid.

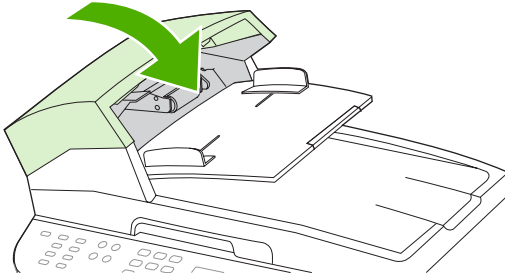

## Clear jams from the input-tray areas

△ **CAUTION:** Do not use sharp objects, such as tweezers or needle-nose pliers, to remove jams. Damage caused by sharp objects will not be covered by the warranty.

When removing jammed media, pull the jammed media straight away from the product. Pulling jammed media out of the product at an angle can damage the product.

📝 **NOTE:** Depending on where the jam is located, some of the following steps might not be necessary.

1. Open the rear output door.

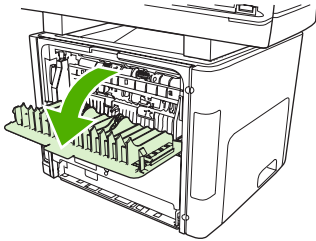

2. Rotate the green pressure release levers downward.

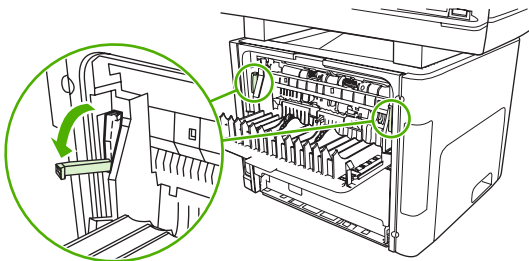

3. Open the print-cartridge door.

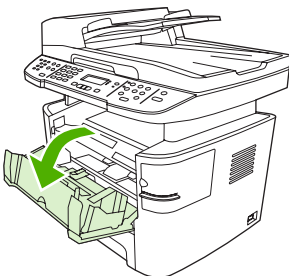



4. With both hands, grasp the side of the media that is most visible (this includes the middle), and carefully pull it free from the product.

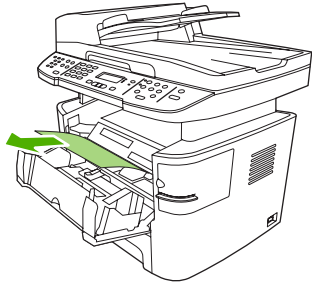

5. Close the print-cartridge door.

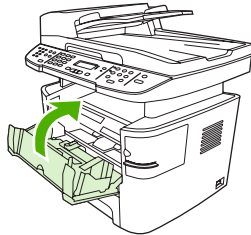

6. Open tray 2 and tray 3.

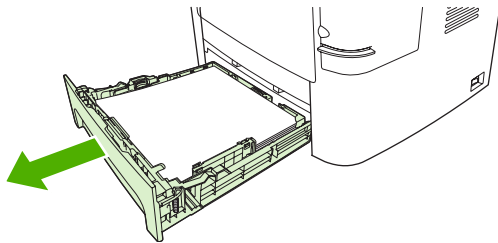

7. With both hands, grasp the side of the media that is most visible (this includes the middle), and carefully pull it free from the product.

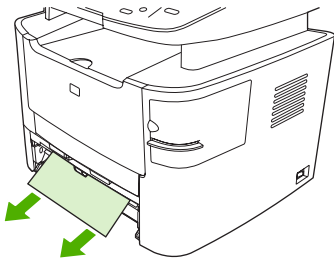

8. If no media is visible, open the print-cartridge door, remove the print cartridge, and rotate the upper media guide. Carefully pull the media up and out of the product.

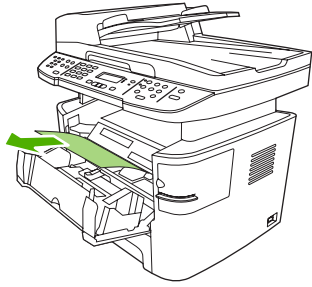

9. Close tray 2 and optional tray 3.
10. Close the rear output door.

## Clear jams from the duplexer

- △ **CAUTION:** Do not use sharp objects, such as tweezers or needle-nose pliers, to remove jams. Damage caused by sharp objects will not be covered by the warranty.

When removing jammed media, pull the jammed media straight away from the product. Pulling jammed media out of the product at an angle can damage the product.

- 📝 **NOTE:** Depending on where the jam is located, some of the following steps might not be necessary.

1. Open the rear output door.

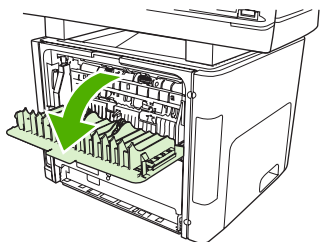

2. Rotate the green pressure release levers downward.

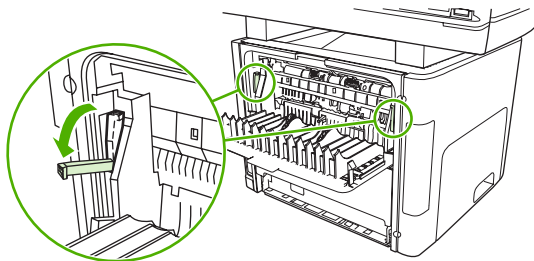

3. Remove tray 2.

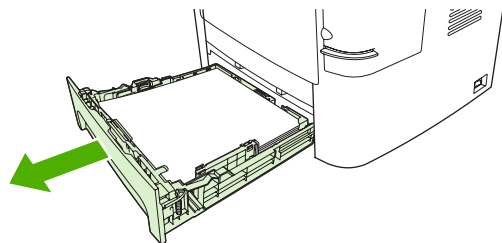

4. Push down on the green lever on the automatic two-sided path door on the front of the product.

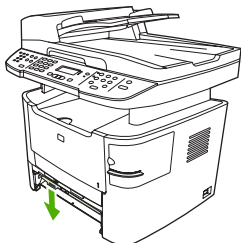

5. With both hands, grasp the side of the media that is most visible (this includes the middle), and carefully pull it free from the product.

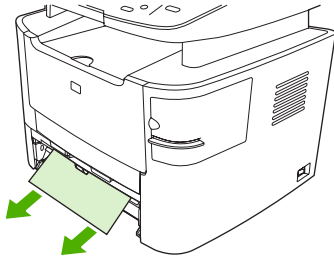

 **NOTE:** If you cannot grasp the media with your hands, perform the procedure in [Clear jams from the print-cartridge area on page 187](#).

6. Close the automatic two-sided path door.

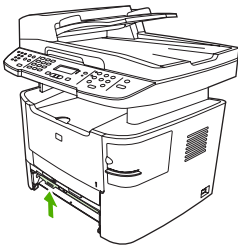

7. Reinsert tray 2.

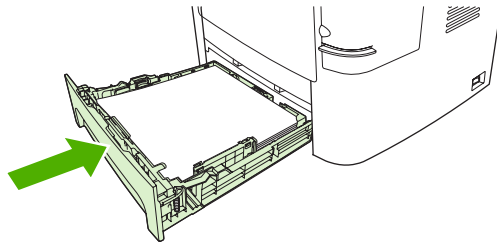

8. Close the rear output bin, and then open the automatic two-sided path door on the back of the product.

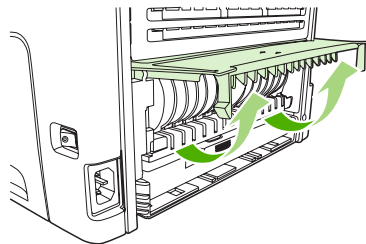

9. With both hands, grasp the side of the media that is most visible (this includes the middle), and carefully pull it free from the product.

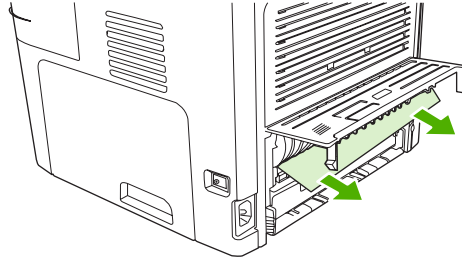

10. Close the automatic two-sided path door.

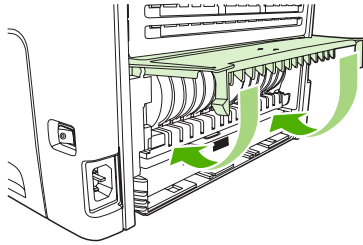

## Clear jams from the output-bin areas

### Top (face-down) output bin

- △ **CAUTION:** Do not use sharp objects, such as tweezers or needle-nose pliers, to remove jams. Damage caused by sharp objects will not be covered by the warranty.

With both hands, grasp the side of the media that is most visible (this includes the middle), and carefully pull it free from the product.

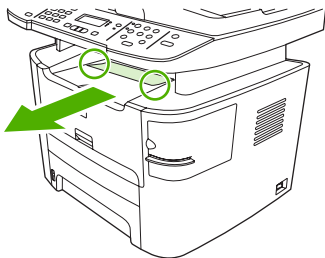

## Rear (face-up) output bin

△ **CAUTION:** Do not use sharp objects, such as tweezers or needle-nose pliers, to remove jams. Damage caused by sharp objects will not be covered by the warranty.

1. Open the straight-through output door.

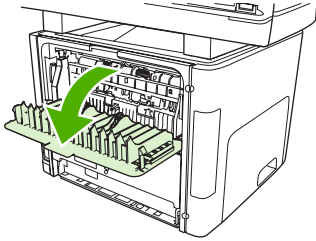

2. Pull down the green pressure-release levers.

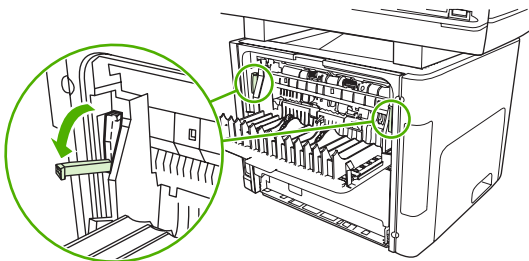

3. With both hands, grasp the side of the media that is most visible (this includes the middle), and carefully pull it free from the printer.

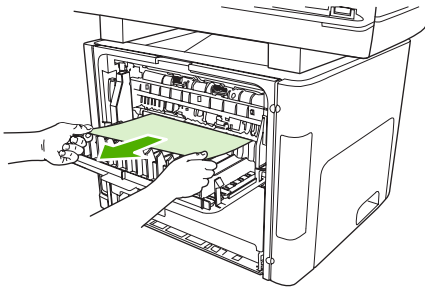

📄 **NOTE:** If you cannot grasp the media with your hands, perform the procedure in [Clear jams from the print-cartridge area on page 187](#).

4. Close the straight-through output door.

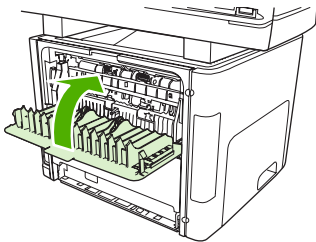

## Clear jams from the print-cartridge area

- △ **CAUTION:** Do not use sharp objects, such as tweezers or needle-nose pliers, to remove jams. Damage caused by sharp objects will not be covered by the warranty.

When removing jammed media, pull the jammed media straight away from the product. Pulling jammed media out of the product at an angle can damage the product.

1. Open the print-cartridge door, and remove the print cartridge.

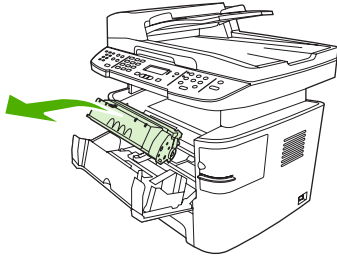

- △ **CAUTION:** To prevent damage to the print cartridge, minimize its exposure to direct light.

2. On the product, open the rear output door, and then rotate the green pressure-release levers downward.

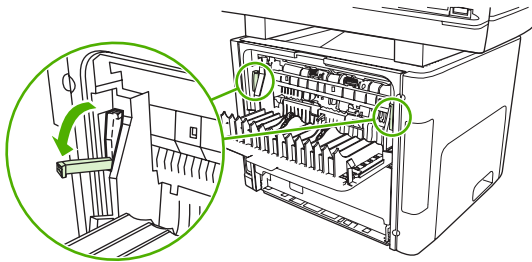

3. With both hands, grasp the side of the media that is most visible (this includes the middle), and carefully pull it free from the product.

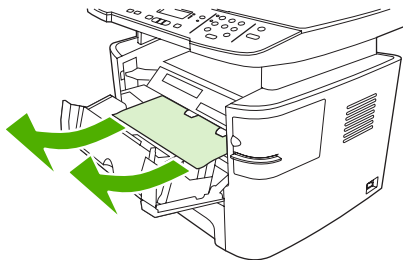

4. Replace the print cartridge and close the print-cartridge door.

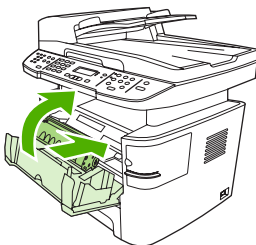

5. Close the rear output door.

## Clear jams from the convenience stapler (HP LaserJet M2727nfs mfp only)

To reduce the risk of staple jams, make sure that you staple 20 or fewer pages of media (80 g/m<sup>2</sup> or 20 lb) at a time.

1. Turn off the HP LaserJet M2727nfs mfp, and then open the stapler door.

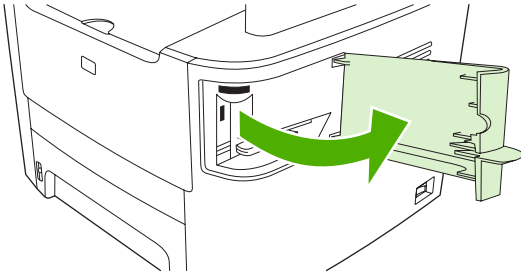

 **NOTE:** Opening the stapler door disables the stapler.

2. Remove the staple cassette from the product.

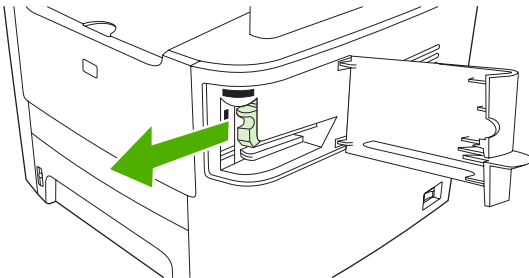

3. Clear any loose staples from the stapler and from the staple cassette.

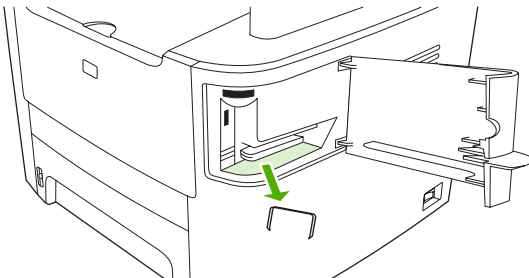

4. Replace the staple cassette.

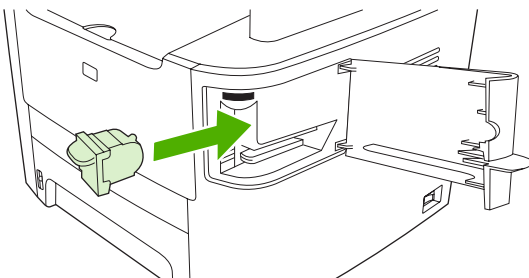



5. Close the stapler door, and then turn on the product.

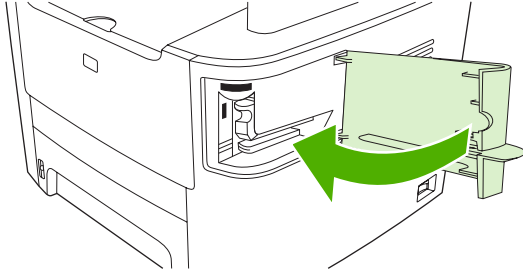

6. Insert media to test the convenience stapler. Repeat steps 1 through 6 if necessary.

## Avoid repeated jams

- Verify that the input tray is not overfilled. The input tray capacity varies depending on the type of print media that you are using.
- Verify that the media guides are properly adjusted.
- Check that the input tray is securely in place.
- Do not add print media into the input tray while the product is printing.
- Use only HP-recommended media types and sizes. See [Paper and print media on page 45](#) for more information about print media types.
- Do not fan media prior to loading it in a tray. To loosen the ream, hold it firmly in both hands and twist the media by rotating your hands in the opposite direction.
- Do not let print media stack up in the output bin. The print media type and the amount of toner used affect the output bin capacity.
- Check the power connection. Make sure that the power cord is firmly connected to both the product and the power supply box. Plug the power cord into a grounded power outlet.

# Solve image-quality problems

## Print problems

### Print quality problems



Occasionally, you might encounter problems with print quality. The information in the following sections helps you identify and resolve these issues.

 **NOTE:** If you are having copy problems, see [Copy problems on page 197](#).

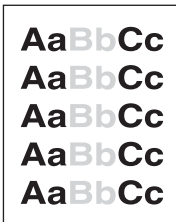
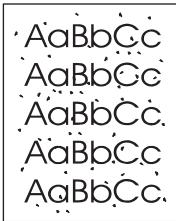
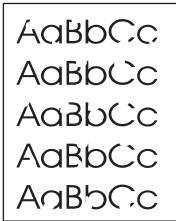

### General print-quality issues

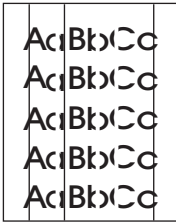

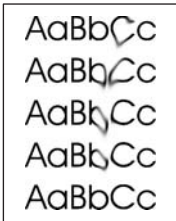
The following examples depict letter-size paper that has passed through the product short-edge-first. These examples illustrate problems that would affect all of the pages that you print. The topics that follow list the typical cause and solution for each of these examples.

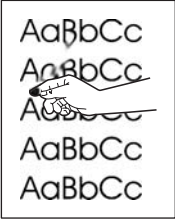
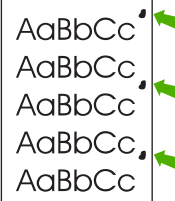
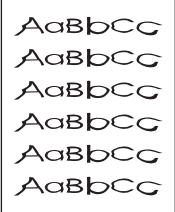
Problem	Cause	Solution
Print is light or faded.	The media might not meet HP specifications.	Use media that meets HP specifications. See <a href="#">Paper and print media on page 45</a> .
	The print cartridge might be defective. If you use a non-HP print cartridge, no messages appear on the product control panel or in HP ToolboxFX.	Replace the print cartridge. See <a href="#">Print cartridge on page 159</a> .  If the print cartridge is not low or empty, inspect the toner roller to see if the roller is damaged. If it is, replace the print cartridge.
	If the whole page is light, the print density adjustment is too light or EconoMode might be turned on.	Adjust the print density, and disable EconoMode in the product Properties.
Toner specks appear.	The media might not meet HP specifications.	Use media that meets HP specifications. See <a href="#">Paper and print media on page 45</a> .
	The paper path might need cleaning.	Clean the paper path. See <a href="#">Clean the paper path on page 162</a> , or see the HP ToolboxFX online Help.
Dropouts appear.	A single sheet of print media might be defective.	Try reprinting the job.
	The moisture content of the paper is uneven or the paper has moist spots on its surface.	Try different paper, such as high-quality paper that is intended for laser printers. See <a href="#">Paper and print media on page 45</a> .
	The paper lot is flawed. The manufacturing processes can cause some areas to reject toner.	
	The print cartridge might be defective.	Replace the print cartridge. See <a href="#">Print cartridge on page 159</a> .  If the error persists, contact HP. See <a href="http://www.hp.com/support/LJM2727">www.hp.com/support/LJM2727</a> or the support flyer that came in the product box.

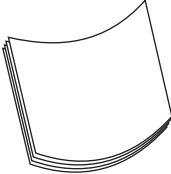
Problem	Cause	Solution
<p>Vertical streaks or bands appear on the page.</p> 	<p>The print cartridge might be defective. If you are using a non-HP print cartridge, no messages appear on the product control panel or in the HP ToolboxFX.</p>	<p>Replace the print cartridge. See <a href="#">Print cartridge on page 159</a>.</p>
<p>The amount of background toner shading becomes unacceptable.</p> 	<p>The media might not meet HP specifications.</p>	<p>Use a different paper with a lighter basis weight. See <a href="#">Paper and print media on page 45</a>.</p>
	<p>The single-sheet priority input tray might be installed incorrectly.</p>	<p>Make sure that the single-sheet priority input tray is in place.</p>
	<p>The print-density setting is too high.</p>	<p>Decrease the print-density setting through HP ToolboxFX or the embedded Web server. This decreases the amount of background shading.</p>
	<p>Very dry (low humidity) conditions can increase the amount of background shading.</p>	<p>Check the product environment.</p>
	<p>The print cartridge might be defective. If you are using a non-HP print cartridge, no messages appear on the product control panel or in the HP ToolboxFX.</p>	<p>Replace the print cartridge. See <a href="#">Print cartridge on page 159</a>.</p>
<p>Toner smears appear on the media.</p> 	<p>The media might not meet HP specifications.</p>	<p>Use media that meets HP specifications. See <a href="#">Paper and print media on page 45</a>.</p>
	<p>If toner smears appear on the leading edge of the paper, the media guides are dirty, or debris has accumulated in the print path.</p>	<p>Clean the media guides and the paper path. See <a href="#">Clean the paper path on page 162</a>.</p>
	<p>The print cartridge might be defective. If you are using a non-HP print cartridge, no messages appear on the product control panel or in the HP ToolboxFX.</p>	<p>Replace the print cartridge. See <a href="#">Print cartridge on page 159</a>.</p>
	<p>The fuser temperature might be too low.</p>	<p>In the printer driver, make sure the appropriate media type is selected.</p> <p>Use the archive print feature to improve toner fusing. See <a href="#">Archive print on page 65</a>.</p>

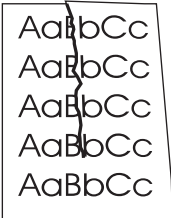
Problem	Cause	Solution
<p>The toner smears easily when touched.</p> 	<p>The product is not set to print on the type of media on which you want to print.</p>	<p>In the printer driver, select the <b>Paper/Quality</b> tab and set <b>Paper Type</b> to match the type of media on which you are printing. Print speed might be slower if you are using heavy paper.</p>
	<p>The media might not meet HP specifications.</p>	<p>Use media that meets HP specifications. See <a href="#">Paper and print media on page 45</a>.</p>
	<p>The paper path might need cleaning.</p>	<p>Clean the product. See <a href="#">Clean the paper path on page 162</a>.</p>
	<p>The power source might be defective.</p>	<p>Plug the product directly into an AC outlet instead of into a power strip.</p>
	<p>The fuser temperature might be too low.</p>	<p>Use the archive print feature to improve toner fusing. See <a href="#">Archive print on page 65</a>.</p>
<p>Marks repeatedly appear at even intervals on the page.</p> 	<p>The product is not set to print on the type of media on which you want to print.</p>	<p>In the printer driver, make sure that the appropriate media type is selected. Print speed might be slower if you are using heavy paper.</p>
	<p>Internal parts might have toner on them.</p>	<p>The problem typically corrects itself after a few more pages.</p>
	<p>The paper path might need cleaning.</p>	<p>Clean the product. See <a href="#">Clean the paper path on page 162</a>.</p>
	<p>The print cartridge might be damaged.</p>	<p>If a repetitive mark occurs at the same spot on the page, install a new HP print cartridge. See <a href="#">Print cartridge on page 159</a>.</p>
<p>The printed page contains misformed characters.</p> 	<p>The media might not meet HP specifications.</p>	<p>Use a different paper, such as high-quality paper that is intended for laser printers. See <a href="#">Paper and print media on page 45</a>.</p>
	<p>If characters are incorrectly formed so that they produce a wavy effect, the laser scanner might need service.</p>	<p>Verify that the problem also occurs on the configuration page. If so, contact HP. See <a href="http://www.hp.com/support/LJM2727">www.hp.com/support/LJM2727</a> or the support flyer that came in the product box.</p>

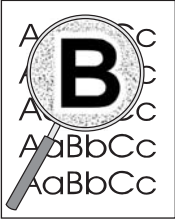
Problem	Cause	Solution
<p>The printed page is curled or wavy.</p> 	The product is not set to print on the type of media on which you want to print.	<p>In the printer driver, make sure the appropriate media type is selected.</p> <p>If the problem persists, select a media type that uses a lower fuser temperature, such as transparencies or light media.</p>
	The media might have been in the input tray too long.	Turn over the stack of media in the tray. Also, try rotating the media 180° in the input tray.
	The paper path is curling the media.	Open the rear output door to print to the straight-through output path.
	The media might not meet HP specifications.	Use a different paper, such as high-quality paper that is intended for laser printers. See <a href="#">Paper and print media on page 45</a> .
	Both high temperature and humidity can cause paper curl.	Check the product environment.
<p>Text or graphics are skewed on the printed page.</p> 	The media might be loaded incorrectly or the input tray might be too full.	Verify that the media is loaded correctly and that the media guides are not too tight or too loose against the stack. See <a href="#">Load paper and print media on page 49</a> .
	The media might not meet HP specifications.	Use a different paper, such as high-quality paper that is intended for laser printers. See <a href="#">Paper and print media on page 45</a> .
<p>The printed page contains wrinkles or creases.</p> 	The media might be loaded incorrectly or the input tray might be too full.	<p>Turn over the stack of paper in the input tray, or try rotating the paper 180° in the input tray.</p> <p>Verify that the media is loaded correctly and that the media guides are not too tight or too loose against the stack. See <a href="#">Load paper and print media on page 49</a>.</p>
	The media might not meet HP specifications.	Use a different paper, such as high-quality paper that is intended for laser printers. See <a href="#">Paper and print media on page 45</a> .
	The paper path is curling the media.	Open the rear output door to print to the straight-through output path.
	Air pockets inside envelopes can cause them to wrinkle.	Remove the envelope, flatten it, and try printing again.

Problem	Cause	Solution
<p>Toner appears around the printed characters.</p> 	<p>The media might be loaded incorrectly.</p> <p>If large amounts of toner have scattered around the characters, the paper might have high resistivity.</p>	<p>Turn over the stack of paper in the tray.</p> <p>Use a different paper, such as high-quality paper that is intended for laser printers. See <a href="#">Paper and print media on page 45</a>.</p>
<p>An image that appears at the top of the page (in solid black) repeats farther down the page (in a gray field).</p> 	<p>Software settings might affect image printing.</p> <hr/> <p>The order of images printed might affect printing.</p> <hr/> <p>A power surge might have affected the product.</p>	<p>In your software program, change the tone (darkness) of the field in which the repeated image appears.</p> <p>In your software program, rotate the whole page 180° to print the lighter image first.</p> <hr/> <p>Change the order in which the images are printed. For example, have the lighter image at the top of the page, and the darker image farther down the page.</p> <hr/> <p>If the defect occurs later in a print job, turn the product off for 10 minutes, and then turn on the product to restart the print job.</p>

## Media-handling problems

Use the information in this section when the product experiences media-handling problems.

### Print-media guidelines

- For best results, make sure that the paper is of good quality, and free of cuts, nicks, tears, spots, loose particles, dust, wrinkles, voids, staples, and curled or bent edges.
- For best-quality printing, use a smooth type of paper. Generally, smoother media produces better results.
- If you are unsure what type of paper you are loading (such as bond or recycled), check the label on the package of paper.
- Do not use media that is designed for inkjet printers only. Use media that is designed for laser printers.
- Do not use letterhead paper that is printed with low-temperature inks, such as those used in some types of thermography.
- Do not use raised or embossed letterhead.
- The product uses heat and pressure to fuse toner to the paper. Make sure that any colored paper or preprinted forms use inks that are compatible with this fusing temperature (200°C or 392°F for 0.1 second).

△ **CAUTION:** Failure to follow these guidelines could cause jams or damage to the product.

## Solve print-media problems

The following problems with media cause print-quality deviations, jamming, or even damage to the product.

Problem	Cause	Solution
Poor print quality or toner adhesion	The paper is too moist, too rough, too heavy or too smooth, or it is embossed or from a faulty paper lot.	Try another kind of paper, between 100 and 250 Sheffield, with 4 to 6% moisture content.
Dropouts, jamming, or curl	The paper has been stored incorrectly.	Store paper flat in its moisture-proof wrapping.
	The paper has variability from one side to the other.	Turn the paper over.
Excessive curl	The paper is too moist, has the wrong grain direction, or is of short-grain construction	Open the rear output bin, or use long-grain paper.
	The paper varies from side-to-side.	Turn the paper over.
	High fuser temperature is curling the paper.	Turn on the <b>Less paper curl</b> setting.  At the control panel, press <b>Setup</b> , use the arrow buttons to select <b>Service</b> , and then press <b>OK</b> . Use the arrow buttons to select <b>Less paper curl</b> , press <b>OK</b> , use the arrow buttons to select <b>On</b> , and then press <b>OK</b> .
Jamming, damage to product	The paper has cutouts or perforations.	Use paper that is free of cutouts or perforations.
Problems with feeding	The paper has ragged edges.	Use high-quality paper that is made for laser printers.
	The paper varies from side-to-side.	Turn the paper over.
	The paper is too moist, too rough, too heavy or too smooth, has the wrong grain direction, or is of short-grain construction or it is embossed or from a faulty paper lot.	Try another kind of paper, between 100 and 250 Sheffield, 4 to 6% moisture content.  Open the rear output bin, or use long-grain paper.
Print is skewed (crooked).	The media guides might be incorrectly adjusted.	Remove all media from the input tray, straighten the stack, and then load the media in the input tray again. Adjust the media guides to the width and length of the media that you are using and try printing again.
More than one sheet feeds at one time.	The media tray might be overloaded.	Remove all media from the tray, and then return some of the media to the tray. See <a href="#">Load paper and print media on page 49</a> .
	The media might be wrinkled, folded, or damaged.	Verify that the media is not wrinkled, folded, or damaged. Try printing on media from a new or different package.
	The media might have been fanned before it was loaded.	Load media that was not fanned. Loosen ream by twisting paper stack.
	Media might be too dry.	Load new paper that was stored properly.

Problem	Cause	Solution
The product does not pull media from the media input tray.	The product might be in manual feed mode.	<ul style="list-style-type: none"> <li>• If <b>Manual feed</b> appears on the product control-panel display, press <b>OK</b> to print the job.</li> <li>• Verify that the product is not in manual feed mode and print your job again.</li> </ul>
	The pickup roller might be dirty or damaged.	Contact HP. See <a href="http://www.hp.com/support/LJM2727">www.hp.com/support/LJM2727</a> or the support flyer that came in the product box.
	The paper-length adjustment control in tray 2 or optional tray 3 is set at a length that is greater than the media size.	Adjust the paper-length adjustment control to the correct length.

## Performance problems

Try the tips in this section if pages exit the product, but have nothing printed on them, or when the product does not print any pages.

Problem	Cause	Solution
Pages print but are totally blank.	The sealing tape might still be in the print cartridge.	Verify that the sealing tape has been completely removed from the print cartridge.
	The document might contain blank pages.	Check the document that you are printing to see if content appears on all of the pages.
	The product might be malfunctioning.	To check the product, print a configuration page. See <a href="#">Information pages on page 142</a> .
	Certain media types can slow the print job.	Print on a different type of media.



Problem	Cause	Solution
Pages did not print.	The product might not be pulling media correctly.	See <a href="#">Media-handling problems on page 194</a> .
	The media might be jamming in the product.	Clear the jam. See <a href="#">Clear jams on page 176</a> .
	The USB cable or the network cable might be defective or incorrectly connected.	<ul style="list-style-type: none"> <li>● Disconnect the cable at both ends and reconnect it.</li> <li>● Try printing a job that has printed in the past.</li> <li>● Try using a different USB or network cable.</li> </ul>
	The product IP address might have been changed.	From the control panel, print a configuration page. Confirm the IP address with that listed in the <b>Properties</b> dialog box.
	The product might not be set up as the default printer.	Open the <b>Printers</b> or <b>Printers and Faxes</b> dialog box, right click the product, and then click <b>Set as Default Printer</b> .
	The product might have encountered an error.	Check the control panel for an error message. See <a href="#">Control-panel messages on page 170</a> .
	The product might be paused or offline.	Open the <b>Printers</b> or <b>Printers and Faxes</b> dialog box, and verify that the product status is Ready. If it is Paused, right-click the product and click <b>Resume Printing</b> .
	The product might not be receiving power.	Check the power cord and verify that the product is turned on.
	Other devices are running on your computer.	The product might not share a USB port. If you have an external hard drive or network switchbox that is connected to the same port as the product, the other device might be interfering. To connect and use the product, disconnect the other device or use two USB ports on the computer.

## Copy problems

### Prevent copy problems

The following are a few simple steps you can take to improve copy quality:

- Copy from the flatbed scanner. This will produce a higher quality copy than copying from the automatic document feeder (ADF).
- Use quality originals.
- Load the media correctly. If the media is loaded incorrectly, it might skew, causing unclear images and problems with the OCR program. See [Load paper and print media on page 49](#) for instructions.
- Use or make a carrier sheet to protect your originals.

 **NOTE:** Verify that the media meets HP specifications. If the media meets HP specifications, recurring feed problems indicate the pickup roller or separation pad is worn. Contact HP. See [www.hp.com/support/LJM2727](http://www.hp.com/support/LJM2727) or the support flyer that came in the product box.

## Image problems

Problem	Cause	Solution
Images are missing or faded.	The print-cartridge might be defective.	Replace the print cartridge. See <a href="#">Print cartridge on page 159</a> .
	The original might be of poor quality.	If your original is too light or damaged, the copy might not be able to compensate, even if you adjust the contrast. If possible, find an original document in better condition.
	The contrast settings might be set incorrectly.	Use the control-panel <b>Lighter/Darker</b> button to change the contrast setting.
	The original might have a colored background.	Colored backgrounds might cause images in the foreground to blend into the background, or the background might appear in a different shade. If possible, use an original document without a colored background.
Vertical white or faded stripes appear on the copy.	The media might not meet HP specifications.	Use media that meets HP specifications. See <a href="#">Paper and print media on page 45</a> .
	The print-cartridge might be defective.	Replace the print cartridge. See <a href="#">Print cartridge on page 159</a> .
	The flatbed scanner or the ADF glass might be dirty.	Clean the flatbed scanner or the ADF glass. See <a href="#">Clean the product on page 162</a> .
	The photosensitive drum inside the print cartridge might have been scratched.	Install a new HP print cartridge. See <a href="#">Print cartridge on page 159</a> .
Black dots or streaks appear on the copy.	Ink, glue, correction fluid, or an unwanted substance might be on the automatic document feeder (ADF) or flatbed scanner.	Clean the product. See <a href="#">Clean the product on page 162</a> .
	The power to the product might have fluctuated.	Reprint the job.
Copies are too light or dark.	The printer driver or product software settings may be incorrect.	Verify that the quality settings are correct.
		See the product software Help for more information about changing the settings.
Text is unclear.	The printer driver or product software settings may be incorrect.	Verify that the quality settings are correct.
		Verify that the EconoMode setting is off.
		See the product software Help for more information about changing the settings.

## Media-handling problems

Problem	Cause	Solution
Poor print quality or toner adhesion	The paper is too moist, too rough, too heavy or too smooth, or it is embossed or from a faulty paper lot.	Try another kind of paper, between 100 and 250 Sheffield, 4 to 6% moisture content.
Dropouts, jamming, or curl	The paper has been stored incorrectly.	Store paper flat in its moisture-proof wrapping.
	The paper has variability from one side to the other.	Turn the paper over.
Excessive curl	The paper is too moist, has the wrong grain direction, or is of short-grain construction	Open the rear output bin, or use long-grain paper.
	The paper varies from side-to-side.	Turn the paper over.
Jamming, damage to paper	The paper has cutouts or perforations.	Use paper that is free of cutouts or perforations.
Problems with feeding	The paper has ragged edges.	Use high-quality paper that is made for laser printers.
	The paper varies from side-to-side.	Turn the paper over.
	The paper is too moist, too rough, too heavy or too smooth, has the wrong grain direction, or is of short-grain construction or it is embossed or from a faulty paper lot.	Try another kind of paper, between 100 and 250 Sheffield, 4 to 6% moisture content.  Open the rear output bin, or use long-grain paper.
Print is skewed (crooked).	The media guides might be incorrectly adjusted.	Remove all media from the input tray, straighten the stack, and then load the media in the input tray again. Adjust the media guides to the width and length of the media that you are using and try printing again.
More than one sheet feeds at one time.	The media tray might be overloaded.	Remove some of the media from the tray. See <a href="#">Load paper and print media on page 49</a> .
	The media might be wrinkled, folded, or damaged.	Verify that the media is not wrinkled, folded, or damaged. Try printing on media from a new or different package.
The product does not pull media from the media input tray.	The product might be in manual feed mode.	<ul style="list-style-type: none"> <li>If <b>Manual</b> appears on the product control-panel display, press <b>OK</b> to print the job.</li> <li>Verify that the product is not in manual feed mode and print your job again.</li> </ul>
	The pickup roller might be dirty or damaged.	Contact HP. See <a href="http://www.hp.com/support/LJM2727">www.hp.com/support/LJM2727</a> or the support flyer that came in the product box.
	The paper-length adjustment control in tray 2 or optional tray 3 is set at a length that is greater than the media size.	Adjust the paper-length adjustment control to the correct length.

## Performance problems

Problem	Cause	Solution
No copy came out.	The input tray might be empty.	Load media in the product. See <a href="#">Load paper and print media on page 49</a> for more information.
	The original might have been loaded incorrectly.	In the automatic document feeder (ADF), load the original with the narrow side forward and the side to be scanned facing up.  On the flatbed scanner, place the original document face-down with the upper-left corner of the document at the lower-right corner of the glass.
Copies are blank.	The sealing tape might not have been removed from the print cartridge.	Remove the print cartridge from the product, pull out the sealing tape, and reinstall the print cartridge.
	The original might have been loaded incorrectly.	In the ADF, load the original with the narrow side leading into the ADF and the side to be scanned facing up.  On the flatbed scanner, make sure that the original document is placed face-down with the upper-left corner of the document at the lower-right corner of the glass.
	The media might not meet HP specifications.	Use media that meets HP specifications. See <a href="#">Paper and print media on page 45</a> .
	The print cartridge might be defective.	Replace the print cartridge. See <a href="#">Print cartridge on page 159</a> .
The wrong original was copied.	The ADF might be loaded.	Make sure that the ADF is empty.
Copies are reduced in size.	The product settings might be set to reduce the scanned image.	On the control panel, press <b>Reduce/Enlarge</b> and verify that it is set to <b>Original=100%</b> .

# Scan problems

## Solve scanned-image problems

Problem	Cause	Solution
The scanned image is of poor quality.	The original might be a second-generation photo or picture.	<ul style="list-style-type: none"><li>• To eliminate the patterns, try reducing the size of the image after scanning.</li><li>• Print the scanned image to see if the quality is better.</li><li>• Verify that the resolution settings are correct for the type of scan job that you are performing. See <a href="#">Scanner resolution and color on page 87</a>.</li><li>• For best results, use the flatbed scanner for scanning rather than the automatic document feeder (ADF).</li></ul>
	The image that appears on the screen might not be an accurate representation of the quality of the scan.	<ul style="list-style-type: none"><li>• Try adjusting your computer monitor settings to use more colors (or levels of gray). Typically, you make this adjustment by opening <b>Display</b> in Windows Control Panel.</li><li>• Try adjusting the resolution settings in the scanner software. See <a href="#">Scanner resolution and color on page 87</a>.</li></ul>
	The original might have been loaded incorrectly.	Use the media guides when you load the originals into the ADF. See <a href="#">Load paper and print media on page 49</a> .
	The scanner might be dirty.	Clean the scanner. See <a href="#">Clean the scanner glass on page 88</a> .
	The graphics settings might not be suitable for the type of scan job that you are performing.	Try changing the graphics settings. See <a href="#">Scanner resolution and color on page 87</a> .

Problem	Cause	Solution
Part of the image did not scan.	The original might have been loaded incorrectly.	Use the media guides when you load the originals into the ADF. See <a href="#">Load originals for scanning on page 82</a> .
	A colored background might be causing images in the foreground to blend into the background.	Try adjusting the settings before you scan the original or enhancing the image after you scan the original.
	The original is longer than 381 mm (15 inches).	The maximum scannable length is 381 mm (15 inches) when you use the automatic document feeder (ADF) input tray. If the page exceeds the maximum length, the scanner stops. (Copies can be longer.)  <b>CAUTION:</b> Do not try to pull the original from the ADF; you might damage the scanner or your original. See <a href="#">Clear jams from the ADF on page 177</a> .
	The original is too small.	The minimum size that the flatbed scanner supports is 25 x 25 mm (1 x 1 inch). The minimum size that the ADF supports is 127 x 127 mm (5 x 5 inches). The original might be jammed. See <a href="#">Clear jams from the ADF on page 177</a> .
	The media size is incorrect.	In <b>Scan</b> settings, make sure that the input media size is large enough for the document that you are scanning. .
The scan takes too long	The resolution or color level is set too high.	Change the resolution and color settings to the correct settings for your job. See <a href="#">Scanner resolution and color on page 87</a> .
	The software is set to scan in color.	The system default is color, which takes longer to scan even when scanning a monochrome original. If you acquire an image through TWAIN or WIA, you can change the settings so that the original scans in grayscale or black-and-white. See the product software Help for details.
	A print job or copy job was sent before you tried to scan.	If someone sent a print job or copy job before you tried to scan, the scan will start if the scanner is not busy. However, because the product and scanner share memory, the scan might be slower.

## Scan-quality problems

### Prevent scan-quality problems

The following are a few simple steps you can take to improve copy and scan quality.

- Use the flatbed scanner, rather than the automatic document feeder (ADF) input tray, to scan.
- Use high-quality originals.
- Load the media correctly. If the media is loaded incorrectly, it might skew, which causes unclear images. See [Load paper and print media on page 49](#) for instructions.
- Adjust the software settings according to how you plan to use the scanned page. See [Scanner resolution and color on page 87](#) for more information.
- If your product frequently feeds more than one page at a time, the separation pad might need to be replaced. Contact HP. See [www.hp.com/support/LJM2727](http://www.hp.com/support/LJM2727) or the support flyer that came in the product box.
- Use or make a carrier sheet to protect your originals.

### Solve scan-quality problems

Problem	Cause	Solution
Blank pages	The original might have been loaded upside down.	In the automatic document feeder (ADF), put the top end of the stack of originals into the ADF input tray, with the media stack face-up and the first page to be scanned on top of the stack.
		On the flatbed scanner, place the original document face-down with the upper-left corner of the document at the lower-right corner of the glass.
Too light or dark	The resolution and color levels may be set incorrectly.	Verify that you have the correct resolution and color settings. See <a href="#">Scanner resolution and color on page 87</a> .
Unwanted lines	Ink, glue, correction fluid, or an unwanted substance might be on the glass.	Clean the flatbed scanner surface. See <a href="#">Clean the scanner glass on page 88</a> .
	The ADF glass might be dirty.	Clean the scanner strip. See <a href="#">Clean the scanner glass on page 88</a> (step 3).
Black dots or streaks	Ink, glue, correction fluid, or an unwanted substance might be on the glass.	Clean the flatbed scanner surface. See <a href="#">Clean the scanner glass on page 88</a> .
	The power to the product might have fluctuated.	Reprint the job.
Unclear text	The resolution levels might be set incorrectly.	Verify that the correct resolution settings are correct. See <a href="#">Scanner resolution and color on page 87</a> .

## Fax problems

To solve fax issues, see [Solve fax problems on page 129](#).

## Optimize and improve image quality

### Print-quality checklist

General print-quality problems can be solved by using the following checklist:

1. Make sure that the paper or print media that you are using meets specifications. See [Paper and print media on page 45](#). Generally, smoother paper provides better results.
2. If you are using a special print media such as labels, transparencies, glossy, or letterhead, ensure that you have printed by type. See [Change the print driver to match the media type and size on page 54](#).
3. Print a configuration page and supplies status page at the product control panel. See [Information pages on page 142](#).
  - Check the supplies status page to see if any supplies are low or empty. No information is provided for non-HP print cartridges.
  - If the pages do not print correctly, the problem is with the hardware. Contact HP. See [www.hp.com/support/LJM2727](http://www.hp.com/support/LJM2727) or the support flyer that came in the product box.
4. Print a demo page from HP ToolboxFX. If the page prints, the problem is with the printer driver. Try printing from another printer driver. For example, if you are using the PCL 6 printer driver, print from the PS printer driver.
  - Use the Add Printer Wizard in the **Printers** (or **Printers and Faxes** in Windows XP) dialog box to install the PS driver.
5. Try printing from a different program. If the page prints correctly, the problem is with the program from which you were printing.
6. Restart the computer and the product and try printing again. If the problem is not resolved, see [General print-quality issues on page 190](#).

### Manage and configure printer drivers

Print-quality settings affect how light or dark the print is on the page and the style in which the graphics are printed. You can also use the print-quality settings to optimize the print quality for a specific media type.

You can change the settings in the product properties to accommodate the types of jobs that you are printing. The following settings are available, depending on the printer driver that you are using:

- **600 dpi**
- **Custom:** This setting produces the same resolution as the default setting, but you can change the scale patterns.

---

 **NOTE:** Changing the resolution can change the formatting of your text.

---

### Temporarily change print-quality settings

To change the print-quality settings only for the current software program, open the properties through the **Print Setup** menu in the program that you are using to print.



## Change print-quality settings for all future jobs



**NOTE:** For Macintosh instructions, see [Change printer-driver settings for Macintosh on page 28](#).

---

For Windows 2000:

1. In the Windows system tray, click **Start**, select **Settings**, and then click **Printers**.
2. Right-click the product icon.
3. Click **Properties** or **Printing Preferences**.
4. Change the settings, and click **OK**.

For Windows XP:

1. In the Windows system tray, click **Start**, click **Control Panel**, and then click **Printers and Faxes**.
2. Right-click the product icon.
3. Click **Properties**, or click **Printing Preferences**.
4. Change the settings, and click **OK**.

For Windows Vista:

1. In the Windows system tray, click **Start**, click **Control Panel**, and then, under **Hardware and Sound**, click **Printer**.
2. Right-click the product icon.
3. Click **Properties**, or click **Printing Preferences**.
4. Change the settings, and click **OK**.

## Solve convenience stapler problems

The convenience stapler is designed to be free of staple jams. To reduce the risk of staple jams, make sure that you staple 20 or fewer pages of media (80 g/m<sup>2</sup> or 20 lb) at a time.

Problem	Cause	Solution
The convenience stapler does not staple pages.	The stapler door is not completely closed.	The convenience stapler has a staple jam.
	Make sure that the stapler door is completely closed.	Clear the staple jam. See <a href="#">Clear jams from the convenience stapler (HP LaserJet M2727nfs mfp only) on page 188</a> .

## Solve connectivity problems

### Solve direct-connection problems

If the product is experiencing connection issues while directly connected to a computer, complete the following steps:

1. Make sure that USB cable is no longer than 2 meters (6 feet).
2. Make sure that both ends of the USB cable are connected.
3. Make sure that the cable is a USB 2.0 Hi-Speed-certified cable.
4. If the error persists, use a different USB cable.

### Network problems

#### Verify that the product is on and online

Check the following items to make sure the product is ready to print.

1. Is the product plugged in and turned on?  
Make sure that the product is plugged in and turned on. If the problem persists, you might have a defective power cable, power source, or product.
2. Is the product **Ready** light on?  
If the light is blinking, you might need to wait until the current job is completed.
3. Is the product control-panel display blank?
  - Make sure the product is turned on.
  - Make sure the product is installed correctly.
4. Does a message other than **Ready** appear on the product control-panel display?
  - See your product documentation for a complete list of control panel messages and corrective actions.

## Resolve communication problems with the network

Check the following items to verify that the product is communicating with the network. This information assumes you have already printed a network configuration page (see [Information pages on page 142](#)).

1. Are there any physical connection problems between the workstation or file server and the product?

Verify that the network cabling, connections, and router configurations are correct. Verify that the network cable lengths meet network specifications.

2. Are the network cables connected properly?

Make sure that the product is attached to the network using the appropriate port and cable. Check each cable connection to make sure it is secure and in the right place. If the problem continues, try a different cable or ports on the hub or transceiver. The amber activity light and the green link status light next to the port connection on the back of the product should be lit.

3. Are the product link speed and duplex settings set correctly?

Hewlett-Packard recommends leaving this setting in automatic mode (the default setting).

4. Can you "ping" the product IP address?

Use the command prompt to ping the product from the computer. For example:

```
ping 192.168.45.39
```

Ensure that the ping displays round-trip times.

If you are able to ping the product, verify that the IP address configuration for the product is correct on the computer. If it is correct, delete and then add the product again.

If the ping command failed, verify that the network hubs are on, and then verify that the network settings, the product, and the computer are all configured for the same network.

5. Have any software programs been added to the network?

Make sure they are compatible and that they are installed correctly with the correct printer drivers.

6. Are other users able to print?

The problem may be workstation-specific. Check the workstation network drivers, printer drivers, and redirection.

7. If other users are able to print, are they using the same network operating system?

Check your system for proper network operating system setup.

8. Is your protocol enabled?

Check the status of your protocol on the network configuration page. See [Information pages on page 142](#). You can also use the embedded Web server or HP ToolboxFX to check the status of other protocols. See [HP ToolboxFX on page 144](#).

# Solve software problems

## Solve common Windows problems

Error message:

"General Protection FaultException OE"

"Spool32"

"Illegal Operation"

Cause	Solution
	Close all software programs, restart Windows, and try again.
	Select a different printer driver. If the device PCL 6 printer driver is selected, switch to the PCL 5 or HP postscript level 3 emulation printer driver, which can be done from a software program.
	Delete all temp files from the Temp subdirectory. Determine the name of the directory by opening the AUTOEXEC.BAT file and looking for the statement "Set Temp =". The name after this statement is the Temp directory. It is usually C:\TEMP by default, but can be redefined.
	See the Microsoft Windows documentation that came with the computer for more information about Windows error messages.

## Solve common Macintosh problems

Table 12-3 Problems with Mac OS X v10.3 and Mac OS X v10.4

The printer driver is not listed in Printer Setup Utility.

Cause	Solution
The product software might not have been installed or was installed incorrectly.	Make sure that the PPD is in the following hard drive folder: Library/Printers/PPDs/Contents/Resources/<lang>.lproj, where "<lang>" represents the two-letter language code for the language that you are using. If necessary, reinstall the software. See the getting started guide for instructions.
The Postscript Printer Description (PPD) file is corrupt.	Delete the PPD file from the following hard drive folder: Library/Printers/PPDs/Contents/Resources/<lang>.lproj, where "<lang>" represents the two-letter language code for the language that you are using. Reinstall the software. See the getting started guide for instructions.

The product name, IP address, or "Rendezvous" or "Bonjour" host name does not appear in the printer list box in the Printer Setup Utility.

Cause	Solution
The product might not be ready.	Make sure that the cables are connected correctly, the product is on, and the ready light is on. If you are connecting through a USB or

**Table 12-3 Problems with Mac OS X v10.3 and Mac OS X v10.4 (continued)**

**The product name, IP address, or “Rendezvous” or “Bonjour” host name does not appear in the printer list box in the Printer Setup Utility.**

Cause	Solution
	Ethernet hub, try connecting directly to the computer or use a different port.
The wrong product name, IP address, or "Rendezvous" or "Bonjour" host name is being used.	Check the product name, IP address, or "Rendezvous" or "Bonjour" host name by printing a configuration page See <a href="#">Information pages on page 142</a> . Verify that the name, IP address, or "Rendezvous" or "Bonjour" host name on the configuration page matches the product name, IP address, or "Rendezvous" or "Bonjour" host name in the Printer Setup Utility.
The interface cable might be defective or of poor quality.	Replace the interface cable. Make sure to use a high-quality cable.

**A print job was not sent to the product that you wanted.**

Cause	Solution
The print queue might be stopped.	Open the print queue, and then click <b>Start Jobs</b> .
The wrong product name or IP address is being used. Another product with the same or similar name, IP address, or "Rendezvous" or "Bonjour" host name might have received your print job.	Check the product name, IP address, or "Rendezvous" or "Bonjour" host name by printing a configuration page See <a href="#">Information pages on page 142</a> . Verify that the name, IP address, or "Rendezvous" or "Bonjour" host name on the configuration page matches the product name, IP address, or "Rendezvous" or "Bonjour" host name in the Printer Setup Utility.

**An encapsulated PostScript (EPS) file does not print with the correct fonts.**

Cause	Solution
This problem occurs with some programs.	<ul style="list-style-type: none"><li>● Try downloading the fonts that are contained in the EPS file to the product before printing.</li><li>● Send the file in ASCII format instead of binary encoding.</li></ul>

**You are unable to print from a third-party USB card.**

Cause	Solution
This error occurs when the software for USB printers is not installed.	When adding a third-party USB card, you might need the Apple USB Adapter Card Support software. The most current version of this software is available from the Apple Web site.

**Table 12-3 Problems with Mac OS X v10.3 and Mac OS X v10.4 (continued)**

When connected with a USB cable, the product does not appear in the Macintosh Printer Setup Utility after the driver is selected.

Cause	Solution
This problem is caused by either a software or a hardware component.	<p><b>Software troubleshooting</b></p> <ul style="list-style-type: none"> <li>• Check that your Macintosh supports USB.</li> <li>• Verify that your Macintosh operating system is Mac OS X v10.3 or Mac OS X v10.4.</li> <li>• Ensure that your Macintosh has the appropriate USB software from Apple.</li> </ul> <p><b>Hardware troubleshooting</b></p> <ul style="list-style-type: none"> <li>• Check that the product is turned on.</li> <li>• Verify that the USB cable is connected correctly.</li> <li>• Check that you are using the appropriate high-speed USB cable.</li> <li>• Ensure that you do not have too many USB devices drawing power from the chain. Disconnect all of the devices from the chain, and connect the cable directly to the USB port on the host computer.</li> <li>• Check to see if more than two nonpowered USB hubs are connected in a row on the chain. Disconnect all of the devices from the chain and connect the cable directly to the USB port on the host computer.</li> </ul> <p><b>NOTE:</b> The iMac keyboard is a nonpowered USB hub.</p>

## Solve PostScript (PS) errors

The following situations are PS language specific and may occur when several product languages are being used.

 **NOTE:** To receive a printed or screen displayed message when PS errors occur, open the **Print Options** dialog box and click the selection next to the PS Errors section. You can also use the embedded Web server.

**Table 12-4 PS errors**

Issue	Cause	Solution
The job prints in Courier (the product's default typeface) instead of the typeface you requested.	The requested typeface is not downloaded. A personality switch may have been performed to print a PCL job just before the PS printing job was received.	Download the desired font and send the print job again. Verify the type and location of the font. Download to the product if applicable. Check with the software documentation.
A legal page prints with clipped margins.	Print job too complex.	You may need to print your job at 600 dots per inch, reduce the complexity of the page, or install more memory.
A PS error page prints.	Print job may not be PS.	Make sure the print job is a PS job. Check to see whether the software program expected a setup or PS header file to be sent to the product.

**Table 12-4 PS errors (continued)**

<b>Issue</b>	<b>Cause</b>	<b>Solution</b>
Limit Check Error	Print job is too complex.	You may need to print your job at 600 dots per inch, reduce the complexity of the page, or install more memory.
VM Error	Font Error	Select unlimited downloadable fonts from printer driver.
Range Check	Font Error	Select unlimited downloadable fonts from printer driver.





---

# A Accessories and ordering information

- To order supplies in the U.S., go to [www.hp.com/sbso/product/supplies](http://www.hp.com/sbso/product/supplies).
- To order supplies worldwide, go to [www.hp.com/ghp/buyonline.html](http://www.hp.com/ghp/buyonline.html).
- To order supplies in Canada, go to [www.hp.ca/catalog/supplies](http://www.hp.ca/catalog/supplies).
- To order supplies in Europe, go to [www.hp.com/go/ljsupplies](http://www.hp.com/go/ljsupplies).
- To order supplies in Asia-Pacific, go to [www.hp.com/paper/](http://www.hp.com/paper/).
- To order accessories, go to [www.hp.com/go/accessories](http://www.hp.com/go/accessories).

## Supplies

Product name	Description	Part number
Black print cartridge	Average yield for the standard print cartridge is approximately 3,000 pages.	Standard: Standard: Q7553A
	Average yield for the extended-life print cartridge is approximately 7,000 pages. Actual yield depends on use.	Extended life: Extended life: Q7553X

## Memory

Product name	Description	Part number
Memory upgrades (DIMMs)	64 MB	CB421A
	128 MB	CB422A
	256 MB	CB423A

## Cable and interface accessories

Product name	Description	Part number
USB cable	2-meter standard USB-compatible device connector	C6518A
	3-meter standard USB-compatible device connector	C6520A
Fax cord	Two-wire phone cord adapter	8121-0811
HP Wireless Printing Upgrade Kit	Printer adapter for wireless point-to-point printing.	Q6259A

## Paper-handling accessories

Product name	Description	Part number
Optional tray 3	250-sheet input tray for standard sizes.	Q7556A
Stapler cartridge pack	1,500-staple capacity	Q7432A

## User-replaceable parts

Product name	Description	Part number
Separation pad and pickup rollers	Replace when the product is picking up multiple sheets or no sheets. Trying different paper did not resolve the problem.	Contact HP Customer Care to order parts.
Automatic document feeder (ADF)	Replace when the ADF is damaged or not working correctly.	Contact HP Customer Care to order parts.



---

## B Service and support

### Hewlett-Packard limited warranty statement

HP PRODUCT

HP LaserJet M2727nf and M2727nfs

DURATION OF LIMITED WARRANTY

One-year limited warranty

HP warrants to you, the end-user customer, that HP hardware and accessories will be free from defects in materials and workmanship after the date of purchase, for the period specified above. If HP receives notice of such defects during the warranty period, HP will, at its option, either repair or replace products which prove to be defective. Replacement products may be either new or equivalent in performance to new.

HP warrants to you that HP software will not fail to execute its programming instructions after the date of purchase, for the period specified above, due to defects in material and workmanship when properly installed and used. If HP receives notice of such defects during the warranty period, HP will replace software which does not execute its programming instructions due to such defects.

HP does not warrant that the operation of HP products will be uninterrupted or error free. If HP is unable, within a reasonable time, to repair or replace any product to a condition as warranted, you will be entitled to a refund of the purchase price upon prompt return of the product.

HP products may contain remanufactured parts equivalent to new in performance or may have been subject to incidental use.

Warranty does not apply to defects resulting from (a) improper or inadequate maintenance or calibration, (b) software, interfacing, parts or supplies not supplied by HP, (c) unauthorized modification or misuse, (d) operation outside of the published environmental specifications for the product, or (e) improper site preparation or maintenance.

TO THE EXTENT ALLOWED BY LOCAL LAW, THE ABOVE WARRANTIES ARE EXCLUSIVE AND NO OTHER WARRANTY OR CONDITION, WHETHER WRITTEN OR ORAL, IS EXPRESSED OR IMPLIED AND HP SPECIFICALLY DISCLAIMS ANY IMPLIED WARRANTIES OR CONDITIONS OF MERCHANTABILITY, SATISFACTORY QUALITY, AND FITNESS FOR A PARTICULAR PURPOSE. Some countries/regions, states or provinces do not allow limitations on the duration of an implied warranty, so the above limitation or exclusion might not apply to you. This warranty gives you specific legal rights and you might also have other rights that vary from country/region to country/region, state to state, or province to province. HP's limited warranty is valid in any country/region or locality where HP has a support presence for this product and where HP has marketed this product. The level of warranty service you receive may vary according to local standards. HP will not alter form, fit or function of the product to make it operate in a country/region for which it was never intended to function for legal or regulatory reasons.

TO THE EXTENT ALLOWED BY LOCAL LAW, THE REMEDIES IN THIS WARRANTY STATEMENT ARE YOUR SOLE AND EXCLUSIVE REMEDIES. EXCEPT AS INDICATED ABOVE, IN NO EVENT WILL HP OR ITS SUPPLIERS BE LIABLE FOR LOSS OF DATA OR FOR DIRECT, SPECIAL, INCIDENTAL, CONSEQUENTIAL

(INCLUDING LOST PROFIT OR DATA), OR OTHER DAMAGE, WHETHER BASED IN CONTRACT, TORT, OR OTHERWISE. Some countries/regions, states or provinces do not allow the exclusion or limitation of incidental or consequential damages, so the above limitation or exclusion may not apply to you.

THE WARRANTY TERMS CONTAINED IN THIS STATEMENT, EXCEPT TO THE EXTENT LAWFULLY PERMITTED, DO NOT EXCLUDE, RESTRICT OR MODIFY AND ARE IN ADDITION TO THE MANDATORY STATUTORY RIGHTS APPLICABLE TO THE SALE OF THIS PRODUCT TO YOU.

## Customer self repair warranty service

HP products are designed with many Customer Self Repair (CSR) parts to minimize repair time and allow for greater flexibility in performing defective parts replacement. If during the diagnosis period, HP identifies that the repair can be accomplished by the use of a CSR part, HP will ship that part directly to you for replacement. There are two categories of CSR parts: 1) Parts for which customer self repair is mandatory. If you request HP to replace these parts, you will be charged for the travel and labor costs of this service. 2) Parts for which customer self repair is optional. These parts are also designed for Customer Self Repair. If, however, you require that HP replace them for you, this may be done at no additional charge under the type of warranty service designated for your product.

Based on availability and where geography permits, CSR parts will be shipped for next business day delivery. Same-day or four-hour delivery may be offered at an additional charge where geography permits. If assistance is required, you can call the HP Technical Support Center and a technician will help you over the phone. HP specifies in the materials shipped with a replacement CSR part whether a defective part must be returned to HP. In cases where it is required to return the defective part to HP, you must ship the defective part back to HP within a defined period of time, normally five (5) business days. The defective part must be returned with the associated documentation in the provided shipping material. Failure to return the defective part may result in HP billing you for the replacement. With a customer self repair, HP will pay all shipping and part return costs and determine the courier/carrier to be used.

## Print cartridge limited warranty statement

This HP product is warranted to be free from defects in materials and workmanship.

This warranty does not apply to products that (a) have been refilled, refurbished, remanufactured or tampered with in any way, (b) experience problems resulting from misuse, improper storage, or operation outside of the published environmental specifications for the device product or (c) exhibit wear from ordinary use.

To obtain warranty service, please return the product to place of purchase (with a written description of the problem and print samples) or contact HP customer support. At HP's option, HP will either replace products that prove to be defective or refund your purchase price.

TO THE EXTENT ALLOWED BY LOCAL LAW, THE ABOVE WARRANTY IS EXCLUSIVE AND NO OTHER WARRANTY OR CONDITION, WHETHER WRITTEN OR ORAL, IS EXPRESSED OR IMPLIED AND HP SPECIFICALLY DISCLAIMS ANY IMPLIED WARRANTIES OR CONDITIONS OF MERCHANTABILITY, SATISFACTORY QUALITY, AND FITNESS FOR A PARTICULAR PURPOSE.

TO THE EXTENT ALLOWED BY LOCAL LAW, IN NO EVENT WILL HP OR ITS SUPPLIERS BE LIABLE FOR DIRECT, SPECIAL, INCIDENTAL, CONSEQUENTIAL (INCLUDING LOST PROFIT OR DATA), OR OTHER DAMAGE, WHETHER BASED IN CONTRACT, TORT, OR OTHERWISE.

THE WARRANTY TERMS CONTAINED IN THIS STATEMENT, EXCEPT TO THE EXTENT LAWFULLY PERMITTED, DO NOT EXCLUDE, RESTRICT OR MODIFY AND ARE IN ADDITION TO THE MANDATORY STATUTORY RIGHTS APPLICABLE TO THE SALE OF THIS PRODUCT TO YOU.

# HP Customer Care

## Online Services

For 24-hour access to updated HP device-specific software, product information, and support information through an Internet connection, go to the Web site: [www.hp.com/support/LJM2727](http://www.hp.com/support/LJM2727).

HP Instant Support Professional Edition (ISPE) is a suite of Web-based troubleshooting tools for desktop computing and printing products. Go to [instantsupport.hp.com](http://instantsupport.hp.com).

## Telephone support

HP provides free telephone support during the warranty period. For the telephone number for your country/region, see the flyer that shipped with the device, or visit [www.hp.com/support/](http://www.hp.com/support/). Before calling HP, have the following information ready: the product name and serial number, the date of purchase, and a description of the problem.

## Software utilities, drivers, and electronic information

[www.hp.com/go/LJM2727\\_software](http://www.hp.com/go/LJM2727_software)

The Web page for the drivers is in English, but you can download the drivers themselves in several languages.

## HP direct ordering for accessories or supplies

- United States: [www.hp.com/sbso/product/supplies](http://www.hp.com/sbso/product/supplies).
- Canada: [www.hp.ca/catalog/supplies](http://www.hp.ca/catalog/supplies)
- Europe: [www.hp.com/go/ljsupplies](http://www.hp.com/go/ljsupplies)
- Asia-Pacific: [www.hp.com/paper/](http://www.hp.com/paper/)

To order genuine HP parts or accessories, go to the HP Parts Store at [www.hp.com/buy/parts](http://www.hp.com/buy/parts) (U.S. and Canada only), or call 1-800-538-8787 (U.S.) or 1-800-387-3154 (Canada).

## HP service information

To locate HP-Authorized Dealers, call 1-800-243-9816 (U.S.) or 1-800-387-3867 (Canada).

Outside the United States and Canada, call the customer support number for your country/region. See the flyer that shipped in the box with the device.

## HP service agreements

Call 1-800-HPINVENT (1-800-474-6836 (U.S.)) or 1-800-268-1221 (Canada). Or, go to the HP SupportPack and Carepaq™ Services Web site at [www.hpexpress-services.com/10467a](http://www.hpexpress-services.com/10467a).

For extended service, call 1-800-446-0522.



## HP ToolboxFX

To check the device status and settings and view troubleshooting information and online documentation, use the HP ToolboxFX. You must have performed a full software installation in order to use the HP ToolboxFX. See [HP ToolboxFX on page 144](#).

## HP support and information for Macintosh computers

Go to [www.hp.com/go/macosex](http://www.hp.com/go/macosex) for Macintosh OS X support information and HP subscription service for driver updates.

Go to [www.hp.com/go/mac-connect](http://www.hp.com/go/mac-connect) for products that are designed specifically for the Macintosh user.

## HP maintenance agreements

HP has several types of maintenance agreements that meet a wide range of support needs. Maintenance agreements are not part of the standard warranty. Support services may vary by area. Check with your local HP dealer to determine the services available to you.

### On-site service agreements

To provide you with the level of support best suited to your needs, HP has on-site service agreements with a selection of response times.

#### Next-day on-site service

This agreement provides support by the next working day following a service request. Extended coverage hours and extended travel beyond HP's designated service zones are available on most on-site agreements (for additional charges).

#### Weekly (volume) on-site service

This agreement provides scheduled weekly on-site visits for organizations with many HP products. This agreement is designated for sites using 25 or more workstation products, including devices, plotters, computers, and disk drives.

### Repacking the device

If HP Customer Care determines that your device needs to be returned to HP for repair, follow the steps below to repack the device before shipping it.

---

△ **CAUTION:** Shipping damage as a result of inadequate packing is the customer's responsibility.

---

## To repack the device

1. Remove and retain any DIMMs cards that you have purchased and installed in the device. Do not remove the DIMM that came with the device.  

---

△ **CAUTION:** Static electricity can damage DIMMs. When handling DIMMs, either wear an antistatic wrist strap, or frequently touch the surface of the DIMM antistatic package and then touch bare metal on the device. To remove the DIMMs, see [Memory DIMMs on page 160](#).

---
2. Remove and retain the print cartridge.  

---

△ **CAUTION:** It is *extremely important* to remove the print cartridge before shipping the device. A print cartridge that remains in the device during shipping will leak and entirely cover the device engine and other parts with toner.

To prevent damage to the print cartridge, avoid touching the roller on it, and store the print cartridge in its original packing material or so that it is not exposed to light.

---
3. Remove and retain the power cable, interface cable, and optional accessories.
4. If possible, include print samples and 50 to 100 sheets of paper or other print media that did not print correctly.
5. In the U.S., call HP Customer Care to request new packing material. In other areas, use the original packing material, if possible. Hewlett-Packard recommends insuring the equipment for shipment.

## Extended warranty

HP Support provides coverage for the HP hardware product and all HP-supplied internal components. The hardware maintenance covers a 1- to 3-year period from date of the HP product purchase. The customer must purchase HP Support within the stated factory warranty. For more information, contact the HP Customer Care Service and Support group.

---

# C Specifications

This section contains the following information about the product:

- [Physical specifications](#)
- [Electrical specifications](#)
- [Power consumption](#)
- [Environmental specifications](#)
- [Acoustic emissions](#)

## Physical specifications

**Table C-1 Physical specifications**

Product	Height	Depth	Width	Weight
HP LaserJet M2727nf	690 mm (27.2 inches)	650 mm (25.6 inches)	500 mm (19.7 inches)	17.2 kg (37.8 lb)
HP LaserJet M2727nfs	780 mm (30.7 inches)	650 mm (25.6 inches)	500 mm (19.7 inches)	20.5 kg (44.9 lb)

## Electrical specifications

- △ **CAUTION:** Power requirements are based on the country/region where the product is sold. Do not convert operating voltages. This will damage the product and void the product warranty.

**Table C-2 Electrical specifications**

Item	110-volt models	230-volt models
Power requirements	110 to 127 V (+/- 10%)	220 to 240 V (+/- 10%)
	50 / 60 Hz (+/- 2 Hz)	50 / 60 Hz (+/- 2 Hz)
Rated current	4.9 A	2.9 A

## Power consumption

**Table C-3 Power consumption (average, in watts)<sup>1</sup>**

Product model	Printing <sup>2</sup>	Copying <sup>2</sup>	Ready/Sleep <sup>3</sup>	Off
HP LaserJet M2727nf	410 W	410 W	13 W	<0.1 W
HP LaserJet M2727nfs	410 W	410 W	13 W	<0.1 W

<sup>1</sup> Values are based on preliminary data. See [www.hp.com/support/LJM2727](http://www.hp.com/support/LJM2727) for current information.

<sup>2</sup> Power reported is highest values measured using all standard voltages.

<sup>3</sup> Instant on fuser technology.

<sup>4</sup> Recovery time from Ready/Sleep to start of printing = 8.5 seconds.

<sup>5</sup> Maximum heat dissipation for all models in Ready mode = 45 BTU/hour

# Environmental specifications

**Table C-4 Environmental specifications<sup>1</sup>**

	Recommended	Operating	Storage
Temperature	15° to 32.5° C (59° to 90.5° F)	15° to 32.5° C (59° to 90.5° F)	-20° to 40° C (-4° to 104° F)
Relative humidity	10% to 80%	10% to 80%	95% or less

<sup>1</sup> Values are subject to change.

# Acoustic emissions

**Table C-5 Acoustic emissions**

Sound Power Level	Declared per ISO 9296 <sup>1</sup>
Printing (26 ppm)	$L_{WA_d} = 6.4$ Bels (A) [64 dB (A)]
Ready	Inaudible
Sound Pressure Level - Bystander Position	Declared per ISO 9296 <sup>1</sup>
Printing (26 ppm)	$L_{pA_m} = 50$ dB(A)
Ready	Inaudible

<sup>1</sup> Values are based on preliminary data. See [www.hp.com/support/LJM2727](http://www.hp.com/support/LJM2727) for current information.

<sup>2</sup> Configuration tested: HP LaserJet M2727nf printing simplex using A4 paper at 26 ppm.



---

## D Regulatory information

This section contains the following regulatory information:

- [FCC compliance](#)
- [Environmental product stewardship program](#)
- [Telephone Consumer Protection Act \(United States\)](#)
- [IC CS-03 requirements](#)
- [EU statement for telecom operation](#)
- [New Zealand telecom statements](#)
- [Declaration of conformity](#)
- [Safety statements](#)

## FCC compliance

This equipment has been tested and found to comply with the limits for a Class B digital device, pursuant to Part 15 of the FCC rules. These limits are designed to provide reasonable protection against harmful interference in a residential installation. This equipment generates, uses, and can radiate radio frequency energy. If it is not installed and used in accordance with the instructions, it may cause harmful interference to radio communications. However, there is no guarantee that interference will not occur in a particular installation. If this equipment does cause harmful interference to radio or television reception, which can be determined by turning the equipment off and on, the user is encouraged to try to correct the interference by one or more of the following measures:

- Reorient or relocate the receiving antenna.
- Increase separation between equipment and receiver.
- Connect equipment to an outlet on a circuit different from that to which the receiver is located.
- Consult your dealer or an experienced radio/TV technician.

 **NOTE:** Any changes or modifications to the printer that are not expressly approved by Hewlett-Packard could void the user's authority to operate this equipment.

Use of a shielded interface cable is required to comply with the Class B limits of Part 15 of FCC rules.

This equipment complies with FCC rules, Part 68. On the back of this equipment is a label that contains, among other information, the FCC registration number and ringer equivalence number (REN) for this equipment. If requested, this information must be provided to the telephone company. The REN is used to determine the quantity of devices which may be connected to the telephone line. Excessive RENs on the telephone line may result in the devices not ringing in response to an incoming call. In most, but not all, areas, the sum of the RENs should not exceed five (5.0). To be certain of the number of devices that may be connected to the line, as determined by the total RENs, contact the telephone company to determine the maximum REN for the calling area.

This equipment uses the following USOC jacks: RJ11C.

An FCC-compliant telephone cord and modular plug is provided with this equipment. This equipment is designed to be connected to the telephone network or premises wiring using a compatible modular jack which is Part 68 compliant. This equipment cannot be used on telephone company-provided coin service. Connection to Party Line Service is subject to state tariffs. If this equipment causes harm to the telephone network, the telephone company will notify you in advance that temporary discontinuance of service may be required. If advance notice is not practical, the telephone company will notify the customer as soon as possible. Also, you will be advised of your right to file a complaint with the FCC if you believe it is necessary. The telephone company may make changes in its facilities, equipment, operations, or procedures that could affect the operation of the equipment. If this happens, the telephone company will provide advance notice in order for you to make the necessary modifications in order to maintain uninterrupted service. If trouble is experienced with this equipment, please see the numbers in the front of this manual for repair and (or) warranty information. If the trouble is causing harm to the telephone network, the telephone company may request you remove the equipment from the network until the problem is resolved. The following repairs can be done by the customer: Replace any original equipment that came with the device. This includes the print cartridge, the supports for trays and bins, the power cord, and the telephone cord. It is recommended that the customer install an AC surge arrester in the AC outlet to which this device is connected. This is to avoid damage to the equipment caused by local lightning strikes and other electrical surges.



# Environmental product stewardship program

## Protecting the environment

Hewlett-Packard Company is committed to providing quality products in an environmentally sound manner. This product has been designed with several attributes to minimize impacts on our environment.

## Ozone production

This product generates no appreciable ozone gas (O<sub>3</sub>).

## Power consumption

Power usage drops significantly while in Ready/Sleep mode, which saves natural resources and saves money without affecting the high performance of this product. To determine the ENERGY STAR® qualification status for this product see the Product Data Sheet or Specifications Sheet. Qualified products are also listed at:

<http://www.hp.com/hpinfo/globalcitizenship/environment/productdesign/ecolabels.html>

## Toner consumption

EconoMode uses less toner, which might extend the life of the print cartridge.

## Paper use

This device's manual/automatic duplex feature (two-sided printing) and N-up printing (multiple pages printed on one page) capability can reduce paper usage and the resulting demands on natural resources.

## Plastics

Plastic parts over 25 grams are marked according to international standards that enhance the ability to identify plastics for recycling purposes at the end of the product's life.

## HP LaserJet print supplies

It's easy to return and recycle your empty HP LaserJet print cartridges—free of charge—with HP Planet Partners. Multilingual program information and instructions are included in every new HP LaserJet print cartridge and supplies package. You help reduce the toll on the environment further when you return multiple cartridges together rather than separately.

HP is committed to providing inventive, high-quality products and services that are environmentally sound, from product design and manufacturing to distribution, customer use and recycling. When you participate in the HP Planet Partners program, we ensure your HP LaserJet print cartridges are recycled properly, processing them to recover plastics and metals for new products and diverting millions of tons of waste from landfills. Since this cartridge is being recycled and used in new materials, it will not be returned to you. Thank you for being environmentally responsible!

 **NOTE:** Use the return label to return original HP LaserJet print cartridges only. Please do not use this label for HP inkjet cartridges, non-HP cartridges, refilled or remanufactured cartridges or warranty returns. For information about recycling your HP inkjet cartridges please go to <http://www.hp.com/recycle>.

## Return and recycling instructions

### United States and Puerto Rico

The enclosed label in the HP LaserJet toner cartridge box is for the return and recycling of one or more HP LaserJet print cartridges after use. Please follow the applicable instructions below.

#### Multiple returns (two to eight cartridges)

1. Package each HP LaserJet print cartridge in its original box and bag.
2. Tape up to eight single boxes together using strapping or packaging tape (up to 70 lbs).
3. Use a single pre-paid shipping label.

#### OR

1. Use your own suitable box, or request a free bulk collection box from the <http://www.hp.com/recycle> or 1-800-340-2445 (holds up to eight HP LaserJet print cartridges).
2. Use a single pre-paid shipping label.

#### Single returns

1. Package the HP LaserJet print cartridge in its original bag and box.
2. Place the shipping label on the front of the box.

#### Shipping

For all HP LaserJet print cartridge recycling returns, give the package to UPS during your next delivery or pickup, or take it to an authorized UPS drop-off center. For the location of your local UPS drop-off center, call 1-800-PICKUPS or visit <http://www.ups.com>. If you are returning via USPS label, give the package to a U.S. Postal Service carrier or drop off at a U.S. Postal Service Office. For more information, or to order additional labels or boxes for bulk returns, visit <http://www.hp.com/recycle> or call 1-800-340-2445. Requested UPS pickup will be charged normal pickup rates. Information subject to change without notice.

#### Non-US returns

To participate in HP Planet Partners return and recycling program, just follow the simple directions in the recycling guide (found inside the packaging of your new printer supply item) or visit <http://www.hp.com/recycle>. Select your country/region for information on how to return your HP LaserJet printing supplies.

#### Paper

This product is capable of using recycled papers when the paper meets the guidelines outlined in the *HP LaserJet Printer Family Print Media Guide*. This product is suitable for the use of recycled paper according to EN12281:2002.

#### Material restrictions

This HP product does not contain added mercury.

This HP product contains a battery that might require special handling at end-of-life. The batteries contained in or supplied by Hewlett-Packard for this product include the following:

HP LaserJet M2727	
Type	Carbon monofluoride lithium
Weight	0.8 g
Location	On formatter board
User-removable	No



## 廢電池請回收

For recycling information, you can go to [www.hp.com/recycle](http://www.hp.com/recycle), or contact your local authorities or the Electronics Industries Alliance: [www.eiae.org](http://www.eiae.org).

## Disposal of waste equipment by users in private households in the European Union

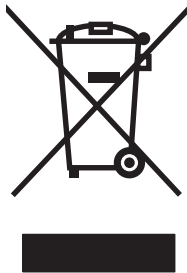

This symbol on the product or on its packaging indicates that this product must not be disposed of with your other household waste. Instead, it is your responsibility to dispose of your waste equipment by handing it over to a designated collection point for the recycling of waste electrical and electronic equipment. The separate collection and recycling of your waste equipment at the time of disposal will help to conserve natural resources and ensure that it is recycled in a manner that protects human health and the environment. For more information about where you can drop off your waste equipment for recycling, please contact your local city office, your household waste disposal service or the shop where you purchased the product.

## Material Safety Data Sheet (MSDS)

Material Safety Data Sheets (MSDS) for supplies containing chemical substances (for example, toner) can be obtained by contacting the HP Web site at [www.hp.com/go/msds](http://www.hp.com/go/msds) or [www.hp.com/hpinfo/globalcitizenship/environment](http://www.hp.com/hpinfo/globalcitizenship/environment).

## For more information

To obtain information about these environmental topics:

- Product environmental profile sheet for this and many related HP products
- HP's commitment to the environment
- HP's environmental management system
- HP's end-of-life product return and recycling program
- Material Safety Data Sheets

Visit [www.hp.com/go/environment](http://www.hp.com/go/environment) or [www.hp.com/hpinfo/globalcitizenship/environment/index.html](http://www.hp.com/hpinfo/globalcitizenship/environment/index.html).

## Telephone Consumer Protection Act (United States)

The Telephone Consumer Protection Act of 1991 makes it unlawful for any person to use a computer or other electronic device, including fax machines, to send any message unless such message clearly contains, in a margin at the top or bottom of each transmitted page or on the first page of the transmission, the date and time it is sent and an identification of the business, other entity, or individual sending the message and the telephone number of the sending machine or such business, other entity, or individual. (The telephone number provided cannot be a 900 number or any other number for which charges exceed local or long-distance transmission charges.)

### IC CS-03 requirements

**Notice:** The Industry Canada label identifies certified equipment. This certification means the equipment meets certain telecommunications network protective, operational, and safety requirements as prescribed in the appropriate Terminal Equipment Technical Requirement document(s). The Department does not guarantee the equipment will operate to the user's satisfaction. Before installing this equipment, users should ensure that it is permissible for the equipment to be connected to the facilities of the local telecommunications company. The equipment must also be installed using an acceptable method of connection. The customer should be aware that compliance with the above conditions may not prevent degradation of service in some situations. Repairs to certified equipment should be coordinated by a representative designated by the supplier. Any repairs or alterations made by the user to this equipment, or equipment malfunctions, may give the telecommunications company cause to request the user to disconnect the equipment. Users should ensure for their own protection that the electrical ground connections of the power utility, telephone lines, and internal metallic water pipe system, if present, are connected together. This precaution can be particularly important in rural areas.

---

△ **CAUTION:** Users should not attempt to make such connections themselves, but should contact the appropriate electric inspection authority, or electrician, as appropriate. The Ringer Equivalence Number (REN) of this device is 0.7.

---

**Notice:** The Ringer Equivalence Number (REN) assigned to each terminal device provides an indication of the maximum number of terminals allowed to be connected to a telephone interface. The termination on an interface may consist of any combination of devices subject only to the requirement that the sum of the Ringer Equivalence Number of all the devices does not exceed five (5.0). The standard connecting arrangement code (telephone jack type) for equipment with direct connections to the telephone network is CA11A.

## EU statement for telecom operation

This product is intended to be connected to the analog Public Switched Telecommunication Networks (PSTN) of European Economic Area (EEA) countries/regions. It meets requirements of EU R&TTE Directive 1999/5/EC (Annex II) and carries appropriate CE conformity marking. For more details, see Declaration of Conformity issued by the manufacturer in another section of this manual. However, due to differences between individual national PSTNs, the product may not guarantee unconditional assurance of successful operation on every PSTN termination point. Network compatibility depends on the correct setting being selected by the customer in preparation of its connection to the PSTN. Please follow the instructions provided in the user manual. If you experience network compatibility issues, please contact your equipment supplier or Hewlett-Packard help desk in the country/region of operation. Connecting to a PSTN termination point may be the subject of additional requirements set out by the local PSTN operator.

## New Zealand telecom statements

The grant of a Telepermit for any item of terminal equipment indicates only that Telecom has accepted that the item complies with minimum conditions for connection to its network. It indicates no endorsement of the product by Telecom, nor does it provide any sort of warranty. Above all, it provides no assurance that any item will work correctly in all respects with another item of Telepermitted equipment of a different make or model, nor does it imply that any product is compatible with all of Telecom's network services.

This equipment may not provide for the effective hand-over of a call to another device connected to the same line.

This equipment shall not be set up to make automatic calls to the Telecom "111" Emergency Service.

This product has not been tested to ensure compatibility with the FaxAbility distinctive ring service for New Zealand.

# Declaration of conformity

## Declaration of Conformity

according to ISO/IEC 17050-1 and EN 17050-1

**Manufacturer's Name:** Hewlett-Packard Company DoC#: BOISB-0602-01-rel.1.0  
**Manufacturer's Address:** 11311 Chinden Boulevard,  
Boise, Idaho 83714-1021, USA

**declares, that the product**

**Product Name:** HP LaserJet M2727 nf and M2727nfs  
**Regulatory Model Number<sup>2)</sup>** BOISB-0602-01

**Product Options:** Including: Q7556A—Optional 250-Sheet Input Tray  
**Print Cartridges:** ALL  
Q7553A / Q7553X

**conforms to the following Product Specifications:**

**SAFETY:** IEC 60950-1:2001 / EN60950-1: 2001 +A11  
IEC 60825-1:1993 +A1 +A2 / EN 60825-1:1994 +A1 +A2 (Class 1 Laser/LED Product)  
GB4943-2001

**EMC:** CISPR22:2005 / EN55022:2006 – Class B<sup>1)</sup>  
EN 61000-3-2:2000 +A2  
EN 61000-3-3:1995 +A1  
EN 55024:1998 +A1 +A2  
FCC Title 47 CFR, Part 15 Class B<sup>1)</sup> / ICES-003, Issue 4  
GB9254-1998, GB17625.1-2003

**TELECOM:** ES 203 021; FCC Title 47 CFR, Part 68<sup>3)</sup>

### Supplementary Information:

The product herewith complies with the requirements of the EMC Directive 2004/108/EC and the Low Voltage Directive 2006/95/EC, the R&TTE Directive 1999/5/EC (Annex II), and carries the CE-Marking accordingly.

This Device complies with Part 15 of the FCC Rules. Operation is subject to the following two Conditions: (1) this device may not cause harmful interference, and (2) this device must accept any interference received, including interference that may cause undesired operation.

- 1) The product was tested in a typical configuration with Hewlett-Packard Personal Computer Systems.
- 2) For regulatory purposes, this product is assigned a Regulatory model number. This number should not be confused with the product name or the product number(s).
- 3) Telecom approvals and standards appropriate for the target countries/regions have been applied to this product, in addition to those listed above.

Boise, Idaho , USA

**July 2007**

### For regulatory topics only:

**European Contact:** Your Local Hewlett-Packard Sales and Service Office or Hewlett-Packard GmbH, Department HQ-TRE / Standards Europe,, Herrenberger Strasse 140, , D-71034, Böblingen, (FAX: +49-7031-14-3143)

**USA Contact:** Product Regulations Manager, Hewlett-Packard Company,, PO Box 15, Mail Stop 160, Boise, ID 83707-0015, , (Phone: 208-396-6000)

## Safety statements

### Laser safety

The Center for Devices and Radiological Health (CDRH) of the U.S. Food and Drug Administration has implemented regulations for laser products manufactured since August 1, 1976. Compliance is mandatory for products marketed in the United States. The device is certified as a “Class 1” laser product under the U.S. Department of Health and Human Services (DHHS) Radiation Performance Standard according to the Radiation Control for Health and Safety Act of 1968. Since radiation emitted inside the device is completely confined within protective housings and external covers, the laser beam cannot escape during any phase of normal user operation.

**⚠ WARNING!** Using controls, making adjustments, or performing procedures other than those specified in this user guide may result in exposure to hazardous radiation.

### Canadian DOC regulations

Complies with Canadian EMC Class B requirements.

« Conforme à la classe B des normes canadiennes de compatibilité électromagnétiques. « CEM ». »

### EMI statement (Korea)

**B급 기기 (가정용 정보통신기기)**

이 기기는 가정용으로 전자파적합등록을 한 기기로서  
주거지역에서는 물론 모든지역에서 사용할 수 있습니다.



## Laser statement for Finland

### Luokan 1 laserlaite

Klass 1 Laser Apparat

HP LaserJet M2727nf, M2727nfs, laserkirjoitin on käyttäjän kannalta turvallinen luokan 1 laserlaite. Normaalisissa käytössä kirjoittimen suojakotelointi estää lasersäteen pääsyn laitteen ulkopuolelle. Laitteen turvallisuusluokka on määritetty standardin EN 60825-1 (1994) mukaisesti.

### VAROITUS !

Laitteen käyttäminen muulla kuin käyttöohjeessa mainitulla tavalla saattaa altistaa käyttäjän turvallisuusluokan 1 ylittävälle näkymättömälle lasersäteilylle.

### VARNING !

Om apparaten används på annat sätt än i bruksanvisning specificerats, kan användaren utsättas för osynlig laserstrålning, som överskrider gränsen för laserklass 1.

### HUOLTO

HP LaserJet M2727nf, M2727nfs - kirjoittimen sisällä ei ole käyttäjän huollettavissa olevia kohteita. Laitteen saa avata ja huoltaa ainoastaan sen huoltamiseen koulutettu henkilö. Tällaiseksi huoltotoimenpiteeksi ei katsota väriainekasetin vaihtamista, paperiradan puhdistusta tai muita käyttäjän käsikirjassa lueteltuja, käyttäjän tehtäväksi tarkoitettuja ylläpitotoimia, jotka voidaan suorittaa ilman erikoistyökaluja.

### VARO !

Mikäli kirjoittimen suojakotelo avataan, olet alttiina näkymättömälle lasersäteilylle laitteen ollessa toiminnassa. Älä katso säteeseen.

### VARNING !

Om laserprinterns skyddshölje öppnas då apparaten är i funktion, utsättas användaren för osynlig laserstrålning. Betrakta ej strålen. Tiedot laitteessa käytettävän laserdiodin säteilyominaisuuksista: Aallonpituus 775-795 nm Teho 5 m W Luokan 3B laser.

## Substances table (China)

根据中国电子信息产品污染控制管理办法的要求而出台

Table D-1 有毒有害物质表

部件名称	有毒有害物质和元素					
	铅 (Pb)	汞 (Hg)	镉 (Cd)	六价铬 (Cr(VI))	多溴联苯 (PBB)	多溴二苯醚 (PBDE)
打印引擎	X	○	X	X	○	○
复印机组件	X	○	○	○	○	○
控制面板	○	○	○	○	○	○
塑料外壳	○	○	○	○	○	○
格式化板组件	X	○	○	○	○	○
碳粉盒	X	○	○	○	○	○

**O:**表示在此部件所用的所有同类材料中，所含的此有毒或有害物质均低于 SJ/T11363-2006 的限制要求。

**X:**表示在此部件所用的所有同类材料中，至少一种所含的此有毒或有害物质高于 SJ/T11363-2006 的限制要求。

---

 **NOTE:** 引用的“环保使用期限”是根据在正常温度和湿度条件下操作使用产品而确定的。

---

---

# Glossary

**ADF** Automatic document feeder. The ADF is used to automatically feed originals into the product for copying, scanning, or faxing.

**browser** Short for Web browser, a software program that is used to locate and open Web pages.

**collate** The process of printing a multiple-copy job in sets. When collate is selected, the product prints an entire set before printing additional copies. Otherwise, the product prints the specified number of copies of one page before printing the subsequent pages.

**comma (,)** A comma in a fax dial sequence indicates that the product will pause at that point in the dialing sequence.

**contrast** The difference between the dark and light areas of an image. The lower the number value, the more closely the shades resemble each other. The higher the number, the more the shades appear separate from each other.

**dedicated line** A single telephone line that is used exclusively for either voice calls or fax calls.

**DIMM** Dual inline memory module, a small circuit board that holds memory. A single in-line memory module (SIMM) has a 32-bit path to the memory, whereas a DIMM has a 64-bit path.

**distinctive ring** A service offered by some telephone companies in some countries/regions that allows two or three phone numbers to be set up on the same telephone line. Each phone number has a different ring pattern, and the fax machine can be configured to recognize the distinctive ring of the fax number.

**dots per inch (dpi)** A measurement of resolution that is used for printing. Generally, more dots per inch result in a higher resolution, more visible detail in the image, and a larger file size.

**DSL** Digital subscriber line, a technology that enables a high-speed, direct connection to the Internet through telephone lines.

**e-mail (electronic mail)** An abbreviation for electronic mail. Software that can be used to electronically transmit items over a communications network.

**fax** An abbreviation of facsimile. The electronic encoding of a printed page and the transmission of the electronic page over a telephone line. The product software can send items to electronic fax programs, which require a modem and fax software.

**fax functions** Fax-related tasks that are done from the control panel or software that affect only the current job, or are done only once before returning to the Ready state, such as clearing memory. These functions are in their own section in the control-panel menu.

**fax settings** Fax-related items that, when set or changed, continue to use the choice made until changed again. An example would be the number of times set for the product to redial a busy number. These settings are in their own section of the control panel menu.

**file format** The way the contents of a file are structured by a program or group of programs.

**grayscale** Shades of gray that represent light and dark portions of an image when color images are converted to grayscale; colors are represented by various shades of gray.

**halftone** An image type that simulates grayscale by varying the number of dots. Highly colored areas consist of a large number of dots, while lighter areas consist of a smaller number of dots.

**HP Director** A software screen that is used when working with documents. When the document is loaded into the automatic document feeder (ADF) and the computer is connected directly to the product, the HP Director appears on the computer screen to initiate faxing, copying, or scanning.

**HP ToolboxFX** HP ToolboxFX is a program that provides access to the product management and troubleshooting tools, embedded Web server, and product documentation. HP ToolboxFX does not support Macintosh operating systems.

**ISDN** Integrated Services Digital Network (ISDN) is a suite of internationally adopted standards for end-to-end digital communication over the public telephone network.

**link** A connection to a program or device that can be used to send information from the product software to other programs, such as e-mail, electronic fax, and OCR links.

**optical character recognition (OCR) software** OCR software converts an electronic image of text, such as a scanned document, into a form that word processor, spreadsheet, and database programs can use.

**pixels per inch (ppi)** A measurement of resolution that is used for scanning. Generally, more pixels per inch result in a higher resolution, more visible detail in the image, and a larger file size.

**printer driver** A printer driver is a program that software programs use to gain access to a product's features. A printer driver translates a software program's formatting commands (such as page breaks and font selection) into a printer language (such as PostScript or PCL), and then sends the print file to the product.

**private branch exchange (PBX)** A small telephone switching system that typically is used by large businesses or universities to connect all telephone extensions within the organization. A PBX also connects to the public switched telephone network (PSTN) and may be either manual or dial, depending on the method used by extensions to place incoming or outgoing calls. Normally, the equipment is owned by the customer rather than leased from the telephone company.

**public switched telephone network (PSTN)** The worldwide dial-up telephone network or a portion of that network. Users are assigned unique phone numbers, which allow them to connect to the PSTN through local telephone exchange companies. Often, this phrase is used when referring to data or other non-telephone services carried over a path initially established using normal telephone signaling and ordinary switched long-distance telephone circuits.

**Readiris** An optical character recognition (OCR) program that was developed by I.R.I.S. and that is included with the product software.

**resolution** The sharpness of an image, measured in dots per inch (dpi). The higher the dpi, the greater the resolution.

**shared line** A single telephone line that is used for both voice and fax calls.

**surge protector** A device that protects a power supply and communications lines from electrical surges.

**TWAIN** An industry standard for scanners and software. By using a TWAIN-compliant scanner with a TWAIN-compliant program, a scan can be initiated from within the program.

**URL** Uniform resource locator, the global address of documents and resources on the Internet. The first part of the address indicates what protocol to use, the second part specifies the IP address or the domain name where the resource is located.

**USB** Universal serial bus (USB) is a standard that was developed by the USB Implementers Forum, Inc., to connect computers and peripherals. USB is designed to concurrently connect a single computer USB port to multiple peripherals.

**watermarks** A watermark adds background text to a document that is being printed. For example, "Confidential" can be printed in the background text of a document to indicate that the document is confidential. A selection can be made from a set of predefined watermarks, and the font, size, angle, and style can be changed. The product can place the watermark on the first page only or all pages.

**WIA** Windows Imaging Architecture (WIA) is an imaging architecture that is available in Windows Me and Windows XP. A scan can be initiated from within these operating systems by using a WIA-compliant scanner.



---

# Index

## A

accessibility features 3  
accessories  
    part numbers 214  
acoustic emissions 225  
activity log, fax  
    troubleshooting 140  
ad hoc groups, sending faxes  
    to 121  
add  
    scan destinations  
        (Windows) 85  
ADF  
    jams 177  
    locating 4  
    page sizes supported 136  
    part number 215  
alert messages 170  
alerts, setting up 144  
answer mode, setting 111  
answering machines, connecting  
    fax settings 110  
authorized dealers 220  
automatic document feeder  
    loading for scanning 82  
automatic document feeder (ADF)  
    capacity 68  
    jams 177  
    load for copying 68  
    locating 4  
    page sizes supported 136  
    part number 215  
autoreduction settings, fax 113

## B

background shading,  
    troubleshooting 191  
bands and streaks,  
    troubleshooting 191  
batteries included 230

billing codes, fax  
    using 109  
bins, output  
    jams, clearing 185  
    locating 4  
black and white scanning 88  
blank copies,  
    troubleshooting 200  
blank pages  
    printing 59  
    troubleshooting 196  
blank scans, troubleshooting 203  
blocking faxes 114  
booklet settings  
    Windows 57  
books  
    copying 76  
    scanning 90  
busy signals, redialing  
    options 106

## C

cables  
    part numbers 214  
    USB, troubleshooting 197  
call report, fax  
    troubleshooting 140  
caller-ID boxes, connecting 96  
calling cards 120  
Canadian DOC regulations 236  
canceling  
    copy jobs 70  
    faxes 116  
    print job 56  
    scan jobs 86  
cartridge-door release, locating 4  
cartridges  
    HP fraud hotline 158  
    part numbers 214  
    recycling 158, 229  
    replacing 159  
    reusing 159  
    status, checking 157  
    status, viewing with  
        HP ToolboxFX 144  
    storing 158  
    warranty 219  
cartridges, print  
    Macintosh status 34  
characters, troubleshooting 192  
cleaning  
    automatic document  
        feeder 163  
    exterior 165  
    glass 88, 165  
    lid backing 164  
    paper path 162  
    scanner glass 72  
    scanner strip 73, 164  
collating copies 71  
color  
    scanning settings 88  
color, scanning settings 87  
comparison, product models 1  
configuration page  
    printing 142  
contacting HP 220  
contrast settings  
    copy 73  
    fax 107  
control panel  
    cleaning page, printing 162  
    HP ToolboxFX system  
        settings 151  
    menus 11  
    messages,  
        troubleshooting 170  
    scanning from (Macintosh) 35

- settings 23, 28
- supplies status, checking
  - from 157
- control-panel
  - troubleshooting display problems 176
- convenience stapler
  - jams, clearing 188
  - specifications 3
  - supplies, part numbers 214
- copying
  - books 76
  - canceling 70
  - changing default number 69
  - collating 71
  - contrast, adjusting 73
  - double-sided 78
  - draft setting 74
  - edge-to-edge 74
  - enlarging 70
  - light/dark settings 73
  - loading ADF 68
  - loading flatbed scanner 68
  - media settings 74
  - media sizes 74
  - media types 74
  - media, troubleshooting 199
  - mixed-size originals 78
  - multiple copies 69
  - one-sided to two-sided 78
  - one-touch 69
  - photos 76
  - quality, adjusting 72
  - quality, troubleshooting 198
  - reducing 70
  - restore default settings 76
  - setup menu 12
  - size, troubleshooting 200
  - tray selection 51
  - troubleshooting 200
  - two-sided setting,
    - changing 79
  - two-sided to two-sided 78
  - two-sided, manually 79
- cover pages 32, 59
- creases, troubleshooting 193
- crooked pages 193, 195
- curled media 193
- custom-size copies 70
- custom-size paper settings
  - Macintosh 32
- customer support
  - online 220
  - repacking device 221
- D**
- dark copying 198
- darkness, contrast settings
  - copy 73
  - fax 107
- defaults, restoring 169
- delaying fax sending 126
- deleting faxes from memory 117
- demo page, printing 142
- density, print
  - changing settings 57
- destinations, add scan
  - Windows 85
- device discovery over
  - network“ 39
- device polling 151
- device status
  - Macintosh Services tab 34
- dial-tone detection settings 106
- dialing
  - fax 15
  - from a telephone 126
  - manually 120
  - pauses, inserting 100
  - prefixes, inserting 105
  - redial manually 122
  - redialing automatically,
    - settings 106
  - tone or pulse settings 108
  - troubleshooting 137
- dimensions
  - media 47
- DIMMs
  - adding 160
  - part numbers 214
- disposal, end-of-life 230
- distinctive-ring settings 112
- Documentation tab,
  - HP ToolboxFX 148
- dots per inch (dpi)
  - fax 107, 108
  - specifications 3
- dots, troubleshooting 190
- double-sided copying 78
- double-sided printing
  - automatic, Windows 63
  - manual, Windows 63
- dpi (dots per inch)
  - fax 107, 108
  - faxing 15
  - scanning 87
  - specifications 3
- drivers
  - Macintosh settings 32
  - Macintosh,
    - troubleshooting 208
  - operating systems
    - supported 7
  - presets (Macintosh) 32
  - settings 23, 28
  - shortcuts (Windows) 62
  - specifications 3
  - supported 22
  - Windows settings 62
- duplex printing
  - automatic, Windows 63
  - manual, Windows 63
- duplexer
  - jams, clearing 183
- E**
- e-mail
  - setting alerts in
    - HP ToolboxFX 145
- e-mail alerts, setting up 144
- e-mail, scanning to
  - Macintosh 35
  - resolution settings 88
  - Windows 86
- EconoMode setting 61
- edge-to-edge printing 74
- electrical specifications 224
- electronic faxes
  - receiving 112
  - sending 124
- embedded Web server 25, 30
- embedded Web server (EWS)
  - features 153
- end-of-life disposal 230
- enlarging documents
  - copying 70
- environmental specifications 225
- environmental stewardship
  - program 229



- EPS files, troubleshooting 209
- error messages
  - control panel 170
  - critical 174
- error messages, fax 129
- error report, fax
  - printing 134
- error-correction setting, fax 135
- errors, PostScript 210
- EU statement for telecom operation 234
- European Union, waste disposal 231
- event log 144
- express software installation 7
- extended warranty 222
- extension phones
  - receiving faxes from 115
  - sending faxes from 126
- F**
- factory-set defaults, restoring 169
- faded print 190
- fax
  - ad hoc groups 121
  - answer mode 16, 111
  - autoreduction 113
  - billing codes 109
  - blocking 114
  - canceling 116
  - contrast setting 107
  - delaying sending 126
  - deleting from memory 117
  - detect-dial-tone settings 106
  - dial prefixes 105
  - dialing, tone or pulse 108
  - error messages 129
  - error report, printing 134
  - error-correction 135
  - extension phone
    - receiving 115
  - factory-set defaults, restoring 169
  - forwarding 111
  - glass-size setting 108
  - group-dial entries 123
  - jams, troubleshooting 176
  - manual dialing 120
  - pauses, inserting 100
  - polling 103
  - receive log 148
  - receiving from software 112
  - receiving when you hear fax tones 128
  - redial manually 122
  - redial settings 106
  - reports 13
  - reports, printing all 133
  - reports, troubleshooting 140
  - reprinting from memory 127
  - resolution 107, 108
  - ring patterns 112
  - ring type 16
  - rings-to-answer 110
  - security, password protection 103
  - security, private receive 104
  - send by using speed dial 122
  - send log 148
  - sending from a telephone 126
  - sending from software 124
  - silence-detect mode 113
  - speed dials 122
  - stamp-received 114
  - troubleshooting receiving 138
  - troubleshooting sending 136
  - V.34 setting 135
  - volume settings 105
- fax date, setup
  - use control panel 97
  - use HP Fax Setup Wizard 98
- fax header, setup
  - use control panel 97
  - use HP Fax Setup Wizard 98
- fax ports, locating 5
- fax reports, printing 13
- Fax tab, HP ToolboxFX 145
- fax time, setup
  - use control panel 97
  - use HP Fax Setup Wizard 98
- faxing
  - from a computer (Macintosh) 36
- FCC compliance 228
- features
  - product 3
- feeding problems, troubleshooting 195
- file, scanning to Macintosh 35
- Finnish laser safety statement 237
- firmware updates 165
- first page
  - blank 59
  - use different paper 32, 59
- Fit to Page setting, fax 113
- flatbed scanner
  - default glass-size, setting 108
- folder, scanning to 86
- fonts
  - printing font lists 142
  - selecting 65
- forwarding faxes 111
- fraud hotline 158
- fuser
  - error 174
  - media guidelines 58
  - warranty 219
- G**
- General Protection FaultException OE 208
- glass, cleaning 88, 165
- glass-size setting 108
- glossary of terms 239
- gray background, troubleshooting 191
- grayscale scanning 88
- group-dial entries
  - creating 102
  - deleting 102
  - editing 102
  - sending faxes to 123
- H**
- Help tab, HP ToolboxFX 148
- HP Customer Care 220
- HP fraud hotline 158
- HP Instant Support Professional Edition (ISPE) 220
- HP LaserJet Scan (Windows) 83
- HP SupportPack 222
- HP ToolboxFX
  - device information 149
  - Documentation tab 148
  - Fax tab 145
  - Help tab 148
  - Network Settings tab 152
  - opening 144

- Print Settings tab 151
- Status tab 144
- supplies status, checking
  - from 157
- System Settings tab 149
- HP Web Jetadmin 25, 154
- HP-Authorized Dealers 220
- HP-UX software 26
- humidity specifications
  - environment 225

**I**

- IC CS-03 requirements 233
- Illegal Operation errors 208
- image quality
  - copy, troubleshooting 198
  - HP ToolboxFX settings 150
  - print, troubleshooting 190, 204
  - scans, troubleshooting 201, 203
- information pages
  - configuration 41
  - network configuration 41
- input tray
  - loading media 50
- installation, software
  - express 7
  - recommended 6
  - types (Windows) 24
- installing
  - Macintosh software for direct connections 29
  - Macintosh software on networks 29
  - Windows software 6, 24
- Instant Support Professional Edition (ISPE) 220
- interface ports
  - cables, ordering 214
  - locating 5
  - types included 3
- international dialing 120
- IP address
  - automatic configuration 42
  - Macintosh, troubleshooting 208
  - manual configuration 42
  - protocols supported 39

**J**

- jams
  - ADF, clearing 177
  - causes of 176
  - duplexer, clearing 183
  - fax, clearing 177
  - locating 177
  - output-bin, clearing 185
  - preventing 189
  - print cartridge area, clearing 187
  - stapler, clearing 188
  - trays, clearing 180
- Jetadmin, HP Web 25, 154

**K**

- Korean EMI statement 236

**L**

- landscape orientation, setting 61
- laser safety statements 236, 237
- LaserJet Scan (Windows) 83
- lid, cleaning 164
- light copying 198
- light print, troubleshooting 190
- lightness
  - copy contrast 73
  - faded print, troubleshooting 190
  - fax contrast 107
- lines, troubleshooting
  - copies 198
  - printed pages 191
  - scans 203
- link speed settings 42
- Linux 26
- Linux drivers 7
- Linux software 26
- loading
  - staples 156
- loading media
  - optional tray 3 50
  - tray 1 49
  - tray 2 50
- logs, fax
  - error 134
  - printing all 133
  - troubleshooting 140
- loose toner, troubleshooting 192

**M**

- Macintosh
  - Configure Device 30
  - driver settings 28, 32
  - drivers supported 7
  - drivers, troubleshooting 208
  - faxing 36
  - faxing from 124
  - installing printing system for direct connections 29
  - installing printing system for networks 29
  - Intel Core Processor 6
  - PPC 6
  - print settings 28
  - problems, solving 208
  - removing software 30
  - resize documents 32
  - scanning from control panel 35
  - scanning from TWAIN-compliant software 84
  - scanning page-by-page 35
  - scanning to e-mail 35
  - scanning to file 35
  - support 221
  - supported operating systems 6, 28
  - USB card, troubleshooting 209
- Macintosh Configure Device 30
- Macintosh driver settings
  - custom-size paper 32
  - Services tab 34
  - watermarks 33
- maintenance agreements 221
- manual dialing 120
- manual redial 122
- material restrictions 230
- Material Safety Data Sheet (MSDS) 231
- media
  - ADF, sizes supported 136
  - copy settings 74
  - curled, troubleshooting 193
  - custom-size, Macintosh settings 32
  - default size for tray 51
  - document size, selecting 60
  - fax autoreduction settings 113

- first page 32, 59
- HP ToolboxFX settings 150
- jams 176
- orientation, setting 61
- pages per sheet 33
- pages per sheet, Windows 64
- printing on special media 58
- select size and type 54
- size, changing 75
- size, selecting 60
- source, selecting 60
- stapling 155, 156
- supported sizes 47
- troubleshooting 194
- type, changing 75
- type, selecting 60
- wrinkled 193
- memory
  - deleting faxes 117
  - error messages 172
  - installing 160
  - part numbers 214
  - reprinting faxes 127
- menu
  - control panel, access 11
  - Copy setup 12
  - Fax functions 11
  - Fax Job status 11
  - Fax setup 14
  - Network config 19
  - Reports 13
  - Service 19
  - System setup 17
- menu map
  - printing 143
- mercury-free product 230
- messages
  - control panel 170
  - critical 174
- Microsoft Word, faxing from 125
- model
  - comparison 1
  - number, locating 5
- modems, connecting 96
- multiple pages per sheet 33, 64
- N**
- n-up printing
  - Windows 64
- network
  - configuring 19, 37
  - device polling 151
  - IP address configuration 42
  - link speed settings 42
  - operating systems
    - supported 38
  - product discovery 39
  - protocols supported 39
  - troubleshooting 206
- Network config menu 19
- network configuration page 41
- network port
  - locating 5
  - setting up 40
- network report, printing 143
- Network Settings tab,
  - HP ToolboxFX 152
- networks
  - HP Web Jetadmin 154
  - Macintosh installation 29
- New Zealand telecom
  - statements 234
- next-day on-site service 221
- noise specifications 225
- number of copies, changing 69
- O**
- OCR software 85
- on-site service agreements 221
- on/off switch, locating 4
- online support 220
- operating environment,
  - specifications 225
- operating systems supported 6, 7, 22, 28
- operating systems, networks 38
- optical character recognition
  - software 85
- ordering supplies and
  - accessories 214
- orientation, setting 61
- output bins
  - locating 4
- output quality
  - copy, troubleshooting 198
  - HP ToolboxFX settings 150
- print, troubleshooting 190, 204
- scans, troubleshooting 201, 203
- outside lines
  - dial prefixes 105
  - pauses, inserting 100
- P**
- packaging device 221
- page-by-page scanning
  - (Macintosh) 35
- pages
  - blank 196
  - excessive curl 195
  - misfeeding 195
  - not printing 197
  - skewed 193, 195
- pages per sheet
  - Windows 64
- paper
  - ADF, sizes supported 136
  - copy settings 74
  - curled, troubleshooting 193
  - custom-size, Macintosh
    - settings 32
  - document size, selecting 60
  - fax autoreduction settings 113
  - first page 32, 59
  - HP ToolboxFX settings 150
  - jams 176
  - pages per sheet 33
  - size, changing 75
  - size, selecting 60
  - source, selecting 60
  - stapling 155
  - supported sizes 47
  - supported types 54
  - troubleshooting 194
  - type, changing 75
  - type, selecting 60
  - wrinkled 193
- paper input trays
  - feeding problems,
    - troubleshooting 195
- part numbers
  - cables 214
  - memory 214
  - supplies 214

- trays 214
  - user-replaceable parts 215
  - parts, user-replaceable 215
  - password protection 103
  - pauses, inserting 100
  - PCL drivers
    - operating systems supported 7
  - peer-to-peer printing
    - disclaimer 38
  - phone book, fax
    - adding entries 122
    - deleting all entries 100
    - HP ToolboxFX tab 146
    - importing 99
  - phone numbers
    - HP fraud hotline 158
  - phones
    - receiving faxes from 115, 128
  - phones, connecting extra 97
  - phones, downstream
    - sending faxes from 126
  - photos
    - copying 76
    - scanning 91
    - scanning, troubleshooting 201
  - physical specifications 224
  - pick-up rollers, ordering 215
  - pixels per inch (ppi), scanning
    - resolution 87
  - polling faxes 103
  - polling, device 151
  - portrait orientation, setting 61
  - ports
    - cables, ordering 214
    - locating 5
    - troubleshooting
      - Macintosh 209
    - types included 3
  - PostScript driver, HP ToolboxFX
    - settings 152
  - PostScript, errors 210
  - power
    - requirements 224
  - power consumption 224
  - power switch, locating 4
  - PPDs, Macintosh 208
  - ppi (pixels per inch), scanning
    - resolution 87
  - prefixes, dial 105
  - presets (Macintosh) 32
  - print cartridge area jams,
    - clearing 187
  - print cartridges
    - door release, locating 4
    - HP fraud hotline 158
    - Macintosh status 34
    - part numbers 214
    - recycling 158, 229
    - replacing 159
    - reusing 159
    - status, checking 157
    - status, viewing with
      - HP ToolboxFX 144
    - storing 158
    - warranty 219
  - print density
    - changing settings 57
  - print job
    - canceling 56
  - print media
    - supported 47
  - print quality
    - HP ToolboxFX settings 150
    - troubleshooting 190, 204
  - Print Settings tab,
    - HP ToolboxFX 151
  - printer drivers
    - Macintosh,
      - troubleshooting 208
    - specifications 3
  - printing
    - configuration page 142
    - connect to a network 40
    - demo page 142
    - direct connection to
      - computer 38
    - double-sided (duplex),
      - Macintosh 34
    - double-sided, Windows 63
    - edge-to-edge 74
    - font lists 142
    - Macintosh 32
    - menu map 143
    - network report 143
    - on different media size 60
    - shortcuts 62
    - supplies status page 142
    - troubleshooting 197
    - usage page 142
    - USB connection 38
  - priority, settings 23, 28
  - private receive 104
  - problem solving
    - Macintosh problems 208
    - PostScript errors 210
  - problem-solving
    - Windows issues 208
  - product
    - model comparison 1
    - serial number, locating 5
  - protocol settings, fax 135
  - protocols, networks 39
  - PS Emulation drivers 22
  - pulse-dialing 108
- Q**
- quality
    - copy settings 72
    - copy, troubleshooting 198
    - HP ToolboxFX settings 150
    - print settings (Macintosh) 32
    - print settings (Windows) 205
    - print, troubleshooting 190, 204
    - scans, troubleshooting 201, 203
- R**
- Readiris OCR software 85
  - receiving faxes
    - answer mode, setting 111
    - autoreduction settings 113
    - blocking 114
    - error report, printing 134
    - from extension phone 115
    - from software 112
    - log, HP ToolboxFX 148
    - polling 103
    - reprinting 127
    - ring patterns, settings 112
    - rings-to-answer settings 110
    - silence-detect mode 113
    - stamp-received setting 114
    - troubleshooting 138
    - when you hear fax tones 128
  - recommended software
    - installation 6

- recycling
  - HP printing supplies returns and environmental program 230
- recycling supplies 158
- redial
  - manually 122
- redialing
  - automatically, settings 106
- redistribute toner 159
- reducing documents
  - copying 70
- regulatory information 228
- removing Macintosh software 30
- removing software
  - Windows 24
- repacking device 221
- repetitive defects, troubleshooting 194
- replacing print cartridges 159
- reports
  - configuration page 13, 142
  - demo page 13, 142
  - fax 13
  - menu map 13, 143
  - network report 14, 143
  - PCL 6 font list 14
  - PCL font list 14
  - PS font list 14
  - service page 14
  - supplies status page 14, 142
  - usage page 14, 142
- reports, fax
  - error 134
  - printing all 133
  - troubleshooting 140
- reports, product
  - configuration page 41
  - network configuration page 41
- reprinting faxes 127
- resize documents
  - Macintosh 32
- resizing documents
  - copying 70
- resolution
  - fax 107, 108
  - scanning 87
  - specifications 3
- restoring factory-set defaults 169
- ring patterns 112
- ring tones
  - distinctive 112
- rings-to-answer setting 110
- rollers, ordering 215
- S**
- safety statements 236, 237
- scale documents
  - Macintosh 32
- scaling documents
  - copying 70
- Scan to button, setting up 85
- scanner
  - glass cleaning 88
  - glass, cleaning 72
  - load for copying 68
  - loading for scanning 82
  - strip, cleaning 73
- scanning
  - black and white 88
  - blank pages, troubleshooting 203
  - books 90
  - canceling 86
  - color 87
  - file formats 87
  - from control panel 84
  - from control panel (Macintosh) 35
  - from HP LaserJet Scan (Windows) 83
  - grayscale 88
  - loading ADF 82
  - loading flatbed scanner 82
  - methods 83
  - OCR software 85
  - page-by-page (Macintosh) 35
  - photos 91
  - quality, troubleshooting 201, 203
  - resolution 87
  - speed, troubleshooting 202
  - to e-mail (Macintosh) 35
  - to e-mail (Windows) 86
  - to file (Macintosh) 35
  - to file (Windows) 86
  - to folder (Windows) 86
  - to program (Windows) 86
  - TWAIN-compliant software 84
  - WIA-compliant software 84
- scatter, troubleshooting 194
- sending faxes
  - ad hoc groups 121
  - billing codes 109
  - canceling 116
  - delaying 126
  - error report, printing 134
  - forwarding 111
  - from downstream telephone 126
  - from software 124
  - group-dial entries 123
  - log, HP ToolboxFX 148
  - manual dialing 120
  - speed dial 122
  - troubleshooting 136
- separation pad, ordering 215
- serial number, locating 5
- service
  - critical error messages 174
  - HP ToolboxFX settings 151
  - HP-Authorized Dealers 220
  - part numbers 214
  - repacking device 221
- service agreements 221
- Service menu 19
- Services tab
  - Macintosh 34
- settings
  - configuration page 41
  - driver presets (Macintosh) 32
  - drivers 23, 28
  - factory-set defaults, restoring 169
  - HP ToolboxFX 149
  - network configuration page 41
  - network printing 40
  - priority 23, 28
  - shortcuts (Windows) 62
- shipping device 221
- shortcuts 62
- shortcuts, printing 62
- silence-detect mode 113
- size 224
- size, copy
  - reducing or enlarging 70
  - troubleshooting 200
- size, media
  - tray selection 54

- sizes, media
    - Fit to Page setting, faxing 113
  - skewed pages 193, 195
  - slow speed, troubleshooting
    - faxing 140
    - scanning 202
  - smeared toner,
    - troubleshooting 191
  - software
    - components 6
    - direct connection installation,
      - Macintosh 29
    - embedded Web server 25, 30
    - express installation 7
    - HP ToolboxFX 25, 144
    - HP Web Jetadmin 25
    - Linux 26
    - Macintosh Configure Device 30
    - network installation,
      - Macintosh 29
    - Readiris OCR 85
    - receiving faxes 112
    - recommended installation 6
    - scanning from TWAIN or WIA 84
    - sending faxes 124
    - settings 23, 28
    - Solaris 26
    - supported operating systems 6, 22, 28
    - uninstalling Macintosh 30
    - UNIX 26
    - Windows 25
    - Windows components 21
  - Solaris software 26
  - special media
    - guidelines 48
  - special paper
    - guidelines 48
  - specifications
    - acoustic emissions 225
    - electrical 224
    - environmental 225
    - physical 224
    - product features 3
  - specks, troubleshooting 190
  - speed
    - fax, troubleshooting 140
    - scanning, troubleshooting 202
  - speed dials
    - creating 101
    - deleting 101
    - deleting all 100
    - editing 101
    - programming 122
  - Spool32 errors 208
  - spots, troubleshooting 190
  - staple cassette
    - loading 156
    - specifications 3
  - staple cassette, part numbers 214
  - stapler
    - jams, clearing 188
    - loading staples 156
    - locating 4
    - supplies, part numbers 214
    - troubleshooting 206
  - staples, loading 156
  - stapling 155, 156
  - status
    - alerts, HP ToolboxFX 144
    - fax job 11
    - Macintosh services tab 34
    - supplies, checking 157
    - viewing with
      - HP ToolboxFX 144
  - Status tab, HP ToolboxFX 144
  - storing
    - environmental specifications 225
    - print cartridges 158
  - streaks, troubleshooting 191
  - supplies
    - HP fraud hotline 158
    - recycling 158, 229
    - replacing print cartridges 159
    - reusing 159
    - status page, printing 142
    - status, checking 157
    - status, viewing with
      - HP ToolboxFX 144
    - storing 158
  - supply-status, Services tab
    - Macintosh 34
  - support
    - online 220
    - repacking device 221
  - supported media 47
  - SupportPack, HP 222
  - System Settings tab, 149
  - System setup menu 17
- T**
- TCP/IP
    - operating systems
      - supported 38
    - protocols supported 39
  - technical support
    - online 220
    - repacking device 221
  - Telephone Consumer Protection Act 233
  - telephone numbers
    - HP fraud hotline 158
  - telephones
    - receiving faxes from 115, 128
  - telephones, connecting extra 97
  - telephones, downstream
    - sending faxes from 126
  - temperature specifications
    - environment 225
  - terminology 239
  - text, troubleshooting 192
  - tone-dialing 108
  - toner
    - loose, troubleshooting 192
    - saving 61
    - scatter, troubleshooting 194
    - smeared, troubleshooting 191
    - specks, troubleshooting 190
  - Toolbox. See HP ToolboxFX
  - transfer unit warranty 219
  - tray 1
    - jams, clearing 180
    - loading 49
    - locating 4
  - tray 2
    - jams, clearing 180
    - loading 50
    - locating 4
  - tray 3
    - jams, clearing 180
    - loading 50



- locating 4
  - part number 214
  - trays
    - capacity 54
    - copying, changing
      - selection 51
    - default media size 51
    - double-sided printing 34
    - double-sided printing,
      - Windows 63
    - feeding problems,
      - troubleshooting 195
    - jams, clearing 180
    - locating 4
    - part numbers 214
  - troubleshooting
    - blank pages 196
    - blank scans 203
    - checklist 168
    - configuration page,
      - printing 41
    - control panel messages 170
    - control-panel display 176
    - copy quality 198
    - copy size 200
    - copying 200
    - critical error messages 174
    - curled media 193
    - dialing 137
    - EPS files 209
    - faded print 190
    - fax error-correction
      - setting 135
    - fax reports 140
    - feeding problems 195
    - jams 176
    - lines, copies 198
    - lines, printed pages 191
    - lines, scans 203
    - loose toner 192
    - network configuration page,
      - printing 41
    - networks 206
    - pages not printing 197
    - pages too dark 198
    - pages too light 198
    - paper 194
    - print quality 190
    - receiving faxes 138
    - repetitive defects 194
    - scan quality 201, 203
    - sending faxes 136
    - skewed pages 193, 195
    - speed, faxing 140
    - staple jams 188
    - stapler 206
    - text 192
    - toner scatter 194
    - toner smear 191
    - toner specks 190
    - USB cables 197
    - wrinkles 193
  - TWAIN-compliant software,
    - scanning from 84
  - types, media
    - HP ToolboxFX settings 150
    - tray selection 54
- U**
- unblocking fax numbers 114
  - uninstalling
    - Windows software 24
  - uninstalling Macintosh
    - software 30
  - UNIX 26
  - UNIX software 26
  - usage page, printing 142
  - USB port
    - locating 5
    - Macintosh installation 29
    - troubleshooting 197
    - troubleshooting
      - Macintosh 209
    - type included 3
  - Use different paper/covers 59
  - user-replaceable parts 215
- V**
- V.34 setting 135
  - vertical lines,
    - troubleshooting 191
  - vertical white or faded
    - stripes 198
  - voltage requirements 224
  - volume
    - settings 18
  - volume, adjusting 105
- W**
- warning messages 170
  - warranty
    - Customer self repair 218
    - extended 222
    - print cartridge 219
    - product 217
    - transfer unit and fuser 219
  - watermarks 33, 61
  - wavy paper, troubleshooting 193
  - Web sites
    - customer support 220
    - HP Web Jetadmin,
      - downloading 154
    - Macintosh customer
      - support 221
    - Material Safety Data Sheet
      - (MSDS) 231
  - weekly on-site service 221
  - weight 224
  - white or faded stripes,
    - troubleshooting 198
  - WIA-compliant software, scanning
    - from 84
  - Windows
    - add scan-to destinations 85
    - driver settings 23, 62
    - drivers supported 7, 22
    - faxing from 124
    - pages per sheet 64
    - problem-solving issues 208
    - scanning from TWAIN or WIA
      - software 84
    - scanning to e-mail 86
    - scanning to folder 86
    - software components 21, 25
    - supported operating
      - systems 6, 22
  - Windows driver settings
    - booklets 57
  - Word, faxing from 125
  - wrinkles, troubleshooting 193







© 2007 Hewlett-Packard Development Company, L.P.

[www.hp.com](http://www.hp.com)



CB532-90949