



HP Digital Sender Flow 8500 fn1

User Guide

Copyright and license

© 2013 Copyright Hewlett-Packard Development Company, L.P.

Reproduction, adaptation or translation without prior written permission is prohibited, except as allowed under the copyright laws.

The information contained herein is subject to change without notice.

The only warranties for HP products and services are set forth in the express warranty statements accompanying such products and services. Nothing herein should be construed as constituting an additional warranty. HP shall not be liable for technical or editorial errors or omissions contained herein.

Trademark credits

ENERGY STAR is a U.S. registered service mark of the United States Environmental Protection Agency.

Microsoft and Windows are registered trademarks of Microsoft Corporation.

Edition 1, 4/2013

Table of contents

1 Product basics	1
Product features	1
Front view	3
Back view	4
Sleep Mode	4
Auto-shutdown feature	5
2 Control panel	7
Control-panel layout	7
Interpret control panel status lights	9
Control panel messages	9
Home screen	10
Buttons on the touch screen	11
Control-panel help system	11
3 Administration - Configure the product	13
Supported utilities for Windows	13
HP Web Jetadmin	13
Embedded Web Server	13
HP Digital Sending Software (HP DSS)	14
Supported network protocols	14
Supported e-mail protocols	15
Basic configuration using the Administration menu	16
Navigate the Administration menu	16
Jetdirect menus	17
Configure language settings	23
Configure time settings	24
Assign IP address	24
Set up and configure e-mail settings using the E-mail Setup Wizard	25
Manually configure IPv4 TCP/IP parameters from the control panel	25
Manually configure IPv6 TCP/IP parameters from the control panel	26
Disable network protocols (optional)	26
Link speed and duplex settings	26
Basic configuration using the Embedded Web Server	27
View or change network settings	27
Set or change the administrator password	27

Configure e-mail options	28
Save to Network Folder Setup	28
Configure save to SharePoint options	29
Configure USB storage device settings	29
Configure Quick Sets	30
Configure general security settings	30
Configure access control security settings	30
Additional configuration using the Embedded Web Server	31

4 Administration - Manage the product 33

Use information pages	33
Use the Embedded Web Server	34
Open the Embedded Web Server	34
Embedded Web Server options	34
Use HP Web Jetadmin software	35
Controlling digital-sending security	35
Network authentication	36
Secure e-mail	36
Restrict software access	36
Security features	36
Secure the Embedded Web Server	36
Manage temporary job files	37
Secure Storage Erase	37
Data affected	38
Secure File Erase	38
Secure Disk Erase	38
HP High-Performance Secure Hard Disks	38
Manage certificates	38
Load a certificate	39
Load a certificate revocation list (CRL)	39
Authentication and authorization	39
Energy settings	40
Upgrade the firmware	40
Backup product data	41
Restore product data	41

5 Load originals 43

Use the automatic document feeder (ADF)	43
Document loading tips	43
Document loading tips for mixed-size documents	44
How to load documents	45

Use the scanning glass	46
6 Scan and send documents	49
Sign in	49
New scanner features	49
Preview a scan	50
Use the Image Preview screen	51
Send a scanned document to one or more e-mails	52
Use the address book	52
Create a recipient list	52
Use the Personal or Shared Contacts address book	52
Add entries to the Personal or Shared Contacts address books	53
Delete entries from the Personal Contacts address book	53
Use the Send E-mail screen	53
Send documents	54
Send a document	54
Use the auto-complete function	54
Fax a scanned document	55
Use the Send Fax screen	55
Send a fax	56
Save to a network folder or USB storage device	56
Save to a SharePoint site	57
Send or save a document using Quick Sets	57
Scan to a workflow destination	57
7 Maintain the product	59
Order maintenance and scanning supplies	59
Clean the touch screen	59
Clean the scanning glass, scanning strip, and automatic document feeder (ADF) duplex background	59
Clean the rollers	62
8 Replace and install components	65
Replace the rollers	65
Replace the separation pad	68
Replace the front panel	72
Replace the keyboard	74
Replace the hard drive	76
Install a Jetdirect card	79
Install an accessory into the hardware integration pocket	80

9 Troubleshooting	83
Scan errors	83
Basic troubleshooting tips	84
Installation problems	85
Initialization or hardware problems	85
Check the Ethernet connection	85
Check that the product has power	86
Reset the product	86
The product has paused or shut down	86
The product is displaying a “pause” message on the touch screen	86
I received an e-mail indicating that the product has shut down	86
Paper feeding problems	87
Paper jamming, skewing, misfeeds, or multiple-page feeds	87
Scanning fragile originals	87
Paper does not feed from the product	87
Originals are curling up in the document output tray	88
The bottom of the scanned image is cut off	88
The scanned images have streaks or scratches	88
An item loaded in the document input tray jams repeatedly	88
Clear jams from the paper path	89
The product has stopped working correctly	90
Solve e-mail problems	90
Validate the SMTP gateway address	90
Validate the LDAP gateway address	91
Solve network problems	91
Restore factory settings	92
Contact HP Support	92
10 Specifications and warranty	93
Product specifications	93
Document feeder specifications	93
Environmental specifications	94
Certificate of Volatility	94
Volatile memory	94
Non-volatile memory	94
Hard disk drive memory	95
Regulatory model number	95
Environmental product stewardship program	95
Protecting the environment	95
Plastics	95
Energy information	95

Material restrictions	96
Disposal of waste equipment by users in private households in the European Union	96
Chemical substances	97
For more information	97
Hewlett-Packard limited warranty statement	97

Index	99
--------------------	-----------

1 Product basics

This User Guide covers what you need to know about using your product.

- [Product features](#)
- [Front view](#)
- [Back view](#)
- [Sleep Mode](#)
- [Auto-shutdown feature](#)

Product features

Table 1-1 Features

Resolution	600 pixels per inch (ppi)
Memory	<ul style="list-style-type: none">• 1792 MB of random-access memory (RAM).<ul style="list-style-type: none">◦ 512 MB on formatter◦ 1024 MB on scanner◦ 256 on Jetdirect Inside (JDI) networking• Memory Enhancement technology (MEt) automatically compresses data to use RAM more efficiently.
User interface	<ul style="list-style-type: none">• HP Easy Select full color control panel• Embedded Web Server (EWS) to configure the product and gain access to support
Paper-handling	<ul style="list-style-type: none">• Document feeder: Holds up to 100 sheets of paper.• Two-sided scanning: The document feeder has an automatic duplexer for scanning two-sided documents.• Blank page suppression: Suppresses blank pages in scanned output (works best with white or light-colored pages).• Standard output tray: The output tray is located near the bottom of the product.• HP Precision Feed technology with multiphase pick process, advanced separation and intelligent picking technologies, mixed-stack handling, and ultrasonic double-feed detection.

Table 1-1 Features (continued)

Connectivity	<ul style="list-style-type: none">• Local area network (LAN) connector (RJ-45) for Jetdirect Inside (JDI)• One enhanced input/output (EIO) slot• Covered USB 2.0 connection for FAT-formatted portable storage device. The Administrator must enable this USB port before it can be used. NOTE: USB-connected external hard drives are not supported.• Optional HP Digital Sending Software (DSS).• Hardware integration pocket.
Environmental features	<ul style="list-style-type: none">• Sleep Timer Settings saves energy by causing the scanner to default to Sleep Mode after 15 minutes of inactivity.• High content of recyclable components and materials• ENERGY STAR® qualified
Security features	<ul style="list-style-type: none">• Secure disk erase• Secure storage erase• Secure file erase• Authentication<ul style="list-style-type: none">◦ User access code authentication◦ Windows (Kerberos and NTLM)◦ LDAP• Jetdirect Inside (JDI)<ul style="list-style-type: none">◦ IPsec◦ Password protection◦ SSL◦ TLS◦ SNMPv3

Table 1-1 Features (continued)

	<ul style="list-style-type: none">◦ 802.1x authentication◦ IPP over TLS• Secure communication between the product and network servers• IPsec security (hardware)• HP High-Performance Secure Hard Disk
Scanning and sending	<ul style="list-style-type: none">• Modes for text, graphics, and mixed text and graphics formats• Embedded OCR• Job-interrupt feature• Control-panel animations (for example, jam recovery)• Scan and send to e-mail, fax, network folder, USB device, and SharePoint<ul style="list-style-type: none">◦ Address book for e-mail and fax◦ Send to digital fax (Internet and LAN fax)• Retrieve contacts from a network directory (LDAP)• Automatic duplex (two-sided) scanning

Front view

⚠ CAUTION: If you need to move the product, always lift the product from the base. Do not lift using the keyboard.

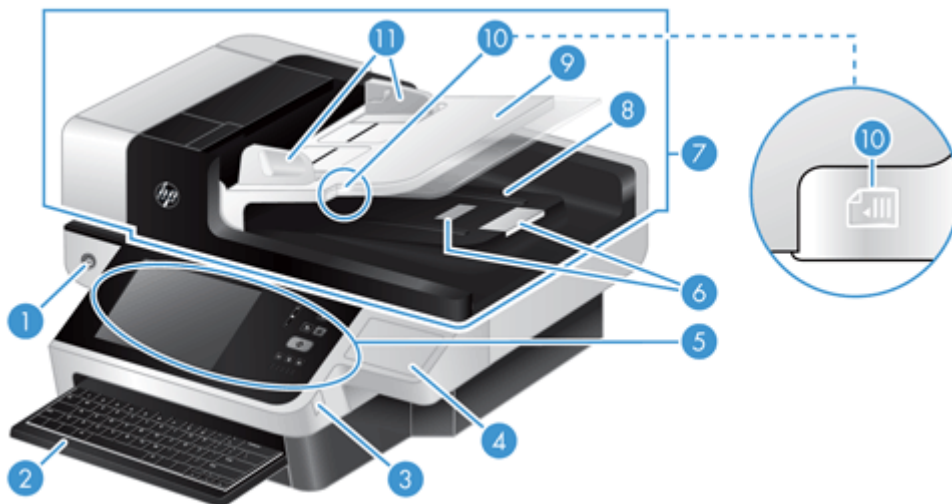

1	Power button
2	Keyboard
3	Covered USB connector for FAT-formatted portable storage device
4	Covered hardware integration pocket
5	Control panel

6	Paper stops
7	Automatic document feeder (ADF)
8	ADF output tray
9	ADF input tray
10	Document load/detect LED
11	Paper guides

Back view

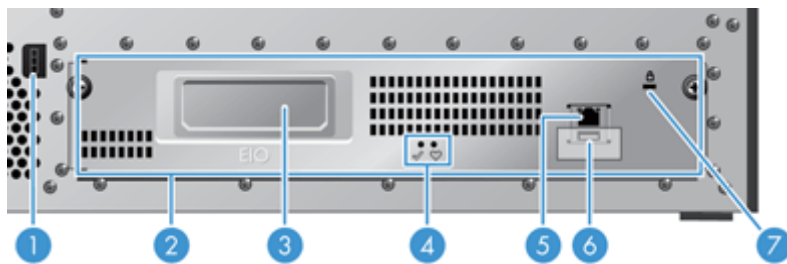

1	Power connector
2	Rear panel drawer assembly
3	EIO card slot
4	Formatter status LEDs (both are green; under normal conditions, the left LED is on steady and the right LED blinks)
5	Ethernet port
6	USB host port (under user-removable label)
7	Slot for a cable-type security lock

Sleep Mode

The scanner will enter Sleep Mode after 15 minutes of inactivity. To exit Sleep Mode, do any one of the following:

- Press any button
- Touch the touch screen
- Lift the flatbed scanner lid
- Connect a USB device

Auto-shutdown feature

This product is equipped with a safety feature that protects from overheating due to a blocked fan vent or a fan failure.

- Under some conditions, the touch screen will display a “pause” message for 12 minutes before initiating shutdown.
- If the product detects that the fan has failed (causing the drive to overheat), the product will shut itself down. If this occurs, the product will send e-mail to notify the current user (if the user is logged in) and the administrator of the shutdown.





2 Control panel



- [Control-panel layout](#)
- [Interpret control panel status lights](#)
- [Control panel messages](#)
- [Home screen](#)
- [Buttons on the touch screen](#)
- [Control-panel help system](#)

Control-panel layout

The control panel includes a touch screen graphical display, job-control buttons, a keyboard, and three light-emitting diode (LED) status lights.

















1	Touch screen	Use the touch screen to access product functions.
2	 Touch screen brightness-adjustment control	Use this control to increase or decrease the brightness of the touch screen display.
3	 Reset button	Resets the job settings to factory or user-defined default values.
4	 Ready LED	The Ready LED indicates that the product is ready to begin processing any job.
5	 Data LED	The Data LED indicates that the product is receiving data.
6	 Attention LED	The Attention LED indicates that the product has a condition that requires intervention.

7		Start button	Starts digital sending (e-mail and fax, for example), or continues a job that has been interrupted.
8		Stop button	Stops the active job and opens the Job Status screen.
9		Sleep button	If the product is inactive for a long period of time, it automatically enters a sleep mode. To place the product into sleep mode or to reactivate the product, press the Sleep button.

Interpret control panel status lights

The product has six LEDs on the control panel that indicate product status. The table below explains how to interpret these LEDs.

LED behavior	Description
All LEDs are off.	The product is turned off.
Sleep LED  is on.	The scanner is in sleep (power conservation) mode.
Sleep LED  is flashing.	The scanner is entering or exiting sleep mode.
Sleep LED  is off.	The scanner is not in sleep mode, nor is it transitioning sleep status (on or off).
Power LED  is on.	The product is powered on.
Power LED  is blinking.	The AC adapter is plugged in to the product, and the product is turned off.
Power LED  is off.	The power supply is not providing power to the product.
Ready LED  is on.	The product is online and able to accept input.
Ready LED  is flashing.	The product is pausing a request or has stopped receiving input.
Ready LED  is off.	The product is paused and unable to accept input. This may be because the product was deliberately paused, or because the product is in an error state.
Data LED  is on.	The product has data buffered that it has finished processing and is waiting for more data to be transmitted, or the product is paused. When the Attention LED is flashing at the same time, there is an error and there is data waiting to be processed.
Data LED  is flashing.	The product is receiving or processing data.
Data LED  is off.	There is no data for the product to process.
Attention LED  is on.	The product has encountered a critical error, the nature of which is indicated on the display.
Attention LED  is flashing quickly.	The product has encountered an error which requires user intervention, such as a jam in the automatic document feeder.
Attention LED  is off.	No error condition exists.



NOTE: Status and error conditions appear on the display.

Control panel messages

The product provides robust control panel messaging. When a message appears on the control panel, follow the on-screen instructions to resolve the issue. If the product displays an “Error” or “Attention” message, and no steps are shown to resolve the issue, turn the product off then on. Contact HP support if you continue to experience issues with the product.

To get additional information for warnings that appear in the status line, touch the Warning button.

For additional information on a variety of topics, touch the Help button in the upper-right corner of the Home screen.

Home screen



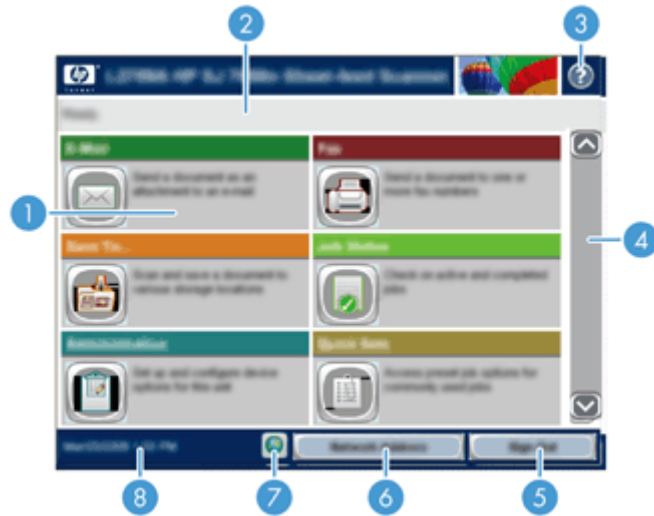



The Home screen provides access to the product features, and it indicates the current status of the product.



<p>1 Features</p>	<p>Depending on how the product is configured, the features that appear in this area can include any of the following items:</p> <ul style="list-style-type: none"> • Fax • E-mail • Job Status • Save to Network Folder • Save to USB • Quick Sets • Workflow • Administration • Service
<p>2 Product status line</p>	<p>The status line provides information about the overall product status. Various buttons appear in this area, depending on the current status.</p>
<p>3 Help button</p>	<p>Touch the Help button to open the embedded help system.</p>
<p>4 Scroll bar</p>	<p>Touch the up or down arrows on the scroll bar to see the complete list of available features.</p>
<p>5 Sign In/Sign Out</p>	<p>Touch this button to sign in or sign out of the product. After you sign out, the product restores all options to the default settings.</p>
<p>6 Network Address button</p>	<p>Touch the Network Address button to find information about the network connection.</p>
<p>7 Language button</p>	<p>Touch the Language button to open the Language screen and change the touch screen display language.</p>
<p>8 Date and time</p>	<p>The current date and time appear here. You can select the format that the product uses to show the date and time, for example 12-hour format or 24-hour format.</p>

Buttons on the touch screen

The touch screen provides information about the product status. Various buttons can appear in this area.

	Home button. Touch this button to go to the Home screen from any other screen.
	Start button. Touch this button to begin the action for the feature that you are using. NOTE: The name of this button changes for each feature. For example, in the digital fax feature, the button is named Send Fax .
	Error button. This button appears whenever the product has an error that requires attention before it can continue. Touch the Error button to see a message that describes the error. The message also has instructions for solving the problem.
	Warning button. This button appears when the product has a problem but can continue functioning. Touch the Warning button to see a message that describes the problem. The message also has instructions for solving the problem.
	Help button. Touch this button to open the built-in online Help system.
	Language button. Touch this button to open the Language screen and set the touch screen display language.

Control-panel help system

The product has a built-in Help system that explains how to use each screen. To open the Help system, touch the Help button in the upper-right corner of the screen.

For some screens, the Help opens to a global menu where you can search for specific topics. You can browse through the menu structure by touching the buttons in the menu.

For screens that contain settings for individual jobs, the Help opens to a topic that explains the options for that screen.

If the product alerts you of an error or warning, touch the Error or Warning button to open a message that describes the problem. The message also contains instructions to help solve the problem.

3 Administration - Configure the product

A network administrator will need to configure the product for use on the network, so you can scan to e-mail and other destinations. The configuration settings are accessible from the Embedded Web Server, HP Web Jetadmin software, or the control panel.

- [Supported utilities for Windows](#)
- [Supported network protocols](#)
- [Supported e-mail protocols](#)
- [Basic configuration using the Administration menu](#)
- [Basic configuration using the Embedded Web Server](#)
- [Additional configuration using the Embedded Web Server](#)

Supported utilities for Windows

- [HP Web Jetadmin](#)
- [Embedded Web Server](#)
- [HP Digital Sending Software \(HP DSS\)](#)

HP Web Jetadmin

HP Web Jetadmin is a simple print and imaging peripheral management software tool that helps optimize product use, control color costs, secure products, and streamline supplies management by enabling remote configuration, proactive monitoring, security troubleshooting, and reporting of printing and imaging products.

To download a current version of HP Web Jetadmin and for the latest list of supported host systems, visit www.hp.com/go/webjetadmin.

When installed on a host server, a Windows client can gain access to HP Web Jetadmin by using a supported Web browser (such as Microsoft® Internet Explorer) by navigating to the HP Web Jetadmin host.

Embedded Web Server

The product is equipped with an Embedded Web Server, which provides access to information about product and network activities. This information appears in a Web browser, such as Microsoft Internet Explorer or Mozilla Firefox.

The Embedded Web Server resides on the product. It is not loaded on a network server.

The Embedded Web Server provides an interface to the product that anyone who has a network-connected computer and a standard Web browser can use. No special software is installed or configured, but you must have a supported Web browser on your computer. To gain access to the Embedded Web Server, type the IP address for the product in the address line of the browser. (To find the IP address, touch the [Network Address](#) button on the Home screen.)

HP Digital Sending Software (HP DSS)

You can install the optional HP Digital Sending Software. This software runs as a service on a network server and allows multiple products to send jobs through the server. It is not necessary to install any software or drivers on individual users' computers. For information about compatible versions of HP DSS and to purchase the software, see www.hp.com/go/dss.

Supported network protocols

The product supports the TCP/IP network protocol, the most widely used and accepted networking protocol. Many networking services utilize this protocol. The following tables list the supported networking services and protocols.

Table 3-1 Network device discovery

Service name	Description
SLP (Service Location Protocol)	Device-discovery protocol, used to help find and configure network devices. Used primarily by Microsoft-based programs.

Table 3-2 Messaging and management

Service name	Description
HTTP (Hyper Text Transfer Protocol)	Allows Web browsers to communicate with the Embedded Web Server.
EWS (Embedded Web Server)	Allows you to manage the product through a Web browser.
SNMP (Simple Network Management Protocol)	Used by network applications for product management. SNMP v1, SNMP v3, and standard MIB-II (Management Information Base) objects are supported.
LLMNR (Link Local Multicast Name Resolution)	Specifies if the product responds to LLMNR requests over IPv4 and IPv6.
TFTP Configuration	Use TFTP to download a configuration file containing additional configuration parameters, such as SNMP or non-default settings, for Jetdirect Inside (JDI).

Table 3-3 IP addressing

Service name	Description
DHCP (Dynamic Host Configuration Protocol)	For automatic IPv4 and IPv6 address assignment. The DHCP server provides the product with an IP address. Generally, no user intervention is required for the product to obtain an IP address from a DHCP server.
BOOTP (Bootstrap Protocol)	For automatic IP address assignment. The BOOTP server provides the product with an IP address. Requires the administrator to input a product's MAC hardware address on the BOOTP server for the product to obtain an IP address from that server.
Auto IP	For automatic IP address assignment. If neither a DHCP server nor a BOOTP server is present, the product uses this service to generate a unique IP address.
Manual	For manual IP address assignment. Requires the administrator to manually assign a static IP address.

Table 3-4 Security features

Service name	Description
IPsec/Firewall	Provides network-layer security on IPv4 and IPv6 networks. A firewall provides simple control of IP traffic. IPsec provides additional protection through authentication and encryption protocols.
SNMP v3	Employs a user-based security model for SNMP v3, which provides user authentication and data privacy through encryption.
Access control list (ACL)	Specifies the individual host systems, or networks of host systems, that are allowed to access the server and the attached network product.
SSL/TLS	Allows you to transmit private documents via the Internet and guarantee privacy and data integrity between the client and server applications.
IPsec batch configuration	Provides network-layer security through the simple control of IP traffic to and from the product. This protocol provides the benefits of encryption and authentication and allows for multiple configurations.

Supported e-mail protocols

The product supports Simple Mail Transfer Protocol (SMTP) and Lightweight Directory Access Protocol (LDAP).

SMTP

- SMTP is a set of rules that define the interaction between programs that send and receive e-mail. In order for the product to send documents to e-mail, it must be connected to a LAN that has access to an e-mail server that supports SMTP. The SMTP server must also have Internet access.
- If you are using a LAN connection, contact your system administrator to obtain the IP address or host name for your SMTP server. If you are connecting through a DSL or cable connection, contact the internet service provider to obtain the SMTP server IP address.

LDAP

- LDAP is used to gain access to a database of information. When the product uses LDAP, it searches a global list of e-mail addresses. As you begin to type the e-mail address, LDAP uses an auto-complete feature that supplies a list of e-mail addresses that match the characters you type. As you type additional characters, the list of matching e-mail addresses becomes smaller.
- The product supports LDAP, but a connection to an LDAP server is not required in order for the product to be able to send to e-mail.

 **NOTE:** If you need to change the LDAP settings, you must change them using the Embedded Web Server.

Basic configuration using the Administration menu

You can use the [Initial Setup](#) application to complete this subset of configuration tasks if you have not disabled [Initial Setup](#) on the Home screen: set language settings, configure date and time format, set date and time, and access the E-mail Setup Wizard.

- [Navigate the Administration menu](#)
- [Configure language settings](#)
- [Configure time settings](#)
- [Assign IP address](#)
- [Set up and configure e-mail settings using the E-mail Setup Wizard](#)
- [Manually configure IPv4 TCP/IP parameters from the control panel](#)
- [Manually configure IPv6 TCP/IP parameters from the control panel](#)
- [Disable network protocols \(optional\)](#)
- [Link speed and duplex settings](#)

Navigate the Administration menu

From the Home screen, touch the [Administration](#) button to open the menu structure. You might need to scroll to the bottom of the Home screen to see this feature.

The [Administration](#) menu has several sub-menus that you can use for some setup tasks. (Use the Embedded Web Server to configure all settings.) Touch the name of a menu to expand the structure. A plus sign (+) next to a menu name means that it contains sub-menus. Continue opening the structure

until you reach the option that you want to configure. To return to the previous level, touch the Back button .

 **NOTE:** The Back button  is not available on all screens.

To exit the [Administration](#) menu, touch the Home button  in the upper-left corner of the screen.

The product has built-in Help that explains each of the features that are available through the menus. Help is available for many menus on the right-hand side of the touch screen.

The table in this section provides general information about each menu. For information about specific entries in each menu, see the built-in Help.

Table 3-5 Administration menus

Menu item	Description
Reports	Use this menu to view information pages and reports that are stored internally on the product.
General Settings	Use this menu to set options for setting the time and period of inactivity before the product enters sleep mode.
Scan/Digital Send Settings	Use this menu to set up e-mail, save-to-network-folder, save-to-USB-device, and digital-send-service options.
Fax Settings	Use this menu to set up fax-send options.
Display Settings	Use this menu to set up basic display and device behavior settings (keypress sound, display language, network address button display, scanner inactivity timeout, and more).
Network Settings	Use this menu to set up I/O timeout options and to access the Jetdirect menu.
Troubleshooting	Use this menu to help resolve problems. Available options include access to event logs and diagnostic tests, ability to retrieve diagnostic data, and ability to generate debugging data.

Jetdirect menus

[Administration](#) > [Network Settings](#) > [Embedded Jetdirect Menu](#)

Table 3-6 Jetdirect menus

Menu item	Sub-menu item	Sub-menu item	Values and Description
Information	Print Sec Report		Yes: Print the security report.
			No (default): Do not print the security report.
TCP/IP	Enable		On (default): Enable the TCP/IP protocol.
			Off: Disable the TCP/IP protocol.
	Host Name		An alphanumeric string, up to 32 characters, used to identify the product. This name is listed on the HP Jetdirect configuration page. The default host name is NPIxxxxxx, where xxxxxx is the last six digits of the LAN hardware (MAC) address.

Table 3-6 Jetdirect menus (continued)

Menu item	Sub-menu item	Sub-menu item	Values and Description
	IPv4 Settings	Config Method	<p>Specifies the method that TCP/IPv4 parameters will be configured on the HP Jetdirect server.</p> <p>Bootp: Use BOOTP (Bootstrap Protocol) for automatic configuration from a BOOTP server.</p> <p>DHCP: Use DHCP (Dynamic Host Configuration Protocol) for automatic configuration from a DHCPv4 server. If selected and a DHCP lease exists, DHCP Release and DHCP Renew menus are available to set DHCP lease options.</p> <p>Auto IP: Use automatic link-local IPv4 addressing. An address in the form 169.254.x.x is assigned automatically.</p> <p>Manual: Use the Manual Settings menu to configure TCP/IPv4 parameters.</p>
		Default IP	<p>Specify the IP address to default to when the Jetdirect server is unable to obtain an IP address from the network during a forced TCP/IP reconfiguration (for example, when manually configured to use BOOTP or DHCP).</p> <p>Auto IP: A link-local IP address 169.254.x.x is set.</p> <p>Legacy: The address 192.0.0.192 is set, consistent with older HP Jetdirect products.</p>
		DHCP Release	<p>This menu appears if the Config Method item was set to the DHCP value and a DHCP lease for the Jetdirect server exists.</p> <p>Yes: The current DHCP lease and the leased IP address are released.</p> <p>No (default): The current DHCP lease is saved.</p>
		DHCP Renew	<p>This menu appears if the Config Method item was set to the DHCP value and a DHCP lease for the Jetdirect server exists.</p> <p>Yes: The Jetdirect server requests to renew the current DHCP lease.</p> <p>No (default): The Jetdirect server does not request to renew the DHCP lease.</p>

Table 3-6 Jetdirect menus (continued)

Menu item	Sub-menu item	Sub-menu item	Values and Description
		Manual Settings	<p>(Available only if the Config Method item is set to the Manual value) Configure parameters directly from the control panel:</p> <p>IP Address: The unique IP address of the product (n.n.n.n), where n is a value from 0 to 255.</p> <p>Subnet Mask: The subnet mask for the product (m.m.m.m), where m is a value from 0 to 255.</p> <p>Syslog Server: The IP address of the syslog server used to receive and log syslog messages.</p> <p>Default Gateway: The IP address of the gateway or router used for communications with other networks.</p> <p>Idle Timeout: The time period, in seconds, after which an idle TCP data connection is closed (default is 270 seconds, 0 disables the timeout).</p>
		Primary DNS	Specify the IP address (n.n.n.n) of a Primary DNS Server.
		Secondary DNS	Specify the IP address (n.n.n.n) of a Secondary Domain Name System (DNS) Server.
	IPv6 Settings	Enable	<p>Use this item to enable or disable IPv6 operation on the server.</p> <p>On (default): IPv6 is enabled.</p> <p>Off: IPv6 is disabled.</p>
		Address	Type the server address, a 32 hexadecimal digit IPv6 node address that uses the colon hexadecimal syntax.
		Manual	<p>Use this item to manually set IPv6 addresses on the server.</p> <p>Enable: Select this item and choose the On setting to enable manual configuration, or the Off setting to disable manual configuration.</p> <p>Address: Use this item to type a 32 hexadecimal digit IPv6 node address that uses the colon hexadecimal syntax.</p>

Table 3-6 Jetdirect menus (continued)

Menu item	Sub-menu item	Sub-menu item	Values and Description
		DHCPv6 Policy	<p>Router Specified: The stateful auto-configuration method to be used by the Jetdirect server is determined by a router. The router specifies whether the Jetdirect server obtains its address, its configuration information, or both from a DHCPv6 server.</p> <p>Router Unavailable (default): If a router is not available, the Jetdirect server should attempt to obtain its stateful configuration from a DHCPv6 server.</p> <p>Always: Whether or not a router is available, the Jetdirect server always attempts to obtain its stateful configuration from a DHCPv6 server.</p>
		Primary DNS	Use this item to specify an IPv6 address for a primary DNS server that the Jetdirect server should use.
		Secondary DNS	Use this item to specify an IPv6 address for a secondary DNS server that the Jetdirect server should use.
	Proxy Server		<p>Specifies the proxy server to be used by embedded applications in the product. A proxy server is typically used by network clients for Internet access. It caches Web pages, and provides a degree of Internet security, for those clients.</p> <p>To specify a proxy server, enter its IPv4 address or fully-qualified domain name. The name can be up to 255 octets.</p> <p>For some networks, you may need to contact your Independent Service Provider (ISP) for the proxy server address.</p>
	Proxy Port		Type the port number used by the proxy server for client support. The port number identifies the port reserved for proxy activity on your network, and can be a value from 1 to 65535.
	Idle Timeout		The time period, in seconds, after which an idle TCP data connection is closed, and can be a value from 0 to 3600 (default is 270 seconds, 0 disables the timeout).
Security	Secure Web		<p>For configuration management, specify whether the Embedded Web Server will accept communications using HTTPS (Secure HTTP) only, or both HTTP and HTTPS.</p> <p>HTTPS Required: For secure, encrypted communications, only HTTPS access is accepted. The Jetdirect server will appear as a secure site.</p> <p>HTTPS Optional (default): Access using either HTTP or HTTPS is permitted.</p>

Table 3-6 Jetdirect menus (continued)

Menu item	Sub-menu item	Sub-menu item	Values and Description
	IPSec		Specify the IPSec status on the Jetdirect server. <i>Keep</i> : IPSec or firewall status remains the same as currently configured. <i>Disable</i> (default): IPSec or firewall operation on the Jetdirect server is disabled.
		802.1X	Reset 802.1X settings to factory defaults. <i>Reset</i> : Reset 802.1X settings to factory defaults. <i>Keep</i> (default): Retain current 802.1X settings.
		Announcement Agent	Set announcement agent preferences. <i>Enable</i> (default): Enable the announcement agent. <i>Disable</i> : Disable the announcement agent.
		Reset Security	Specify whether the current security settings on the Jetdirect server will be saved or reset to factory defaults. <i>Yes</i> : Security settings are reset to factory defaults. <i>No</i> (default): The current security settings are maintained.
Diagnostics	Embedded Tests	LAN HW Test	<i>Yes</i> : Run a LAN hardware test. <i>No</i> (default): Do not run a LAN hardware test.
		HTTP Test	<i>Yes</i> : Run an HTTP test. <i>No</i> (default): Do not run an HTTP test.
		SNMP Test	<i>Yes</i> : Run an SNMP test. <i>No</i> (default): Do not run an SNMP test.
		Data Path Test	<i>Yes</i> : Run a data path test. <i>No</i> (default): Do not run data path test.
		Select All Tests	<i>Yes</i> : Select all tests. <i>No</i> (default): Do not select all tests.
		Execution Time (H)	Set the time delay, in hours, for test execution. When you click <i>Execute</i> , the selected tests will execute after this interval. Valid values are 0–24, default is 1.
		Execute	<i>Yes</i> : Execute the selected tests.. <i>No</i> (default): Do not execute the selected tests.

Table 3-6 Jetdirect menus (continued)

Menu item	Sub-menu item	Sub-menu item	Values and Description
	Ping Test	Dest Type	Select the destination type for this test. IPV4 (default) IPV6
		Dest IPv4	Enter the IP address for the IPv4 destination.
		Dest IPv6	Enter the IP address for the IPv6 destination.
		Packet Size	Specify the packet size for this test. Valid values are 64–2048, default is 64.
		Timeout	Set the timeout value for this test. Valid values are 1–100, default is 1.
		Count	Set the count value for this test. Valid values are 0 – 100, default is 4.
		Print Results	Yes: Print test results. No (default): Do not print test results.
		Execute	Yes: Execute the selected tests.. No (default): Do not execute the selected tests.
	Ping Results	Packets Sent	Number of packets sent. Valid values are 0–65535.
		Packets Received	Number of packets received. Valid values are 0–65535.
		Percent Lost	Percent of loss. Valid values are 0–100.
		RTT Min	Valid values are 0–4096.
		RTT Max	Valid values are 0–4096.
		RTT Average	Valid values are 0–4096.
		Ping in Progress	Yes No

Table 3-6 Jetdirect menus (continued)



Menu item	Sub-menu item	Sub-menu item	Values and Description
		Refresh	Yes No
Link Speed			<p>The link speed and communication mode of the Jetdirect server must match the network. The available settings depend on the product and installed Jetdirect server. Select one of the following link configuration settings:</p> <p>CAUTION: If you change the link setting, network communications with the Jetdirect server and network product might be lost.</p> <p>Auto (default): The Jetdirect server uses auto-negotiation to configure itself with the highest link speed and communication mode allowed. If auto-negotiation fails, either the 100TX Half value or the 10T Half value is set depending on the detected link speed of the hub/switch port. (A 1000T half-duplex selection is not supported.)</p> <p>10T Half: 10 Mbps, half-duplex operation.</p> <p>10T Full: 10 Mbps, full-duplex operation.</p> <p>100TX Half: 100 Mbps, half-duplex operation.</p> <p>100TX Full: 100 Mbps, full-duplex operation.</p> <p>100TX Auto: Limits auto-negotiation to a maximum link speed of 100 Mbps.</p> <p>1000T Full: 1000 Mbps, full-duplex operation.</p>

Configure language settings

To configure language settings, follow these steps:

1. At the product control panel, touch the **Administration** button, touch the **Display Settings** menu, and then touch the **Language Settings** option.
2. Under **Language**, touch the language for the control panel display.
3. Under **Keyboard Layout**, touch the keyboard layout for the touch screen keyboard, and then touch **Save**.

 **NOTE:** The language you select can impact the organization of the keys on the touch screen keyboard. Also note that there may be more than one keyboard layout for a specific language.

 **NOTE:** You can also configure language settings by touching the **Language** button  on the Home screen.

Configure time settings

To configure time settings, follow these steps:

1. At the product control panel, touch the [Administration](#) button, touch the [General Settings](#) menu, and then touch the [Date/Time Settings](#) option.
2. Set the date and time.
 - a. Touch [Date/Time](#).
 - b. Set the date, month, and year by touching the appropriate button and using the arrow to set the desired value.
 - c. Set the time by touching the appropriate button and using the arrow to set the desired value; touch the [AM/PM](#) button to toggle the value.

 **NOTE:** Touch [Adjust Daylight Savings](#) if appropriate.

- d. Touch the appropriate time zone button.
- e. Touch [Save](#).

 **NOTE:** To change the date and time format, touch [Date/Time Format](#) on the [Date/Time Settings](#) screen.

3. Configure the sleep timer setting.
 - a. On the [General Settings](#) screen, touch [Energy Settings](#), and then touch [Sleep Timer Settings](#).
 - b. Touch the [Minutes](#) box to select it, and then use the pop-up keypad to set the value in minutes.
 - c. Select the appropriate action for [Wake/Auto On to These Events](#).
 - d. Touch [OK](#), and then touch [Save](#).

 **NOTE:** You can also configure the [Sleep Schedule](#) feature from the [Energy Settings](#) screen.

Assign IP address

If the network uses dynamic host configuration protocol (DHCP), the IP address can be assigned automatically. Otherwise, you must manually assign an IP address.

To use DHCP and assign the IP address automatically, follow these steps:

1. At the product control panel, touch the [Administration](#) button, touch the [Network Settings](#) option, touch the [Embedded Jetdirect Menu](#) option, touch the [TCP/IP](#) option, touch the [IPv4 Settings](#) option, and then touch the [Config Method](#) option.
2. Touch [DHCP](#).
3. Touch [Save](#).

To manually assign an IP address:

1. At the product control panel, touch the [Administration](#) button, touch the [Network Settings](#) option, touch the [Embedded Jetdirect Menu](#) option, touch the [TCP/IP](#) option, touch the [IPv4 Settings](#) option, and then touch the [Config Method](#) option.
2. Touch [Manual](#), and then touch [Save](#).
3. On the IPv4 Settings screen, touch [Manual Settings](#), and then touch [IP Address](#).
4. Touch the first IP address entry field and use the keyboard to enter the first portion of the IP address.
5. Enter the remaining portions of the IP address, and then touch [Save](#).

Set up and configure e-mail settings using the E-mail Setup Wizard

Make sure you have a functioning Internet connection before completing this procedure.

1. At the product control panel, touch the [Administration](#) button, touch the [Scan/Digital Send Settings](#) option, touch the [E-mail Settings](#) option, and then touch [E-mail Setup Wizard](#).



NOTE: You can also use Initial Setup if it is still enabled (touch the [Administration](#) button, touch the [Initial Setup](#) option, and then touch the [E-mail Setup Wizard](#) option).

2. Select an SMTP server option, and then follow the onscreen instructions; touch [Next](#) as you complete each screen in the wizard.
3. Touch **Finish** on the final wizard screen to complete setup and close the wizard.

You can also use the Embedded Web Server (EWS) to set up the address book with LDAP (Lightweight Directory Access Protocol).

1. Click the **Security** tab, click **Access Control**, and then click the **Setup** link for LDAP.
2. Follow the onscreen instructions to set up and configure LDAP.



NOTE: You must select the **Enable LDAP Sign In** checkbox (under **Setup**) to enable this sign-in method.

3. When configuration is complete, click **OK**.

Manually configure IPv4 TCP/IP parameters from the control panel

In addition to using the Embedded Web Server, you can also use the control-panel menus to set an IPv4 address, subnet mask, and default gateway.

1. At the product control panel, touch the [Administration](#) button, touch the [Network Settings](#) menu, touch the [Embedded Jetdirect Menu](#) option, touch the [TCP/IP](#) option, touch the [IPv4 Settings](#) option, and then touch the [Config Method](#) option.
2. Touch [Manual](#), and then touch [Save](#).
3. Touch the Back button to return to the IPv4 Settings screen.
4. On the IPv4 Settings screen, touch [Manual Settings](#), and then touch the option you wish to manually set and follow the onscreen instructions to change the option setting.
5. Touch the Back button repeatedly until you return to the [Embedded Jetdirect Menu](#).

6. Touch the [Link Speed](#) option.
7. Touch one of the following options.

Setting	Description
Auto	The product automatically configures itself for the highest link speed and communication mode allowed on the network.
10T Half	10 megabytes per second (Mbps), half-duplex operation
10T Full	10 Mbps, full-duplex operation
100TX Half	100 Mbps, half-duplex operation
100TX Full	100 Mbps, full-duplex operation
100TX Auto	Limits auto-negotiation to a maximum link speed of 100 Mbps
1000T Full	1000 Mbps, full-duplex operation

8. Touch the [Save](#) button.

Manually configure IPv6 TCP/IP parameters from the control panel

In addition to using the Embedded Web Server, you can also use the control-panel menus to set an IPv6 address.

1. At the product control panel, touch the [Administration](#) button, touch the [Network Settings](#) menu, touch the [Embedded Jetdirect Menu](#) option, touch the [TCP/IP](#) option, touch the [IPv6 Settings](#) option, touch the [Address](#) option, touch the [Manual Settings](#) option, and then touch the [Enable](#) option.
2. Touch the [On](#) option, and then touch the [Save](#) button.
3. Touch the [Address](#) option, and then touch the data entry field.
4. Use the keyboard to enter the address, and then touch the [Save](#) button.

Disable network protocols (optional)

By factory default, all supported network protocols are enabled. Disabling unused protocols has the following benefits:

- Decreases product-generated network traffic
- Provides only pertinent information on the configuration page
- Allows the product control panel to display protocol-specific error and warning messages

Link speed and duplex settings

The link speed and communication mode of the product must match the network. For most situations, leave the product in automatic mode. Incorrect changes to the link speed and duplex settings might prevent the product from communicating with other network devices. If you need to make changes, use the product control panel.

 **NOTE:** Making changes to these settings causes the product to turn off and then on. Make changes only when the product is idle.

1. At the product control panel, touch the [Administration](#) button, touch the [Network Settings](#) menu, and then touch the [Jetdirect Menu](#) option.
2. Touch the down arrow until the [Link Speed](#) option displays.
3. Touch the [Save](#) button. The product turns off and then on.

Basic configuration using the Embedded Web Server

When the product is connected to the network, the Embedded Web Server (EWS) is automatically available.

To start the EWS, open a web browser on a computer and type the IP address of the product. To find the IP address or host name, touch the [Network Address](#) button on the Home screen on the product control panel.

- [View or change network settings](#)
- [Set or change the administrator password](#)
- [Configure e-mail options](#)
- [Save to Network Folder Setup](#)
- [Configure save to SharePoint options](#)
- [Configure USB storage device settings](#)
- [Configure Quick Sets](#)
- [Configure general security settings](#)
- [Configure access control security settings](#)

View or change network settings

You can use the Embedded Web Server to view or change IP configuration settings.

1. Open the Embedded Web Server.
2. Click the **Networking** tab to obtain network information. You can change settings as needed.

Set or change the administrator password

Use the Embedded Web Server to set an administrator password or change an existing password. When set, you must enter this password before you can access and change configuration settings.

1. Open the Embedded Web Server and click the **Networking** tab.
2. In the left-side pane, click the **Authorization** option.

 **NOTE:** If a password has previously been set, you are prompted to type the password. Type the password, and then click the **Apply** button.

3. Type the new password in the **Password** box and in the **Confirm Password** box.
4. At the bottom of the window, click the **Apply** button to save the password.

 **NOTE:** You can also set a local administrator password from the **General Security** option on the **Security** tab. When set, you must enter this password to change settings within the Embedded Web Server.

Configure e-mail options

1. Open the Embedded Web Server.
2. Click the **Scan/Digital Send** tab.
3. In the left navigation pane, click the **E-mail Setup** entry.
4. Select **Enable Send to E-mail** and click **Add**, follow the SMTP wizard to complete the required fields and any additional fields you want, and then click the **Apply** button.

 **TIP:** You must specify an outgoing SMTP server and complete the **From:** field. See the Embedded Web Server Help for more information.

5. To add addresses to the Address book, click the **Address Book** entry in the left navigation pane and then follow the onscreen instructions.

After you have configured the e-mail settings, send an e-mail to yourself by using the digital-send feature. If you receive the e-mail, you have successfully configured the digital-sending feature.

If you do not receive the e-mail, use these actions to resolve issues:

- Check the SMTP and address to make sure that you typed them correctly.
- View the configuration page. Verify that the SMTP gateway address is correct.
- Make sure that the network is operating correctly. Send an e-mail to yourself from a computer. If you receive the e-mail, the network is operating correctly. If you do not receive the e-mail, contact your network administrator or Internet service provider (ISP).

Save to Network Folder Setup

Before configuring network folders, set up shared folders following the instructions for your network operating system.

1. Open the Embedded Web Server.
2. Click the **Scan/Digital Send** tab.
3. On the left navigation menu, click the **Save to Network Folder Setup** entry.
4. Select the **Enable Save to Network Folder** checkbox.

 **NOTE:** If you select **Use credentials of user to connect after Sign In at the control panel** in the **Authentication Settings** drop-down list, the logged-in user must have permissions to write to the specified network folder.

5. Set the default settings you want for all folders and then click the **Apply** button.
6. To specify network folders to which to save documents, click the **Add** button in the **Quick Sets** area and follow the onscreen instructions.

Configure save to SharePoint options

Before you can complete this procedure, the destination folder to which you want to save scanned files must exist on the SharePoint site, and you must have write access to the destination folder.

1. Open the Embedded Web Server.
2. Click the **Scan/Digital Send** tab.
3. On the left navigation menu, click the **Save to SharePoint** entry.
4. Select the **Enable Scan to SharePoint** checkbox, and then click **Add**.
5. On the first screen of the quick set wizard, supply a title and description for the scan-to-SharePoint quick set, select the button location for the quick set and options for user interaction at the control panel, and then click **Next**.
6. On the SharePoint Destination Settings dialog, click **Add** to create a scan-to-SharePoint destination, and then follow the instructions at the top of the SharePoint Destination Settings dialog.
 - a. Using your browser, navigate to the SharePoint scan destination folder, copy the destination path, paste the path into the **SharePoint Path** field on the Add SharePoint Path dialog, and complete the remainder of the dialog fields as desired.



NOTE: If you select **Use credentials of user to connect after Sign In at the control panel** in the **Authentication Settings** drop-down list, the logged-in user must have permissions to write to the specified SharePoint site.

- Make sure to provide a fully-qualified domain name in the **Windows Domain** field (this field is case-sensitive).
 - Make sure to select **Generate Short URL** to remove extraneous characters from the path name.
- b. When you have finished defining the SharePoint settings, click **OK**, and then click **Next**.
 - c. Complete the remainder of the Quick Set Wizard dialogs as appropriate, clicking **Next** to progress to the next dialog.
 - d. When you reach the Summary dialog, click **Finish** to complete setup.

Once you have created a save-to-SharePoint quick set, you can scan to the SharePoint destination using the quick set either directly from the Home screen or from the [Quick Sets](#) button on the Home screen.

Configure USB storage device settings

1. Open the Embedded Web Server.
2. Click the **Scan/Digital Send** tab.
3. On the left navigation menu, click the **Save to USB Setup** entry.
4. Select the **Enable Save to USB** checkbox.
5. Set the default settings you want.
6. Click the **Apply** button.

Configure Quick Sets

1. Open the Embedded Web Server.
2. Click the **General** tab.
3. On the left navigation menu, click the **Quick Sets Setup** entry.
4. Click the **Add** button, and then follow the onscreen instructions in the Quick Set Wizard.
5. When you are done, click the **Apply** button.



TIP: You can also configure Quick Sets on other setup pages in the Embedded Web Server.

Configure general security settings

1. Open the Embedded Web Server.
2. Click the **Security** tab, and then click **General Security**.
3. Type a new password and then type the password again to verify.
4. Select **Enable Host USB plug and play** if you wish to enable the covered USB port on the front of the product.
5. Click **Apply**.

Configure access control security settings

Completing each step may take you to multiple screens.

1. Open the Embedded Web Server.
2. Specify and configure the security method to be used (LDAP or Windows).
 - a. Click the **Security** tab, and then click **Access Control**.
 - b. Under **Enable and Configure Sign In Methods**, click **Setup** to configure the desired sign-in method (LDAP or Windows).
 - c. Follow the onscreen instructions on the selected sign-in method setup screen; when setup is complete, click **OK**.
3. Under **Sign In and Permission Policies** on the Access Control screen, set device feature access settings for each level of user, and then select a **Manage Permission Sets...** option.
4. Under **Relationships Between Network Users or Groups and Device Permissions**, select the default permission set for each type of sign in method.
5. (Optional): Under **Device User Accounts**, set up individual user accounts if you are not using users and groups to grant device access.

6. When all access control security settings are complete, click **Apply**.
7. Select a file erase mode for erasing temporary job files.
 - a. Click the **Security** tab, and then click **Protect Stored Data**.
 - b. Under **Managing Temporary Job Files**, select the method for erasing temporary job files, and then click **Apply**.
1. Open the Embedded Web Server.
2. Click the **Security** tab, and then click **General Security**.
3. Type a new password and then type the password again to verify.
4. Select **Enable Host USB plug and play** if you wish to enable the covered USB port on the front of the product.
5. Click **Apply**.

Additional configuration using the Embedded Web Server

The following table identifies configuration options available from the Embedded Web Server (EWS). For information about specific options, see the EWS Help.

Table 3-7 Embedded Web Server configuration options

EWS tab	Options
Scan/Digital Send	Address Book, E-mail Setup, Save to Network Folder Setup, Save to USB Setup, OXPd: Workflow, Digital Sending Software Setup
Fax	Fax Send Setup, Speed Dials
Networking	<ul style="list-style-type: none"> • Configuration (TCP/IP Settings, Network Settings, Select Language) • Security (Settings, Authorization, Management Protocols, 802.1X Authentication, IP/Sec Firewall) • Diagnostics (Network Statistics, Protocol Info, Configuration Page)

4 Administration - Manage the product

This section presents information about how to care for and maintain the product.

- [Use information pages](#)
- [Use the Embedded Web Server](#)
- [Use HP Web Jetadmin software](#)
- [Controlling digital-sending security](#)
- [Security features](#)
- [Energy settings](#)
- [Upgrade the firmware](#)
- [Backup product data](#)
- [Restore product data](#)

Occasional cleaning of the product helps ensure high-quality scans. The amount of care necessary depends upon several factors, including the amount of use and the environment. You should perform routine cleaning as necessary.

⚠ CAUTION: Before placing an item in the document feeder, make sure that the item does not contain wet glue, correction fluid, or other substances that can be transferred to the interior of the product.

Make sure there are no curls, wrinkles, staples, paper clips, or any other attached material. Sheets should not be stuck together.

Use information pages

1. From the Home screen, touch the [Administration](#) button and then touch the [Reports](#) option to view pages that give details about the device and its current configuration and status.
 2. Touch the information page option you want to see, and then touch [View](#).
- [Configuration/Status Pages](#)
 - [Administration Menu Map](#)
 - [Current Settings Page](#)
 - [Configuration Page](#)
 - [File Directory Page](#)

- [Web Services Status Page](#)
- [Usage Page](#)
- [Fax Reports](#)
 - [Speed Dial List](#)

Use the Embedded Web Server

When the HP Digital Sender Flow 8500 fn1 is connected to a network, you can use the Embedded Web Server to view status information, change settings, and manage the product from your computer.

To use the Embedded Web Server, you must have Microsoft Internet Explorer 5.01 or later or Netscape 6.2 or later for Windows, Mac OS, and Linux (Netscape only). Netscape Navigator 4.7 is required for HP-UX 10 and HP-UX 11.

The Embedded Web Server works when the product is connected to an IP-based network. You do not have to have Internet access to open and use the Embedded Web Server.

When the product is connected to the network, the Embedded Web Server is automatically available.

 **NOTE:** Some Embedded Web Server options are only available to the network administrator, and some settings might require a password.

You can use the Embedded Web Server without being connected to the Internet; however, some features will not be available.

- [Open the Embedded Web Server](#)
- [Embedded Web Server options](#)

Open the Embedded Web Server

1. In a supported Web browser on your computer, type the product IP address or host name in the address/URL field. To find the IP address or host name, touch the [Network Address](#) button on the Home screen.

 **NOTE:** After you open the URL, you can bookmark it so that you can return to it quickly in the future.

2. The Embedded Web Server has seven tabs that contain settings and information about the product: **Information**, **General**, **Scan/Digital Send**, **Fax**, **Troubleshooting**, **Security**, and **Networking**. Click the tab that you want to view.

Embedded Web Server options

The following table describes the types of information you can obtain or tasks you can perform using the Embedded Web Server tabs. The options that appear on each tab can change when you upgrade firmware, so refer to the Embedded Web Server Help for detailed information about tabs and their options.

 **NOTE:** Each tab also provides links to the **HP Instant Support** and **Product Support** websites.

Tab	Options
Information	The Information tab provides access to information about the product's operational status, configuration settings, event logs, and usage statistics.
General	<p>The General tab provides access to the control panel Administration menu. Options on this tab also allow you to sign up to receive e-mail alerts and configuration and supplies usage information, record device information, set language and date and time options, and more.</p> <p>NOTE: The General tab can be password-protected. If this product is on a network, always consult with the system administrator before changing settings on this tab.</p>
Scan/Digital Send	<p>The Scan/Digital Send tab allows you to set up and configure e-mail, save-to-USB, save-to-network-folder, and digital-sending-software options, populate an address book, and connect to workflow services.</p> <p>NOTE: If the product is configured to use the optional HP Digital Sending Software, the options on these tabs are not available. Instead, all digital-sending configuration is performed by using the HP Digital Sending Software.</p>
Fax	The Fax tab allows you to set up and configure fax sending and speed dial options.
Troubleshooting	<p>The Troubleshooting tab allows you access device reports and logs, locate and install new firmware, and restore device settings to factory defaults.</p> <p>NOTE: Upgrading firmware requires that an administrator password be set in the General Security area of the Security tab.</p>
Security	The Security tab allows you to configure general security, access control, and stored data protection options, as well as to manage certificates.
Networking	<p>The Networking tab allows you to change network settings from your computer when both the product and your computer are connected to an IP-based network.</p> <p>NOTE: The Networking tab can be password-protected.</p>

Use HP Web Jetadmin software

HP Web Jetadmin is a Web-based software solution for remotely installing, monitoring, and troubleshooting network-connected peripherals. Management is proactive, allowing network administrators the ability to resolve issues before users are affected. Download this free, enhanced-management software at www.hp.com/go/webjetadmin.

Plug-ins can be installed into HP Web Jetadmin to provide support for specific product features. The HP Web Jetadmin software can automatically notify you when new plug-ins are available. On the **Product Update** page, follow the directions to automatically connect to the HP Web site and install the latest device plug-ins for your product.

 **NOTE:** Browsers must be Java™-enabled.

Controlling digital-sending security

The product has been designed with security in mind. It includes a variety of features that work to protect the security of the digital-sending process.

Network authentication

The product's most basic security feature is its ability to require a network login before a user can use the digital-sending functions. This prevents unauthorized users from walking up to the product and sending documents. Additionally, the product supports several authentication methods that offer a high level of encryption and security.

Secure e-mail

In addition to the secure email option on this scanner, a number of third-party software vendors offer services for secure e-mail delivery. The [Secondary e-mail](#) feature is designed to work with one of these third-party software programs for users that require an extra measure of data security.

Restrict software access

In order to keep the product secure, you must also restrict access to the software programs that can be used to configure the product.

You can also set a local administrator password using the **General Security** option on the **Security** tab in the Embedded Web Server (EWS) to prevent access to the device-settings tabs. After the password has been set, users can only see the EWS **Information** tab.

Security features

The following security features are available on this product.

- [Secure the Embedded Web Server](#)
- [Manage temporary job files](#)
- [Secure Storage Erase](#)
- [Secure File Erase](#)
- [Secure Disk Erase](#)
- [HP High-Performance Secure Hard Disks](#)
- [Manage certificates](#)
- [Authentication and authorization](#)

Secure the Embedded Web Server

Assign a password for access to the Embedded Web Server so that unauthorized users cannot change the product settings.

1. Open the Embedded Web Server.
2. Click the **Security** tab.
3. On the left side of the window, click the **General Security** link.

4. Type the password in the **New Password** box, and type it again in the **Verify Password** box.
5. Click the **Apply** button. Make note of the password and store it in a safe place.

Manage temporary job files

To specify how your product manages temporary job files that are created when scans are initiated, follow these steps.

1. In the Embedded Web Server, click the **Security** tab, and then click the **Protect Stored Data** link.
2. Under **Managing Temporary Job Files**, select a file erase mode.
 - **Non-Secure Fast Erase.** This is a simple file-table erase function. Access to the file is removed, but actual data is retained on the disk until it is overwritten by subsequent data-storage operations. This is the fastest mode. Non-Secure Fast Erase is the default erase mode.
 - **Secure Fast Erase.** Access to the file is removed, and the data is overwritten with a fixed identical character pattern. This is slower than Non-Secure Fast Erase, but all data is overwritten. Secure Fast Erase meets the U.S. Department of Defense 5220-22.M requirements for the clearing of disk media.
 - **Secure Sanitize Erase.** This level is similar to the Secure Fast Erase mode. In addition, data is repetitively overwritten by using an algorithm that prevents any residual data persistence. This mode will impact performance. Secure Sanitize Erase meets standards for clearing disk media defined in NIST Special Publication 800-88 Guidelines for Media Sanitation and the U.S. Department of Defense Updated DSS Clearing and Sanitization Matrix.
3. Click **Apply**.

Secure Storage Erase

Use the **Secure Storage Erase** option in the Embedded Web Server to protect deleted data from unauthorized access on the product hard drive. The **Secure Storage Erase** option provides two secure erase types, both of which meet the U.S. NIST Special Publication 800–88 guidelines for media sanitization.

1. In the Embedded Web Server, click the **Security** tab, click the **Protect Stored Data** option, and then click the **Erase Options** button.
2. Select a storage erase option.
 - **Secure Fast Erase.** Access to the file is removed, and the data is overwritten one time with a fixed identical character pattern.
 - **Secure Sanitize Erase.** This level is similar to **Secure Fast Erase** but data is overwritten three times. This will impact performance.
3. Click the **Erase** button.

Data affected

Data affected (covered) by the **Secure Storage Erase** feature includes stored fax files, stored jobs, and HP and third-party application data.

This feature will not impact data that is stored on flash-based product non-volatile RAM (NVRAM) that is used to store default settings, page counts, and similar data. This feature does not affect data that is stored on a system RAM disk (if one is used). This feature does not impact data that is stored on the flash-based system boot RAM.

Secure File Erase

Changing the **Secure File Erase** mode does not overwrite previous data on the disk, nor does it immediately perform a full-disk sanitization. Changing the **Secure File Erase** mode changes how the product cleans up temporary data for jobs after the erase mode has been changed.

Secure Disk Erase

[Secure Disk Erase](#) permanently erases all the data on the hard drive. If you have an encrypted hard drive, this function also unlocks the encrypted hard drive, thereby allowing the drive to be read by any device.

⚠ WARNING! Only use this option at product end-of-life. Since [Secure Disk Erase](#) permanently erases all data (including the product operating system), the product will not boot up.

You can access the [Secure Disk Erase](#) feature from the product's Administrative Tools option on the Boot menu. To access the Boot menu, press the Power button to turn off the product, press and hold the Escape key on the keyboard, and then press the Power button to turn on the product while continuing to hold the Escape key until the Boot menu displays.

HP High-Performance Secure Hard Disks

This product supports an encrypted hard disk that might be installed in the EIO slot, on the formatter board, or in both locations. The only encrypted hard disk that is supported is the disk that comes bundled with the product. Encrypted hard disks provide hardware-based encryption so you can securely store sensitive scan data without impacting product performance. Encrypted hard disks use the latest Advanced Encryption Standard (AES) and have versatile time-saving features and robust functionality.

Manage certificates

The product has a built-in self-signed certificate, which allows for encryption and a reasonable level of trust for network communications with entities such as the LDAP server (communication that can include user names and passwords). However, some networks require trusted certificates. In these cases, you might be required to install a certificate from the network certificate authority.

The certificate manager also allows you to load certificate revocation lists (CRL).

Load a certificate

1. From a Web browser, open the Embedded Web Server by typing the IP address of the product.
2. On the main Embedded Web Server page, click the **Security** tab, and then select the **Certificate Management** entry.



NOTE: If the **Certificate Management** page is unavailable, update the product firmware.

3. Under **Install Certificate**, click **Browse...** to locate the certificate you want to load.



NOTE: Find certificates at the location where a network administrator created them. If the certificate you select is password-protected, you will need to enter the certificate password.

4. Click **Import** to import the certificate. The certificate will appear in the certificates list after it is loaded.

Load a certificate revocation list (CRL)

1. From a Web browser, open the Embedded Web Server by typing the IP address of the product.
2. On the main EWS page, click the **Security** entry, and then select the **Certificate Management** entry.



NOTE: If the Certificate Management page is unavailable, update the product firmware.

3. Under **Install Certificate**, click **Browse...** to locate the CRL to load.
4. Click **Import** to import the CRL. The CRL will appear in the certificate revocation list after it is loaded.

Authentication and authorization

You can secure access to various parts of the control panel menu by establishing passwords. These passwords can be created to be local to the product, or can be obtained from the network by configuring Windows or LDAP server information.

To configure these settings using the Embedded Web Server, follow these steps.

1. In the Embedded Web Server, click the **Security** tab, and then click the **Access Control** link.
2. Configure access control options.
 - **Enable and Configure Sign In Methods.** This section allows the administrator to configure the Windows or LDAP network settings. The product uses these settings to obtain user information from the server.
 - **Sign In and Permission Policies.** This section allows the administrator to manage product permissions. By default, the product will support Guest, Administrator, and User permission sets. The administrator can add permission sets, and can configure which sign-in method to use on control panel applications.

- **Relationships Between Network Users or Groups and Device Permissions.** This section allows the administrator to select the default permission set for Windows and LDAP sign-in methods.
- **Device User Accounts.** This section allows the administrator to establish user access codes.

Energy settings

To manage the product's energy settings using the Embedded Web Server, follow these steps:

1. Start the Embedded Web Server.
2. Click the **General** tab, and then select **Energy Settings**.
3. Under **Sleep Schedule**, click **Add** to open the Sleep Schedule window.
 - a. Follow the onscreen instructions to define a weekly or holiday sleep schedule event.
 - b. Click **Apply** to save the sleep schedule event.
4. Under **Sleep Timer Settings** on the **Energy Settings** dialog, click [Sleep Mode/Auto Off After](#), enter the number of minutes of activity after which you want the scanner to enter Sleep Mode, and then click **Apply**

 **NOTE:** You can also configure energy settings from the control panel Home screen. Touch [Administration](#), touch [General Settings](#), and then touch [Energy Settings](#).

Upgrade the firmware

 **NOTE:** You must have access to the product's local administrator password to complete this task.

1. From the Home screen, touch the [Administration](#) button, touch the [Reports](#) button, and then touch the [Configuration/Status Pages](#) button.

 **NOTE:** Check the [Configuration Page](#) option; the report lists the current firmware revision number.

2. See www.hp.com/support, search for your product, and then look for a link to downloads to see if there is a newer version of firmware available.
3. Copy the new firmware file to a USB storage device, and then plug the USB device into the USB connector beside the control panel.

 **CAUTION:** Make sure to leave the USB storage device plugged into the USB connector until all upgrades are installed, the product has rebooted, and the Home screen is displayed on the touch screen.

4. From the Home screen, touch the [Device Maintenance](#) button, and then touch the [USB Firmware Upgrade](#) button.

5. Touch [Firmware Upgrade Bundle](#), and then touch the [Upgrade](#) button.

The upgrade process can take a few minutes.

6. When prompted, touch the [Yes](#) button to reboot the product.

Starting the product after a firmware upgrade may take up to 20 minutes.

7. If necessary, repeat the previous two steps to install a second upgrade.

 **NOTE:** You can also upgrade firmware using the Embedded Web Server. Start the Embedded Web Server, click the **General** tab, click **Firmware Upgrade** in the left navigation pane, and then follow the onscreen instructions to download a firmware upgrade directly to your product.

Backup product data

HP recommends doing routine, scheduled backups as a best practice.

To backup data stored on the product, follow these steps:

1. Start the Embedded Web Server (EWS).
2. Click the **General** tab, and then select **Backup and Restore**.
3. Under **Backup/Restore**, select **Backup**, and then supply the UNC folder path to which the backup file will be stored.

 **NOTE:** If the backup folder is encrypted, you must enter the encryption key in the **Encryption Key** field under **Authentication Settings**.

4. Under **Authentication Settings**, enter the Windows domain, username, and password, and then click **OK** to create the backup file.

A progress meter indicates the status of the backup operation.

 **NOTE:** You can also backup data from the control panel Home screen. Touch [Device Maintenance](#), touch [Backup/Restore](#), and then touch [Backup Data](#).

Restore product data

To restore backed-up product data, follow these steps:

1. Start the Embedded Web Server (EWS).
2. Click the **General** tab, and then select **Backup and Restore**.
3. Under **Backup/Restore**, select **Restore**, and then supply the full pathname to the file which you wish to restore.

 **NOTE:** If the backup folder is encrypted, you must enter the encryption key in the **Encryption Key** field under **Authentication Settings**.

4. Under **Authentication Settings**, enter the Windows domain, username, and password, and then click **OK** to restore the backup file.

A progress meter indicates the status of the restore operation. The product automatically restarts when the restore operation is complete.

 **NOTE:** You can also restore backed-up data from the control panel Home screen. Touch [Device Maintenance](#), touch [Backup/Restore](#), and then touch [Restore Data](#).

5 Load originals

- [Use the automatic document feeder \(ADF\)](#)
- [Use the scanning glass](#)

Use the automatic document feeder (ADF)

For helpful information on loading your documents properly, refer to the following topics.









- [Document loading tips](#)
- [Document loading tips for mixed-size documents](#)
- [How to load documents](#)





Document loading tips

- The maximum capacity of the document feeder and output tray varies by paper size and weight. For 75g/m² (20 lb) paper (the standard weight for most printer and photocopier paper), the maximum capacity is 100 sheets. For heavier paper, the maximum capacity is less.
- The automatic document feeder (ADF) supports the following paper types.

	Width	Length	Weight (or thickness)
Standard stock (single page)	68-216 mm (2.7-8.5 in)	148-864 mm (5.8-34 in)	49-120 g/m ² (13-32 lbs)
Standard stock (multiple pages)	68-216 mm (2.7-8.5 in)	148-356 mm (5.8-14 in)	49-120 g/m ² (13-32 lbs)

- Scanning the following types of documents with the ADF might result in paper jams or damage to the documents. To scan these documents, use the scanning glass instead of the ADF.

	Wrinkled or creased documents		Curled documents
	Torn documents		Documents with paper clips or staples
	Carbon paper		Coated paper
	Extremely thin, translucent paper		Paper with adhesive notes or flags attached

	Photos		Overhead transparencies
	Papers that are stuck together		Paper with wet substances such as glue or correction fluid

- Smooth out any folds or curls in your documents before placing them into the feeder. If the leading edge of a document is curled or folded, it may cause a paper jam.
- When loading paper that is smaller than 148 mm (5.8 in) in width, place the long edge of the page parallel to the paper guides.
- To scan fragile documents (such as photos or documents on wrinkled or very lightweight paper), place the document face down on the scanning glass.
- Make sure that the hatch on the document feeder is securely latched. To properly close the hatch, press until you hear a click.
- Adjust the paper guides to the width of the documents. Make sure that the paper guides touch the edges of the original. If there is any clearance between the paper guides and the edges of the documents, the scanned image might be skewed.
- When placing a stack of documents into the feeder, gently set the stack in the document feeder. Do not drop the stack into the feeder.

 **TIP:** The document load/detect LED on the clear portion of the document feeder input tray is on when documents are positioned correctly.

- To prevent skewing, always load stacks of documents of the same dimensions. However, if you must load stacks of mixed document sizes, center all documents in the stack by width before inserting them in the document feeder.
- Clean the scanning rollers if the rollers are visibly dirty or after scanning a document that has pencil writing on it.

Document loading tips for mixed-size documents

You can load the document feeder with groups of documents that have different widths or lengths. If your document contains different sized pages, you can scan it as described below.

- If your documents have the same width but different lengths (legal and letter size, for example), you can scan them as a single job. The scanned items will have the same length as the original items in the document.
- If you want to prevent skewing and ensure that each scanned item has the same width and length as the original, use the **Job Build** feature. Each segment of the job build must have documents of the same width and length.

How to load documents

1. Adjust the paper guides to the width of the documents. Take care not to overtighten the guides, which can restrict paper feeding.



When scanning small originals such as checks, it is especially important that the paper guides fit snugly against the edges of the original.

2. Fan the stack of document pages to ensure that the pages do not stick together. Fan the edge that will be pointing into the feeder in one direction, and then fan that same edge in the opposite direction.



3. Align the edges of the documents by tapping the bottom of the stack against the table top. Rotate the stack 90 degrees and repeat.

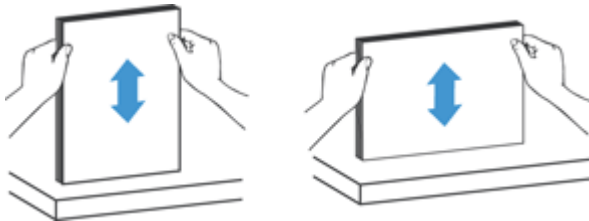

4. Gently set the stack in the document feeder. Load the pages face up with the top of the pages pointing into the feeder.

For best results, do not drop the stack into the feeder and do not tap the top edge of the stack after you have placed it in the document feeder.



TIP: Avoid feeding a document with a leading edge that has been folded or frayed. When you begin scanning, select a profile whose page loading selection matches the edge you are feeding first to ensure that the scan reflects the orientation of the original document.

5. Verify that the paper guides are aligned with the edges of the stack.

Use the scanning glass

Place items that do not meet the specifications for the automatic document feeder (ADF) directly onto the scanning glass.

Minimum size:	No minimum size
Maximum size:	216 x 356 mm (8.5 x 14 in)

NOTE: Not all the length of the scanning glass is in the active imaging area, so make sure to position your originals as indicated by the reference mark on the edge of the scanning glass.

Place the original face down on the scanning glass, as indicated by the reference mark. For landscape pages, place the page face down with the top of the page pointing toward the back of the product.



 **TIP:** To scan multiple pictures at the same time, arrange the pictures that you want to scan on the scanning glass with at least 6 mm (0.25 in) of space between items.

6 Scan and send documents

- [Sign in](#)
- [New scanner features](#)
- [Preview a scan](#)
- [Send a scanned document to one or more e-mails](#)
- [Fax a scanned document](#)
- [Save to a network folder or USB storage device](#)
- [Save to a SharePoint site](#)
- [Send or save a document using Quick Sets](#)
- [Scan to a workflow destination](#)

Sign in

Depending on how your administrator has configured access privileges, you might need to sign in before using the product as well as when you access product features. The access your administrator has set for you might limit the features available to you.

1. Touch the [Sign In](#) button.
2. Complete the required fields, and then touch the [OK](#) button.

New scanner features

- **Automatically Straighten (auto-deskew):** Use this feature to automatically straighten the scanned image when pages are skewed during scanning.
- **Automatic Tone**
- **Cropping Options:** Use this feature to specify a method to automatically crop the scan for digital sending.
 - **Do not crop** does not crop the scan.
 - **Crop to paper** crops the scan to the edge of the document being scanned through the automatic document feeder, based on the specified original document size.
 - **Crop to content** crops the image to the smallest possible rectangular area that has detectable content.
- **Edge Erase:** Use this feature to remove blemishes (such as dark borders or staple marks) by cleaning the specified edges of the scanned images to the specified measurement.

- **Job Build:** Use this feature to divide a complex job into smaller segments (for example, when scanning a document that has more pages than the document feeder can hold, or when scanning pages of different sizes in one job).
- **Retrieve from USB:** Use this feature to retrieve the following file types from an inserted USB device: .PDF, .PRN, .PCL, .PS, CHT.
- **Send document to a network printer:** Use this feature to send the output file to a specified network printer.
- **Scan document to a SharePoint site:** Use this feature to send the output file to a SharePoint destination.

Preview a scan

Use the touch screen to navigate through the options on the Image Preview screen.



1	Home button	Touch this button to open the Home screen.
2	Start button	Touch this button to scan the document and send it to the specified destination.
3	Help button	Touch this button for control-panel help.
4	Cancel Job button	Touch this button to cancel your changes and return to previous screen.
5	Page control field	Type a number to view a page.
6	Zoom button	Touch this button to view the preview magnified.
7	View button	Touch this button to switch between single and multi-page views and to access more options.
8	Append Pages button	Touch this button to append a newly scanned document to the end of the document in the preview.
9	Move Pages button	Touch this button to move a selected page or pages.
10	Rotate Pages button	Touch this button to rotate the scan clockwise in increments of 90 degrees.
11	Delete Pages button	Touch this button to delete a selected page or pages.

Use the Image Preview screen

You can preview a document and adjust certain document job options before sending the scan. The Image Preview screen is available for all scan destinations, but not all document job options are available for all scan destinations.

1. From a scan screen, touch the [Preview](#) button.
2. To increase the magnification for viewing purposes only, touch the Zoom button. Touch it again to return to the original magnification. To view parts of the zoomed page that might be off the screen, place your finger on the image and drag.
3. To see a multi-page view of the scanned document and move, append, delete, or rotate pages, touch the View button.
4. When you are done making changes, touch the Start button to save your changes and send the scan or the [Cancel Job](#) button to cancel your changes and return to the previous screen.

Append pages

1. From the Image Preview screen, touch the View button.
2. Touch the Append Pages button.
3. In the [Append New Pages](#) dialog box, touch the [Scan](#) button. The pages are appended to the end of the document.

Move pages

1. From the Image Preview screen, touch the View button.
2. Touch the pages you want to move. To deselect a page, touch it again. To select contiguous pages, touch the first and last pages of the group you want.
3. Touch the Move Pages button.
4. Touch the Insert icon where you want to move the pages.

Rotate pages

1. From the Image Preview screen, touch the View button.
2. Touch the pages you want to rotate. To deselect a page, touch it again. To select contiguous pages, touch the first and last pages of the group you want.
3. Touch the Rotate Pages button. The page rotates clockwise in 90-degree increments with each touch.

Delete pages

1. From the Image Preview screen, touch the View button.
2. Touch the pages you want to delete. To deselect a page, touch it again.
3. Touch the Delete Pages button.

Send a scanned document to one or more e-mails

The e-mail feature offers the following benefits:

- Sends documents to multiple e-mail addresses, saving time and delivery costs.
- Delivers files in black-and-white or in color. Files can be sent in different file formats that the recipient can manipulate.

In order to use the e-mail feature, the product needs to be connected to a valid SMTP local area network that includes Internet access.

Use the address book

You can send e-mail to a list of recipients using the address book feature. See your system administrator for information about configuring address lists.



NOTE: You can also use the Embedded Web Server (EWS) to create and manage the address book. The EWS address book can be used to add, edit, or delete single addresses or distribution lists.

Create a recipient list

1. From the Home screen, touch the [E-mail](#) button.
2. Touch the [To:](#) field and then type the recipients' e-mail addresses. Separate multiple entries with a semicolon or by pressing enter on the keyboard.



TIP: You can also use the address book to enter e-mail addresses. For more information, see the built-in Help.

3. The names in the recipient list are placed in the text line of the keyboard screen. To add a recipient that is not found in the address book, type the e-mail address.
4. Touch the [OK](#) button.
5. Finish typing information in the [cc:](#), [bcc:](#), [Subject:](#), and [Message:](#) fields on the [Send E-mail](#) screen, if necessary. To check the list of recipients, touch the down arrow in the [To:](#) text line.
6. Touch the Start button.

Use the Personal or Shared Contacts address book

Use the Personal or Shared Contacts address book to store frequently-used e-mail addresses and to insert them into the [From:](#), [To:](#), [cc:](#), or [bcc:](#) fields.

To open an address book, touch the Address Book button , and then select the appropriate contact entry.

Add entries to the Personal or Shared Contacts address books

1. Touch the add button **+**.
2. Touch the **Name** field, and type a name for the new entry.
The name is the alias for the entry.
3. Type the e-mail address for the new entry, complete any additional optional fields, and then touch the **OK** button.

Delete entries from the Personal Contacts address book

You can delete entries that you no longer use.

 **NOTE:** To change an entry, highlight the text you want to change, and then type the new text.

1. Touch the entry that you want to delete from the Personal Contacts address book.
2. Touch the Remove button  in the lower right corner.
3. In the confirmation dialog box that appears, touch the **Delete** button to delete the entry or touch the **Cancel** button to return to the Address Book screen.

Use the Send E-mail screen

Use the touch screen to navigate through the options on the **E-mail** screen.

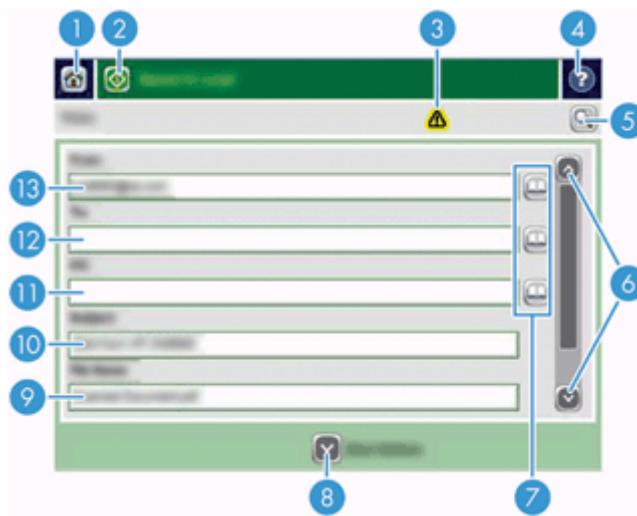

1	Home button	Touch this button to open the Home screen.
2	Send E-mail button	Touch this button to scan the document and send an e-mail file to the specified e-mail addresses.
3	Error/warning button	This button appears only when there is an error or warning in the status line area. Touch it to open a pop-up screen that will help you resolve the error or warning.
4	Help button	Touch this button for control-panel help.
5	Preview button	Touch this button to display a preview that you can modify before sending the scanned document.

6	Scroll bar	Use the Scroll bar to view and set up the cc: , bcc: , Message: , and File Name: fields. Touch any of those fields and add the necessary information.
7	Address book buttons	Touch these buttons to use the address book to populate the To: , cc: , or bcc: fields.
8	More Options button	Touch this button to change certain e-mail settings for the current scan job.
9	File Name: field	Touch this field and then type the name of the scanned document.
10	Subject: field	Touch this field and then type a subject title.
11	cc: field	Touch this field and then type the e-mail addresses of those secondary individuals whom you want to receive the scanned document.
12	To: field	Touch this field and then type the e-mail addresses of those primary individuals whom you want to receive the scanned document.
13	From: field	Touch this field and then type your e-mail address. If the system administrator has configured the product to do so, this field might automatically insert a default address.

Send documents

The product scans both black-and-white and color originals. You can use default settings or change the scanning preferences and file formats.

 **TIP:** You can perform these tasks for a single-page document by placing the document face-down on the scanner glass.

Send a document

1. Place the document face up in the document feeder.
2. From the Home screen, touch the **E-mail** button.
3. If prompted, type your user name and password.
4. Complete the **From:** and **To:** fields. Scroll down and complete the **cc:**, **bcc:**, and **Message:** fields if appropriate. Your user name or other default information might appear in the **From:** field. If so, you might not be able to change it.
5. (Optional) Touch the **More Options** button to change the settings for the document that you are sending (for example, the document's original size). If you are sending a two-sided document, you should select **Sides** and an option with a two-sided original. For information about other available features, see the built-in Help.
6. Touch the Start button to begin sending.
7. When you are finished, remove the original document from the output tray.

Use the auto-complete function

When you type characters into the **To:**, **cc:**, or **From:** fields on the **Send E-mail** screen, the auto-complete function is activated. As you type the required address or name, the product automatically searches the address book list and completes the address or name by using the first match. You can then select that name by pressing enter on the keyboard, or continue typing the name until auto-complete finds the

correct entry. If you type a character that does not match any entry in the list, the auto-complete text is removed from the display to indicate that you are typing an address that is not in the address book.

Fax a scanned document

Use the Send Fax screen

Use the touch screen to navigate through the options on the [Send Fax](#) screen.

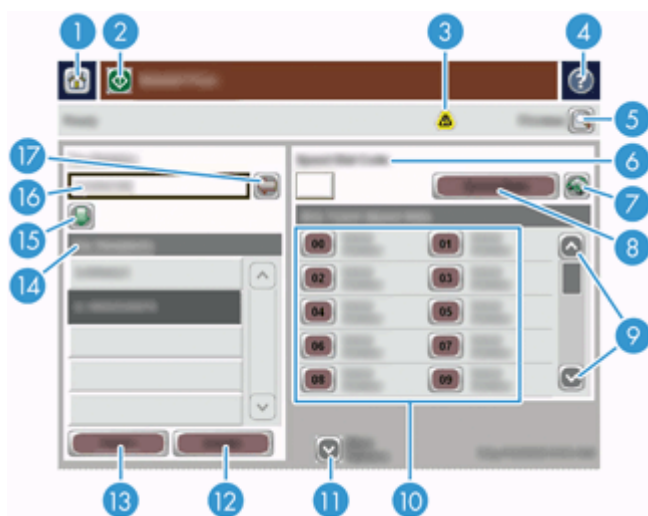

1	Home button	Touch this button to open the Home screen.
2	Send Fax button	Touch this button to scan the document and send a fax to the provided fax numbers.
3	Error/warning button	This button appears only when there is an error or warning in the status line area. Touch it to open a pop-up screen that will help you resolve the error or warning.
4	Help button	Touch this button for control-panel Help.
5	Preview button	Touch this button to display a preview that you can modify before faxing the scanned document.
6	Speed Dial Code field	Touch this button to type a speed dial code directly.
7	Search button	Touch this button to search for a speed dial code by name.
8	Speed Dials button	Touch this button to edit the speed dial.
9	Scroll bars	Use the scroll bar to view more entries.
10	One Touch Speed Dials list	Touch a button in this area to add the fax number to the Fax Recipients list.
11	More Options button	Touch this button to change certain fax settings for the current scan job.
12	Details button	Touch this button to display more information about the fax number highlighted in the Fax Recipients list.
13	Delete button	Touch this button to remove the highlighted fax number from the Fax Recipients list.
14	Fax Recipients list	Lists the numbers you have selected to receive the scanned document.

15	Add fax number button	Touch this button to add the fax number in the Fax Number: field to the Fax Recipients list.
16	Fax Number: field	Touch this field and then type a fax number.
17	Delete character button	Touch this button to backspace and delete numbers in the Fax Number: field.

Send a fax

1. Place the document face up in the document feeder.
2. From the Home screen, touch the [Fax](#) button.
3. If prompted, type your user name and password.
4. Specify the fax numbers by using one or both of these methods:

Use the [Fax Number:](#) field Type the fax number.

(Optional) Type additional fax numbers separated by semi-colons.

Use a speed dial From the [Send Fax](#) screen, touch the code in the [One Touch Speed Dials](#) list.

5. (Optional) Touch the [More Options](#) button to change the settings for the document that you are sending. For information about available features, see the built-in Help.
6. Touch the Start button to begin sending.

Save to a network folder or USB storage device

If the system administrator has made the feature available, the product can scan a file and save it to either a USB storage device or a network folder. Supported operating systems for folder destinations include Windows 2000, Windows XP, Windows Server 2003, and Windows Server 2008.

1. Place the document face up in the document feeder.
2. If you are saving to a USB storage device, insert it into the USB connector next to the control panel.
3. On the Home screen, touch either the [Save to Network Folder](#) or the [Save to USB](#) button.
4. In the folders list, touch the folder in which you want to save the document.
5. Select a quick set or touch the [File Name:](#) field, and then type the name of the file.
6. Touch the [More Options](#) button to change the settings for the document you are sending.
7. Touch the Start button.



NOTE: The additional options are the same as the e-mail options.

Save to a SharePoint site

If the system administrator has made the feature available, the product can scan a document and save the file to a SharePoint site.

1. Place the document face up in the document feeder.
2. On the Home screen, touch the **Save to SharePoint** button.
3. Select an existing SharePoint quick set.

 **TIP:** A SharePoint quick set is either accessible directly from the Home screen, or from the **Quick Sets** button on the Home screen, depending on how the save-to-SharePoint option was defined.

4. If prompted, type your user name and password.
5. If necessary, press the **Start** button on the control panel to start the scan.

 **NOTE:** It is possible to configure a scan-to-SharePoint quick set to start automatically when the SharePoint option is selected.

Send or save a document using Quick Sets

If the system administrator has made the feature available, the product can scan a file using preset settings for fax numbers, e-mail recipients, network folders, or USB storage devices.

Depending on how your administrator has configured [Quick Sets](#), you can also touch the [Quick Sets](#) button on the Home screen to display a list of available [Quick Sets](#).

1. Place the document face up in the document feeder.
2. From the Home screen, touch a [Quick Sets](#) button. Those [Quick Sets](#) buttons that have a small Start icon on them start scanning when you touch them.
3. If prompted, type your user name and password.
4. If a screen for sending the scanned document to e-mail, fax, or a network folder displays, complete the fields, and then touch the Start button.

Scan to a workflow destination

 **NOTE:** This product feature is provided by the optional Digital Sending Software.

If the system administrator has enabled the workflow functionality, you can scan a document and send it to a custom workflow destination. A workflow destination gives you the ability to send additional information, along with the scanned document, to a specified network or file transfer protocol (FTP) location. Prompts for specific information appear on the control-panel display. The system administrator can also designate a printer as a workflow destination, which allows you to scan a document and then send it directly to a network printer for printing.

1. Place the document face up in the document feeder.
2. From the Home screen, touch a workflow button.

3. Complete the fields. The fields vary based on how your administrator has configured the workflow.
4. Touch the Start button.

7 Maintain the product

This section presents information about how to maintain the product.

- [Order maintenance and scanning supplies](#)
- [Clean the touch screen](#)
- [Clean the scanning glass, scanning strip, and automatic document feeder \(ADF\) duplex background](#)
- [Clean the rollers](#)

Order maintenance and scanning supplies

You can purchase maintenance parts for your product.

1. See the HP product parts Web site at www.hp.com/buy/parts.
2. Select your language, and then click the arrow.

Clean the touch screen

Clean the touch screen whenever it is necessary to remove fingerprints or dust. Wipe the touch screen gently with a clean, water-dampened, lint-free cloth.

CAUTION: Use water only. Solvents or cleaners can damage the touch screen. Do not pour or spray water directly onto the touch screen.

Clean the scanning glass, scanning strip, and automatic document feeder (ADF) duplex background

The scanning glass, scanning strip, and ADF duplex background should be cleaned periodically or any time a scanned image has streaks.

To clean these components, follow these steps:

1. Press the Power button to turn off the product, and then disconnect the power cable.
2. Open the scanning lid.

3. Clean the scanning glass and scanning strip with a soft, lint-free cloth that has been sprayed with a mild glass cleaner.



⚠ CAUTION: Use only glass cleaner to clean the scanning glass and scanning strip. Avoid cleaners that contain abrasives, acetone, benzene, and carbon tetrachloride, all of which can damage the scanning glass. Avoid isopropyl alcohol because it can leave streaks on the glass.

Do not spray the glass cleaner directly on the scanning glass or scanning strip. If too much glass cleaner is applied, the cleaner could leak under the scanning glass or scanning strip and damage the product.

4. Dry the glass with a dry, soft, lint-free cloth.

5. Close the scanning lid, and then raise the scan input tray until it is perpendicular to the product.



6. Press in on the ADF duplex background tabs to release the ADF duplex background (1), and then pull forward to remove the ADF duplex background from its housing (2).

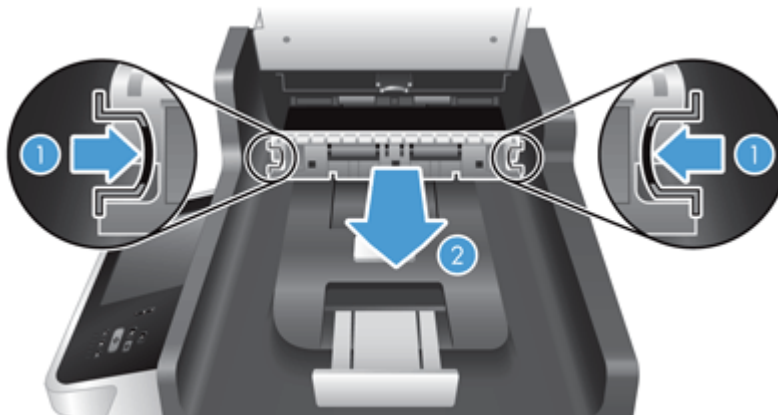

7. Wipe the two scanning strips (one black, one white) on the ADF duplex background (1) and the strip inside the ADF duplex background enclosure (2) with a soft, lint-free cloth that has been moistened with warm water.

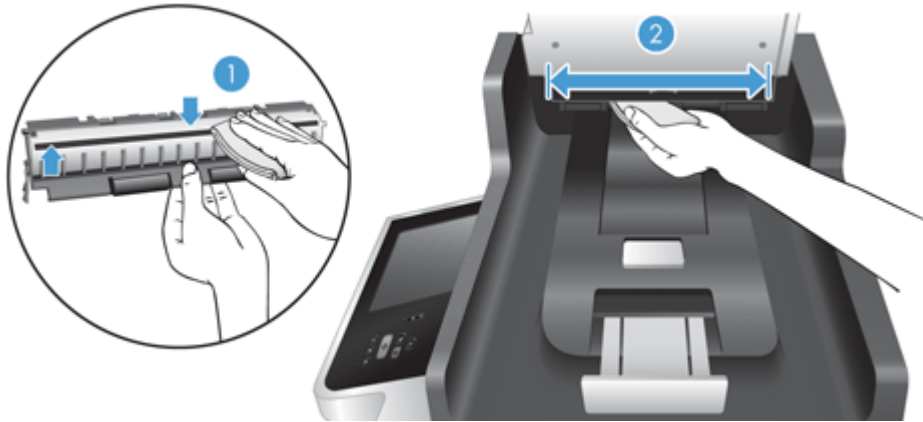

8. Dry the scanning strips with a dry, soft, lint-free cloth, and then slide the component into its housing until both tabs click into place.



9. Lower the scan input tray into place, and then reconnect the power supply to the product.
10. Press the Power button to turn on the product.

Clean the rollers

Clean the rollers under the following conditions:

- You experience repeated document jams.
- The product does not pull pages into the paper path.
- The scanned images are elongated.
- You frequently scan any of the following types of documents: coated paper, chemically treated documents such as carbonless paper, documents with a large amount of calcium carbonate, documents written with pencils, documents on which the toner has not fused.

To clean the rollers, follow these steps:

1. Press the Power button to turn off the product, and then disconnect the power cable.

2. Open the automatic document feeder (ADF) hatch.



3. Remove any visible lint or dust from each of the feed rollers and the separation pad using compressed air or a clean lint-free cloth moistened with warm water.

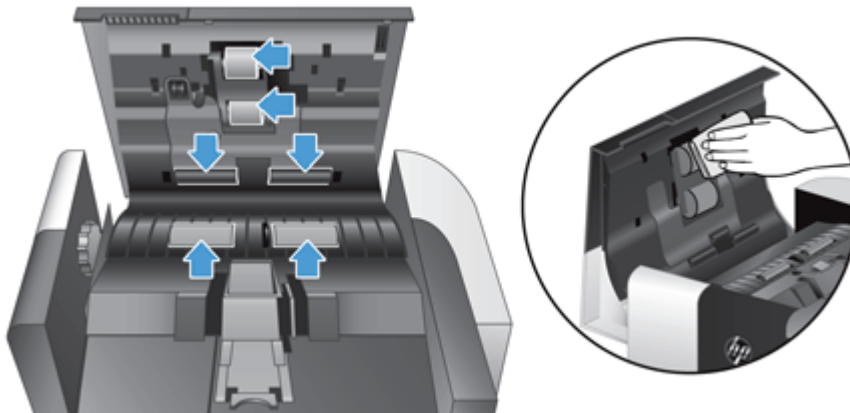

4. Close the ADF hatch, and then reconnect the power supply to the product.
5. Press the Power button to turn on the product, and then update the product maintenance history.
 - a. On the Home screen, touch the [Device Maintenance](#) button.
 - b. Touch the [Clean Rollers](#) button.
 - c. Scroll down through the online maintenance procedure and touch the [Complete Maintenance Procedure](#) button.
 - d. Touch [OK](#) to record the maintenance activity and reset the counters to zero.

8 Replace and install components

This section presents information about how to replace and install product components.

- [Replace the rollers](#)
- [Replace the separation pad](#)
- [Replace the front panel](#)
- [Replace the keyboard](#)
- [Replace the hard drive](#)
- [Install a Jetdirect card](#)
- [Install an accessory into the hardware integration pocket](#)

Animations which guide you through several maintenance tasks are available on the web. For the latest parts information and animations, see www.hp.com/support, and search on your product.

Replace the rollers

Replace the rollers under the following conditions:

- When the message **Document Feeder Kit Low** displays in the status line on the Home screen (a warning button displays to the right of the status line).
- If you experience repeated document jams and cleaning the rollers did not help.

 **TIP:** An animation which guides you through removing and replacing the rollers is available on the web (see www.hp.com/support, and search on your product).

The roller replacement kit includes a replacement separation pad. Make sure to replace the separation pad when you replace the rollers. To order the replacement kit, see www.hp.com/buy/parts.

 **NOTE:** The roller replacement kit is a consumable and is not covered under warranty or standard service agreements.

To replace the rollers, follow these steps:

1. Press the Power button to turn off the product, and then disconnect the power cable.

2. Open the automatic document feeder (ADF) hatch.



3. Slide your fingertip behind the tab on the roller assembly door, and then pull gently forward and down to open the door.

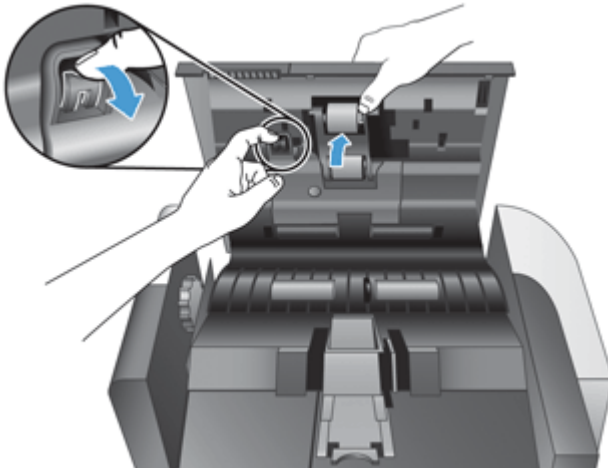

4. Holding the roller assembly door down and out of the way, grasp the roller assembly and slide it to the left to release it from the enclosure.

CAUTION: Do not touch the rollers with bare fingers, as oils from your fingers could impact performance.

NOTE: You might feel a slight resistance when sliding the roller assembly.

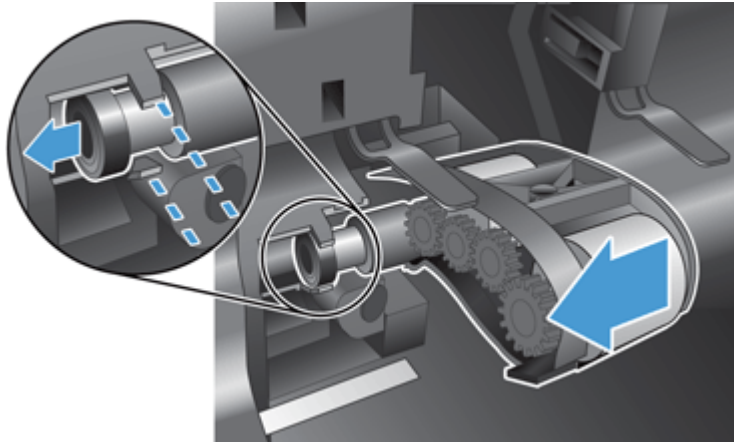

CAUTION: Take care not to press down on the alignment tabs (1) or against the tab to the right of the roller assembly (2).

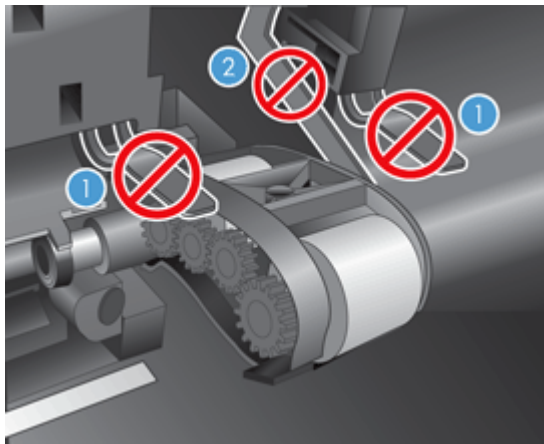

5. Lift the roller assembly out and set it aside.

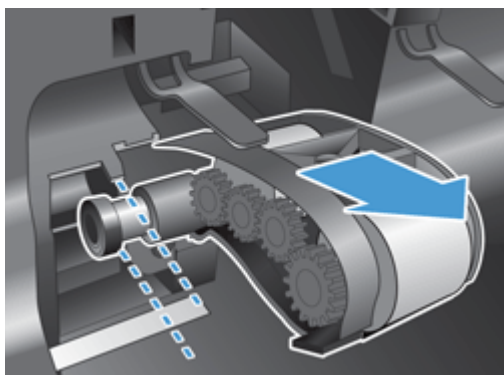

6. Holding the roller assembly door down and out of the way, insert the new roller assembly into the enclosure and slide it to the right until it is seated firmly.

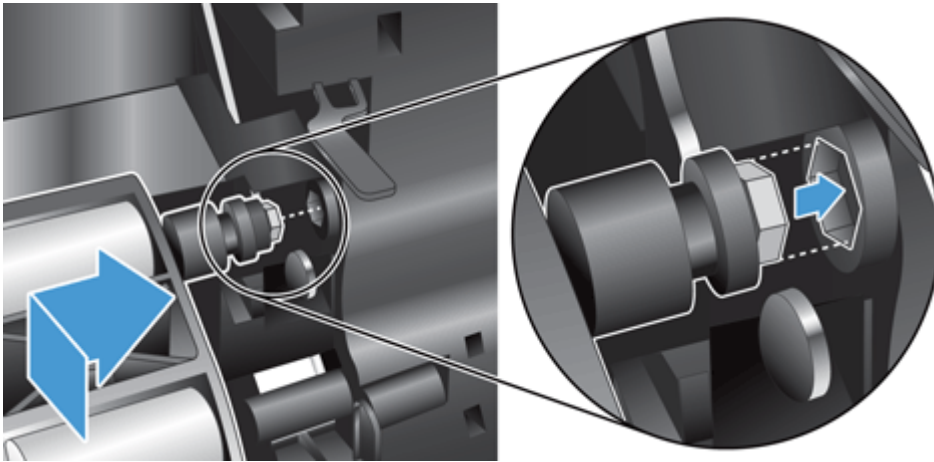

7. Close the roller assembly door, pressing firmly against the door until you hear a click (the click indicates that the latch is seated correctly).

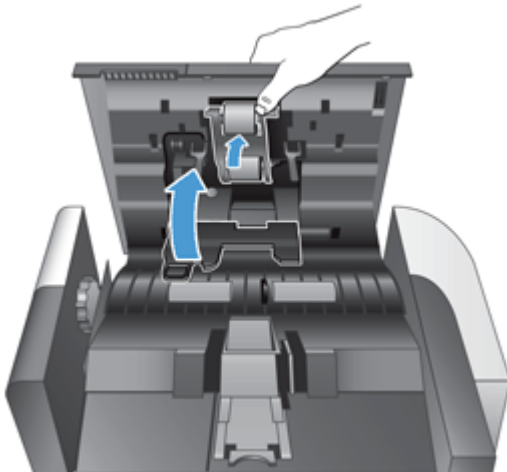

 **NOTE:** HP recommends that you replace the rollers and separation pad every 100,000 scans.

Once the rollers are replaced, replace the separation pad and then log the maintenance activity.

Replace the separation pad

The roller replacement kit includes a replacement separation pad. Always replace the separation pad when you replace the rollers. To order the roller replacement kit, see www.hp.com/buy/parts.

 **TIP:** An animation which guides you through removing and replacing the separation pad is available on the web (see www.hp.com/support, and search on your product).

To replace the separation pad, follow these steps:

1. Make sure the scanner is turned off and the power cable is disconnected.

2. Open the automatic document feeder (ADF) hatch.



3. Raise the ADF input tray (1), and then press forward on the separation pad latch to release the separation pad from its locked position (2).

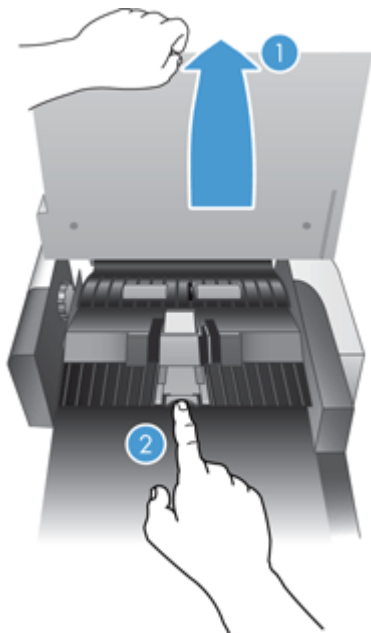

4. Lift up on the separation pad component, release it from its housing, and set it aside.

 **TIP:** This is easier to do if you lower the input tray.

 **CAUTION:** Do not touch the pad itself with bare fingers, as oils from your fingers could impact performance.

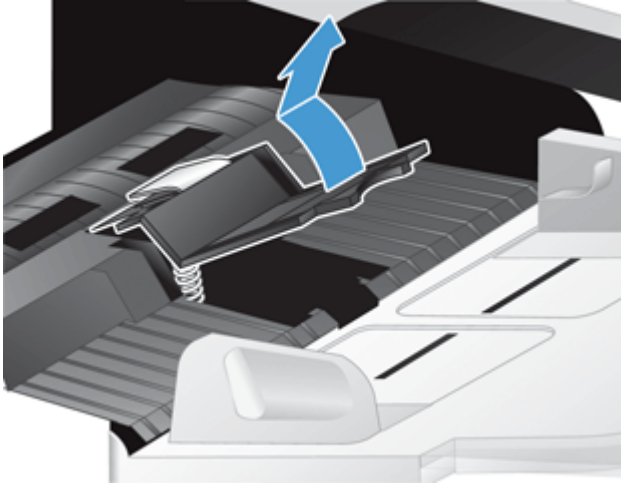

5. Slide the rear edge of the new separation pad component into its housing, ensuring that the spring below the pad is not bent down.

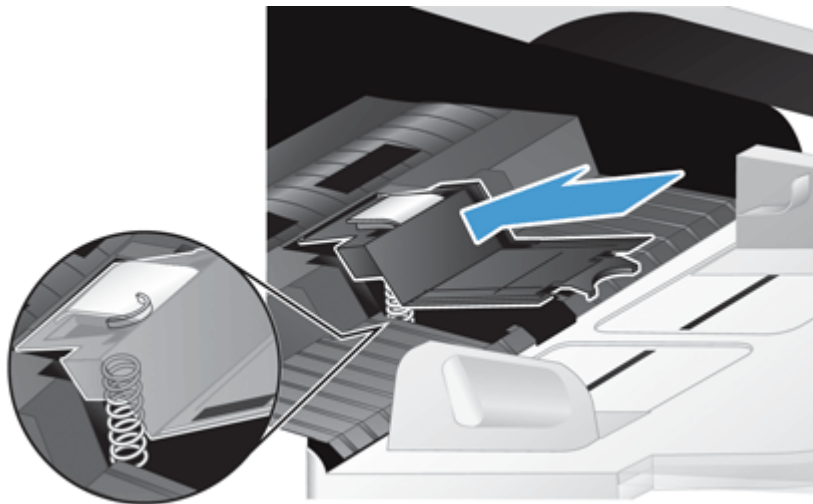

6. Press down on the front portion of the separation pad component until you hear an audible click, indicating that the pad is seated firmly.

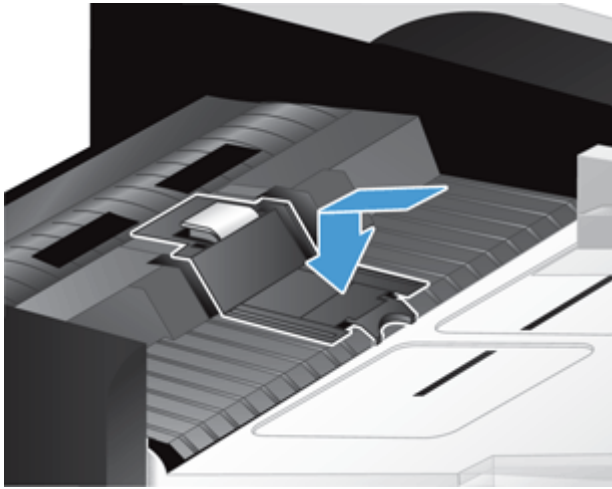

 **TIP:** Taking care not to touch the pad with bare fingers, press down on the pad and then release, ensuring that the pad springs back up. This indicates that the spring below the pad is positioned correctly.

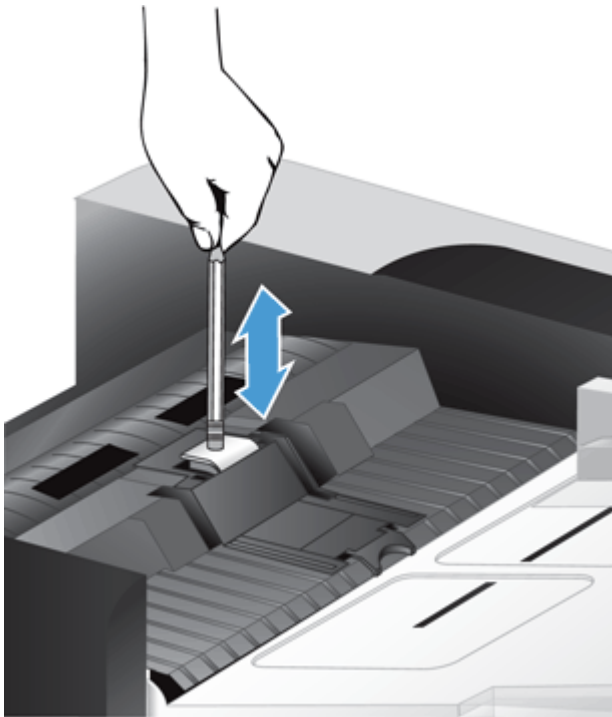

7. Close the ADF hatch, reconnect the power supply to the product, and then turn on the product.
8. Update the product maintenance history.
 - a. On the Home screen, touch the [Administration](#) button.
 - b. Touch the [Manage Supplies](#) button, touch the [Reset Supplies](#) option, and then touch the [New Document Feeder Kit](#) option.

- c. Scroll down through the online maintenance procedure and touch the [Complete Maintenance Procedure](#) button.
- d. Touch **OK** to record the maintenance activity and reset the counters to zero.

 **NOTE:** HP recommends that you replace the rollers and separation pad every 100,000 scans.

Replace the front panel

 **TIP:** An animation which guides you through removing and replacing the front panel is available on the web (see www.hp.com/support, and search on your product).

To replace the front panel, follow these steps:

1. Press the Power button to turn off the product, and then disconnect the power cable.
2. Raise the scan lid.
3. Locate the indents on the underside of the front panel, press in at the location shown, and then lift the front panel gently as it releases.

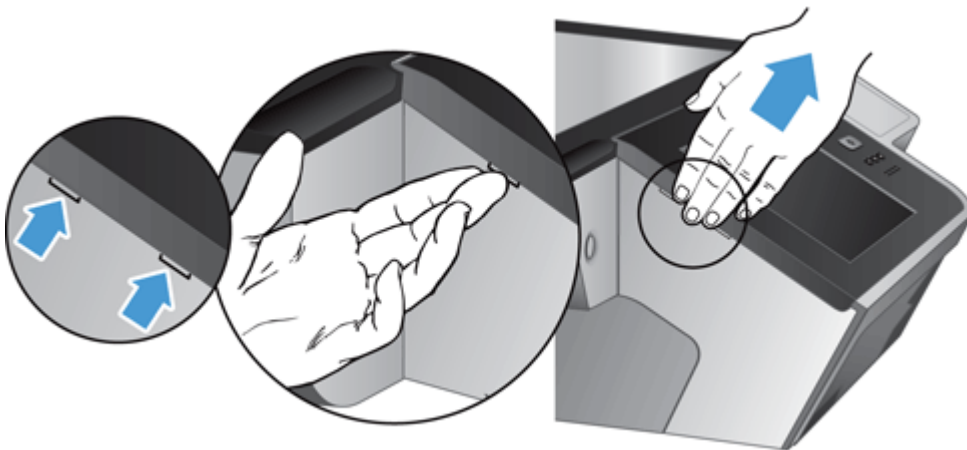

4. Invert the front panel, hold it firmly with one hand, disconnect the ribbon cable (1), and then gently pull the ribbon cable through the cable restraint (2).

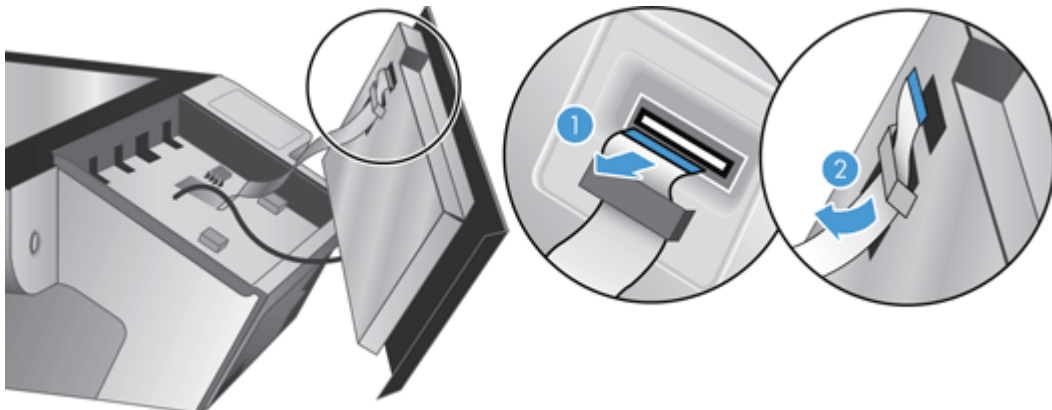

5. While still holding the front panel in an inverted position, disconnect the front panel cable and set the front panel aside.

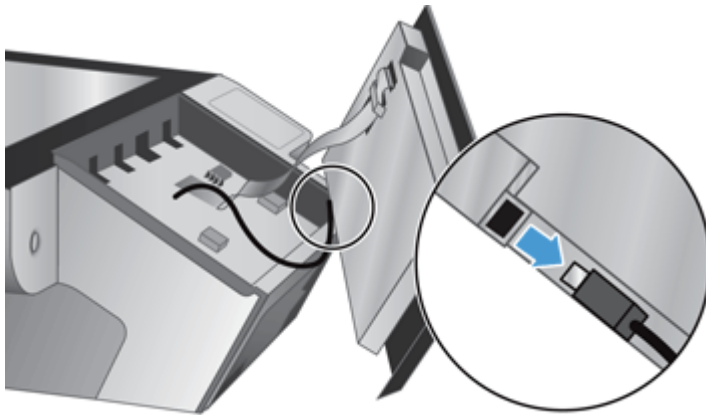

6. Connect the new front panel to the front panel cable.

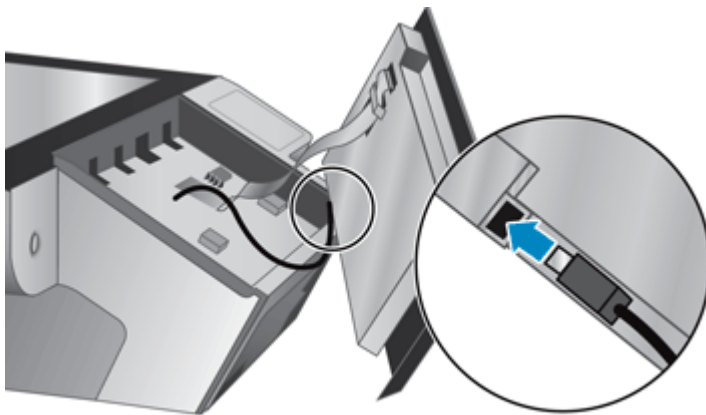

7. Gently feed the ribbon cable through the cable restraint (1) and connect the ribbon cable (2).

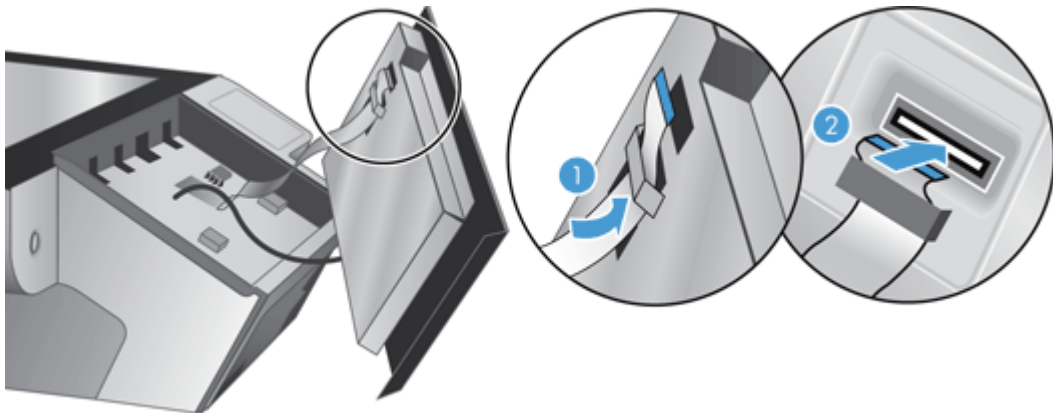

8. Invert the front panel so that it is touch screen side up, position the front panel to align with the bezel (1), and then press down on the front panel to seat it in place (2).

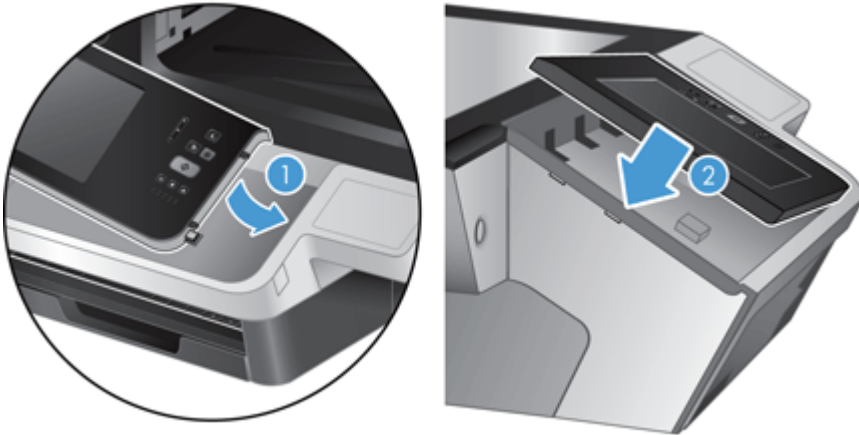

9. Close the scan lid, reconnect the power cable, and then turn on the product.

Replace the keyboard

You can order keyboards in several languages as accessories.

To replace the keyboard, follow these steps:

1. Press the Power button to turn off the product, and then disconnect the power cable.
2. Remove the keyboard.
 - a. Slide the four sliding tabs toward the front of the product to release the keyboard (1), and then gently lift the keyboard up and away from the keyboard frame (2).



- b.** Gently squeeze in on the cable connector to release the keyboard cable, and then set the keyboard aside.

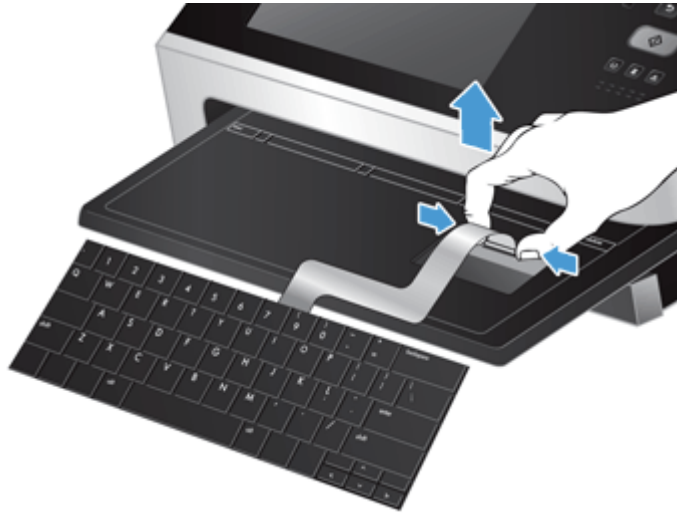

- 3.** Insert the new keyboard.
 - a.** Connect the new keyboard's cable.



- b.** Position the new keyboard over the keyboard frame so the fixed tabs on the keyboard align with the tab slots on the frame (1), gently push the keyboard against the keyboard frame (2), and then push the four sliding tabs in to secure the keyboard (3).

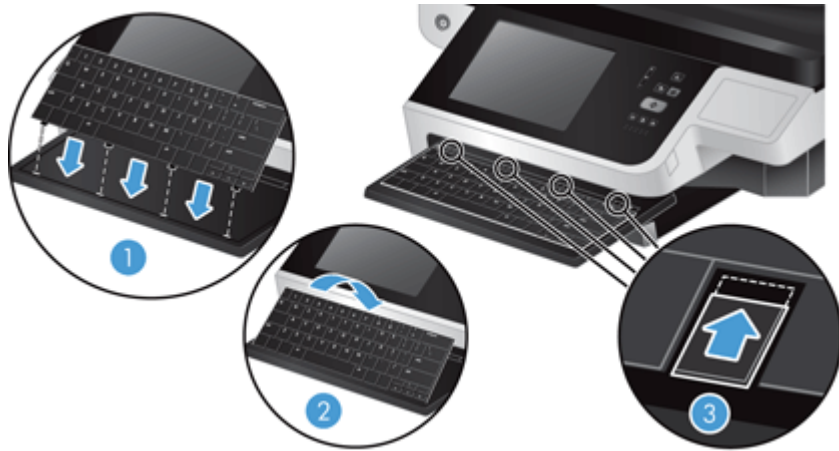

- 4.** Reconnect the power supply to the product, and then press the **Power** button to turn on the product.

Replace the hard drive

HP recommends doing routine, scheduled backups as a best practice. Doing routine backups will minimize data loss in the event of a hard drive failure.

To replace the hard drive, follow these steps.

- 1.** Press the **Power** button to turn off the product (1), disconnect power from the product (2), and then disconnect the Ethernet cable (3).

If used, remove the cable-style lock (sometimes called a “Kensington lock”).

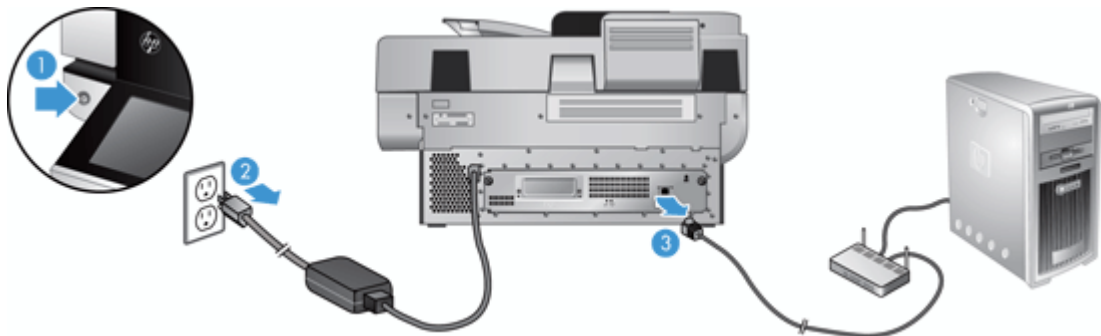

2. Loosen the two thumbscrews which secure the rear panel drawer assembly to the product (1), and then slide the drawer assembly out of its enclosure.

You may encounter some resistance as you slide the drawer assembly.

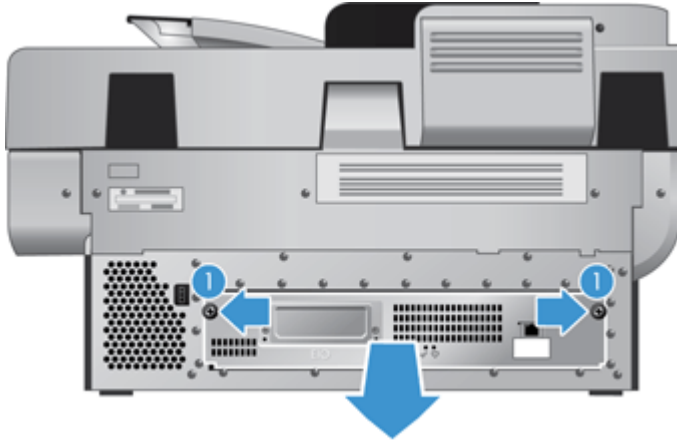

3. Gently lift the drive rail lever on the left leading edge of the hard drive (1), slide the drive forward (2), and then disconnect the cable from the hard drive.

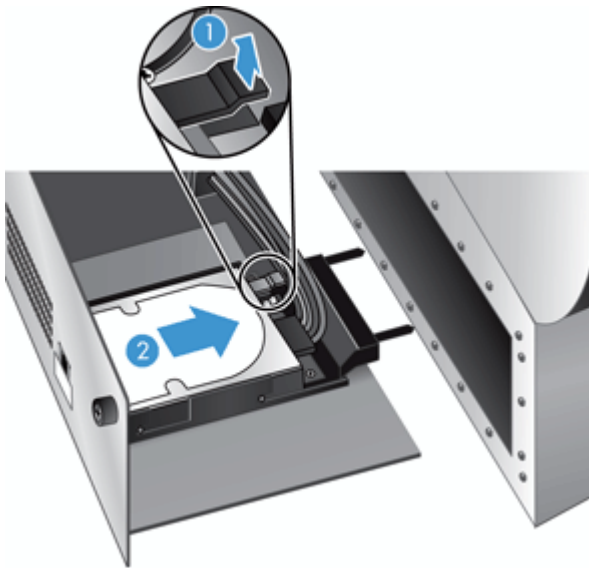

4. Lift the hard drive out of the drawer assembly and set the hard drive aside.

5. Remove the black plastic rails from the drive you just removed, and then attach them to the new drive.

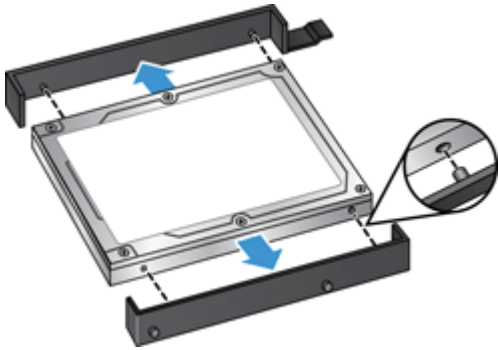

6. Slide the hard drive into the drive housing until it snaps into place (ensure that the pegs on the side of the drive rails fit into the slot on the drive housing), and then connect the drive cable to the drive.



NOTE: Make sure to tuck the drive cable under the cable restraint.

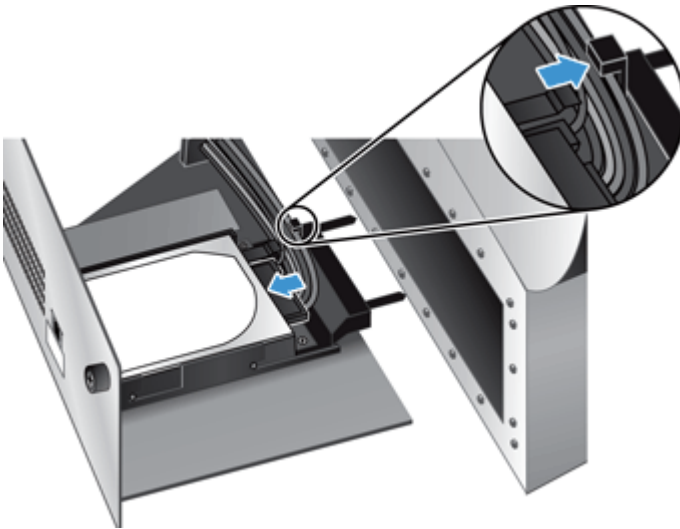

7. Slide the rear panel drawer assembly into place (taking care that no cables are pinched), ensure that the drawer assembly is seated firmly against the chassis, and then tighten the thumbscrews.
8. Reconnect the power and Ethernet cables, and, optionally, the cable-style lock, and then press the Power button to turn on the product.

Install a Jetdirect card

To install a Jetdirect card, follow these steps.

1. Press the Power button to turn off the product (1), disconnect power from the product (2), and then disconnect the Ethernet cable (3).

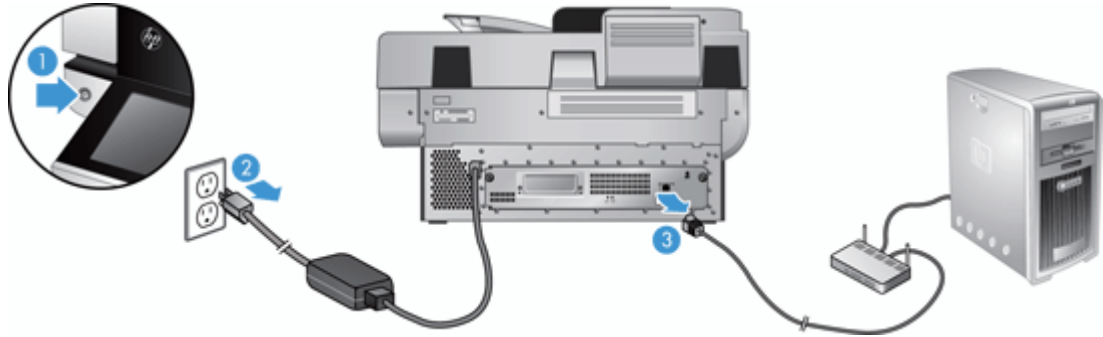

2. Loosen the two screws which secure the Jetdirect card cover plate to the back of the product (1), and then remove the cover plate (2) and set it aside.

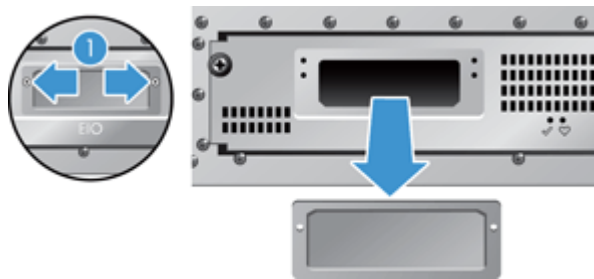

3. Remove the replacement Jetdirect card from its packaging and insert the card into the card slot ledge-side up, as shown.

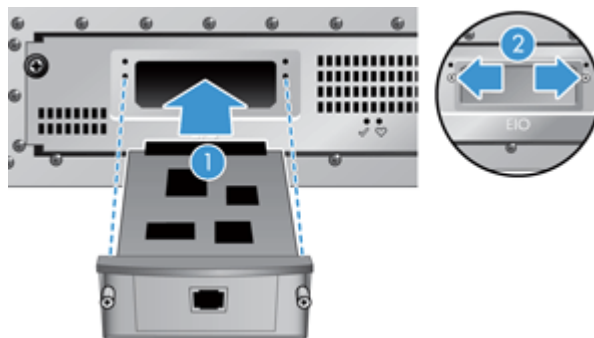

- a. Align the card with the guide rails in the slot.
- b. Firmly press the card into the slot until the card is seated (2), and then secure the card with the card plate screws (1).

4. Connect the Ethernet cable to the formatter (1), reconnect power (2), and then press the Power button to turn on the product (3).

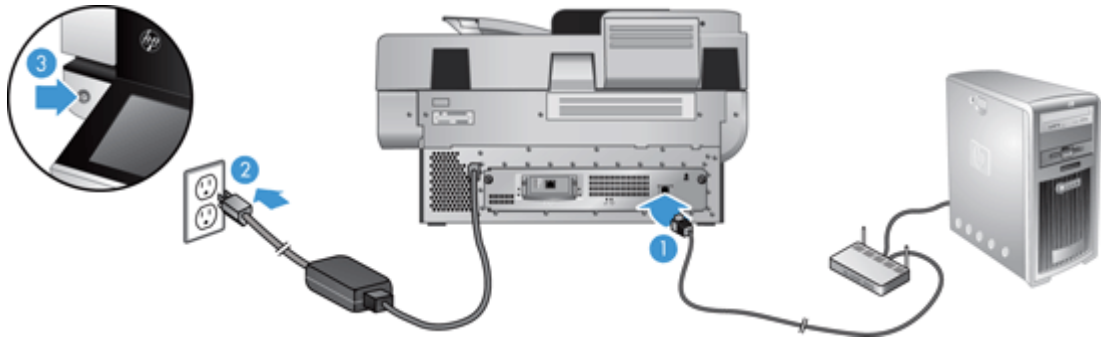

Install an accessory into the hardware integration pocket

You can install a separately-purchaseable HP accessory (for example, a proximity reader, fingerprint reader, or magnetic-swipe reader) into the integrated hardware integration pocket (HIP).

NOTE: This procedure describes installing a proximity card reader. Steps identified as **if applicable** might not apply to other HIP accessories. Always refer to the installation instructions that came with your accessory.

To install an accessory into the HIP, follow these steps:

1. Press the Power button to turn off the product (1), and then disconnect the power cable (2)..

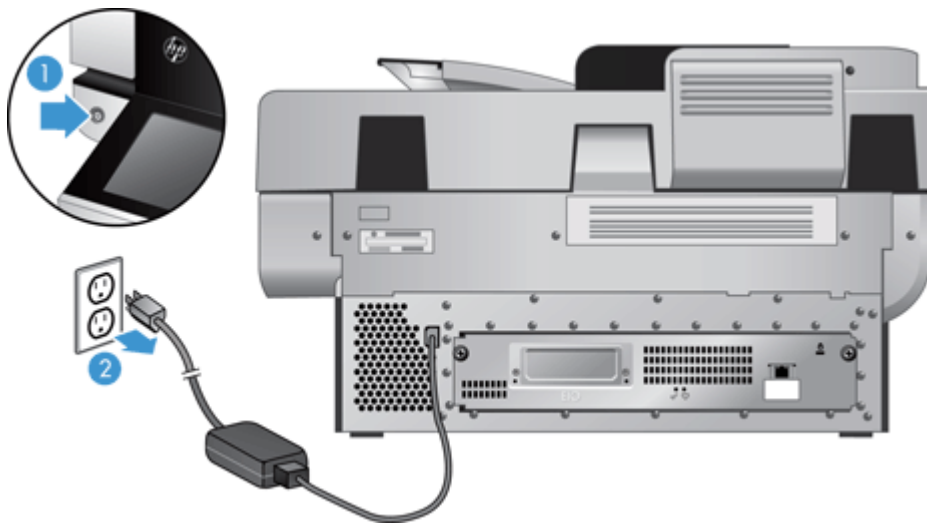

2. Insert the edge of a credit card into the groove at the top of the HIP cover and gently pry the cover free; set the cover aside.

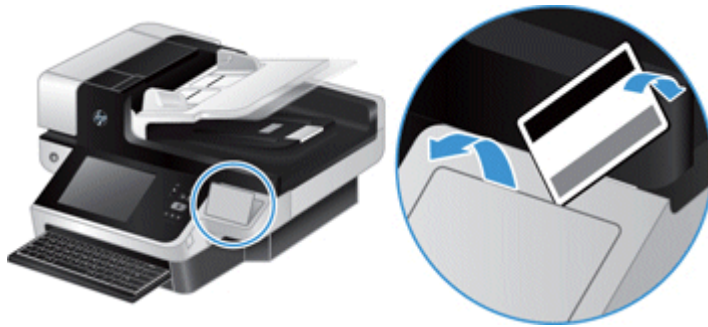

3. Remove the HIP accessory from its packaging and install the accessory into the HIP.
 - a. Connect the accessory's USB cable into the connector on the left side of the HIP enclosure.



- b. Connect the USB cable to the cable connector on the accessory (1), and then connect the grounding connector to the grounding strip on the accessory, if applicable (2).

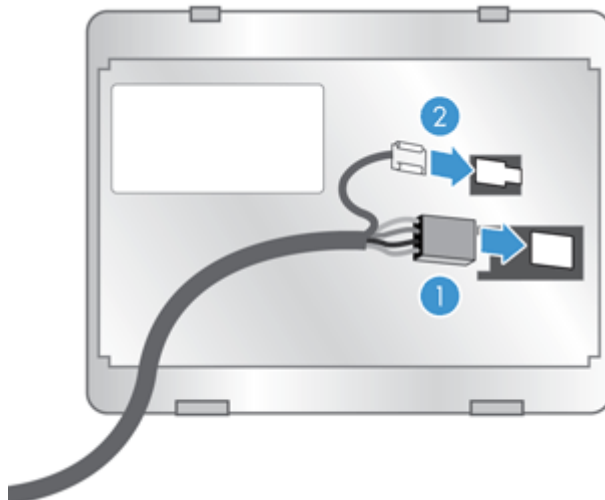

 **NOTE:** The connectors shown are for a proximity card reader. The cable connector for your accessory might be slightly different, and might not include a ground connector.

- c. Align the pegs on the underside of the accessory with the connectors in the HIP, insert the accessory into the HIP, and then press down gently to snap the accessory into place.

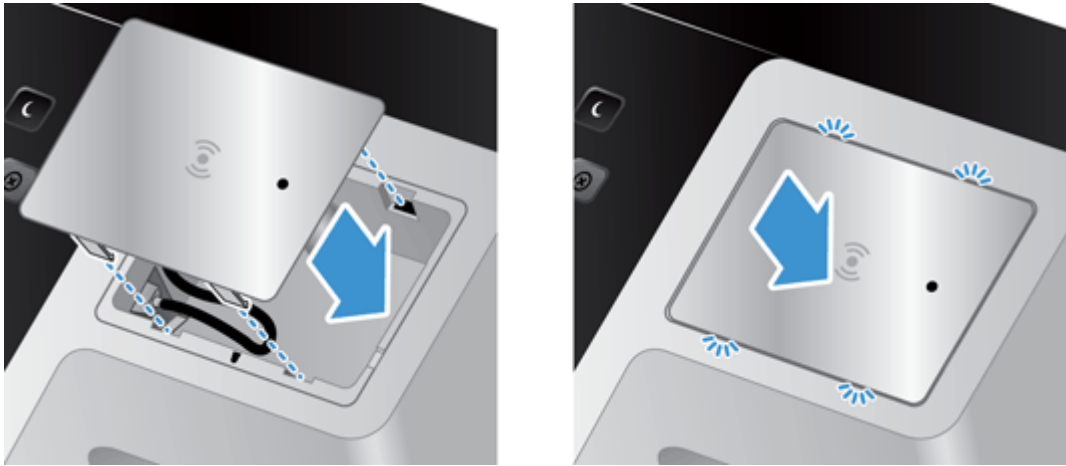

- 4. Connect the power cable, and then press the Power button to turn on the product.

9 Troubleshooting

This section contains solutions for common problems with the product.

- [Scan errors](#)
- [Basic troubleshooting tips](#)
- [Installation problems](#)
- [Initialization or hardware problems](#)
- [The product has paused or shut down](#)
- [Paper feeding problems](#)
- [The product has stopped working correctly](#)
- [Solve e-mail problems](#)
- [Solve network problems](#)
- [Restore factory settings](#)
- [Contact HP Support](#)

For additional troubleshooting, see the Help for the HP scanning program that you are using.

Scan errors

Follow the displayed instructions and, if applicable, video to resolve an error.

Error	Description
ADF empty	No document was detected in the document feeder.
Automatic calibration failed	A hardware failure occurred when the product attempted to calibrate prior to scanning.
Communication failed	A scanner communication failure occurred.
Fan failed	The product's fan failed.
Hardware error	A hardware failure occurred.
Hatch open	The hatch on the document feeder is open or not securely latched.
Lamp failed	The product lamp failed.
Mispick	The product has detected a document feeder page mispick (for example, no pages fed through the product).
Multi-pick	The product has detected a multiple-page feed error.
Multi-pick sensor failed	The product's multi-pick paper sensor has failed.
Paper jam	The product has detected a document feeder paper jam.

Basic troubleshooting tips

Simple issues such as smudges on the scanning glass or loose cables can cause your product to produce fuzzy scans, operate in an unexpected manner, or fail to operate. Always check the following items when you encounter scanning problems.

- If scans are fuzzy, check to see if the scanning strip to the left of the scanning glass is dirty or smudged. If so, clean the scanning strip.

If you are scanning a document that will be analyzed using Optical Character Recognition (OCR), make sure that the original document is clear enough to be analyzed.

- Make sure that the Ethernet and power cables are firmly seated in their respective connectors on the back of the product, and that the power cord is plugged into a working electrical outlet or surge protector.
- Ensure that the product is receiving power.
 - Check that the green LED on the power supply case is on.
 - If the green LED is not on, ensure that power is available to the power outlet or surge protector that the power supply is plugged into.
 - If power is available to the power outlet or surge protector but the green LED is still not on, the power supply might be defective. Contact www.hp.com/support for assistance.
- Make sure that the two formatter status LEDs on the back panel drawer assembly are green (one should glow steadily, the other should blink). This indicates that the formatter is functioning correctly.
- Make sure that the product buttons are enabled.
- Press the Power button to turn off the product, wait 30 seconds, and then press the Power button again to turn on the product.
- Make sure the automatic document feeder (ADF) hatch is closed.
- Verify that the product is connected to the LAN, and that the product is correctly configured to use the network.

If you continue to have problems, it is possible that your firmware or associated drivers are out of date or have become corrupted. See www.hp.com/support to locate firmware and driver updates for your product.

Installation problems

Cable type	Action
Power supply cable	<p>The power supply is connected between the product and a power outlet.</p> <ul style="list-style-type: none">• Ensure that the power supply is securely connected to the product.• Ensure that the power cable is securely connected between the power supply and a live electrical outlet or surge protector.• If the power cable is connected to a surge protector, ensure that the surge protector is plugged into an outlet and turned on.• Press the Power button to turn off the product, wait 30 seconds, and then press the Power button again to turn on the product.
Ethernet cable	<p>Ensure that the Ethernet cable is securely connected between the product and a network router, Ethernet jack, or Ethernet switch.</p> <p>For additional Ethernet troubleshooting information, see www.hp.com/support, select your country/region, and then use the search tool to find Ethernet or network troubleshooting topics.</p>

Initialization or hardware problems

- [Check the Ethernet connection](#)
- [Check that the product has power](#)
- [Reset the product](#)

Check the Ethernet connection

1. Ensure that the Ethernet cable is firmly connected between the product and a router, Ethernet jack, or Ethernet switch.
2. If the Ethernet cable is connected to a network router or Ethernet switch, try connecting it to a different port on the router or switch.
3. Press the Power button to turn off the product, wait 30 seconds, and then press the Power button again to turn on the product.

Check that the product has power

The power cable is connected between the product and a power outlet.

- Ensure that the power cable is securely connected between the product and a live electrical outlet.
- If the power cable is connected to a surge protector, ensure that the surge protector is plugged into an outlet and turned on.
- Ensure that the product is receiving power.
 - Check that the green LED on the power supply case is on.
 - If the green LED is not on, ensure that power is available to the power outlet or surge protector that the power supply is plugged into.
 - If power is available to the power outlet or surge protector but the green LED is still not on, the power supply might be defective. Contact www.hp.com/support for assistance.

If the problem persists after verifying the above items, follow these steps:

1. Press the Power button to turn off the product, and then disconnect the power cable.
2. Wait 30 seconds.
3. Reconnect the power cable, and then turn on the product.

Reset the product

If you receive an error message similar to **Scanner initialization failed** or **Scanner not found** when trying to use the product, you should reset the product.

To reset the product, follow these steps:

1. Press the Power button to turn off the product, and then disconnect the power cable.
2. Wait 30 seconds.
3. Reconnect the power cable, and then press the Power button.

The product has paused or shut down

- [The product is displaying a “pause” message on the touch screen](#)
- [I received an e-mail indicating that the product has shut down](#)

The product is displaying a “pause” message on the touch screen

The product has detected that the hard drive is overheating, and will shut itself down after displaying the “pause” message for 12 minutes.

I received an e-mail indicating that the product has shut down

The product has detected that the hard drive is overheating because of a fan failure. To protect hard drive data, the product has shut itself down.

Paper feeding problems

- [Paper jamming, skewing, misfeeds, or multiple-page feeds](#)
- [Scanning fragile originals](#)
- [Paper does not feed from the product](#)
- [Originals are curling up in the document output tray](#)
- [The bottom of the scanned image is cut off](#)
- [The scanned images have streaks or scratches](#)
- [An item loaded in the document input tray jams repeatedly](#)
- [Clear jams from the paper path](#)

Paper jamming, skewing, misfeeds, or multiple-page feeds

- Check that all rollers are in place and that the roller doors and automatic document feeder (ADF) hatch are closed.
- If the pages look skewed as they feed into the paper path, check the resulting scanned images in the software to ensure that they are not skewed.
- The pages might not be placed correctly. Straighten the pages and adjust the paper guides to center the stack.
- The paper guides must be touching the sides of the paper stack to work properly. Please ensure that the paper stack is straight and the guides are against the paper stack.
- The document feeder or output tray might contain more than the maximum number of pages. Load fewer pages in the document feeder, and remove pages from the output tray.
- Verify that there are no pieces of paper, staples, paper clips, or other debris in the paper path.
- Clean the paper path to help reduce misfeeds. If misfeeds still occur, clean the rollers. If misfeeds still occur, replace the rollers.

Scanning fragile originals

To safely scan fragile originals (photographs or documents on wrinkled or very lightweight paper) place originals on the scanning glass. Do not use the automatic document feeder (ADF).

Paper does not feed from the product

Reload the pages into the document feeder, ensuring that they make contact with the rollers.

The automatic document feeder (ADF) hatch might not be securely latched. Open the ADF hatch and then close it by pressing firmly.

A problem with the product hardware might exist. Follow this procedure to test the product:

1. Ensure that the power supply is securely connected between the product and a live electrical outlet or surge protector. Check that the green LED on the power supply case is on to verify that the power supply is functional.
2. If the power supply is connected to a surge protector, ensure that the surge protector is plugged into an outlet and turned on.
3. Press the Power button to turn off the product, and then disconnect the power cable.
4. Wait 30 seconds.
5. Reconnect the power cable to the product, and then press the Power button.
6. Try to rescan.

Originals are curling up in the document output tray

Under dry conditions, lightweight originals such as those printed on carbonless copy paper may curl in the output tray. To minimize curl, flatten curled edges on the originals before placing them in the document feeder. If you cannot flatten curled edges, make sure the curled edges are facing down when you place the originals in the document feeder.

The bottom of the scanned image is cut off

By default, the scanning software can scan media that is up to 356 mm (14 in) long. For longer pages, the end of the document is not included in the scanned image.

The scanned images have streaks or scratches

After each step, try another scan to see if the streaks or scratches are still apparent. If so, then try the next step. For information on cleaning the product, see the **Care and maintenance** section.

- Check that the originals are clean and unwrinkled.
- Clean the scanning strip, which is to the left of the scanning glass.
- Clean the rollers manually.

An item loaded in the document input tray jams repeatedly

- The item might not meet the guidelines for acceptable originals.
- The item might have something on it, such as staples or self-adhesive notes on the original that must be removed.
- Make sure the paper guides touch the edges of the original.

Clear jams from the paper path

To clear a paper jam:

1. Open the automatic document feeder (ADF) hatch.



2. Remove the originals or any obstructions from the paper path.

 **TIP:** Use the green thumb wheel on the left side of the open hatch to manually advance originals through the paper path.

3. Remove the ADF duplex background, remove any debris, and then slide the component back into its housing until it clicks into place.

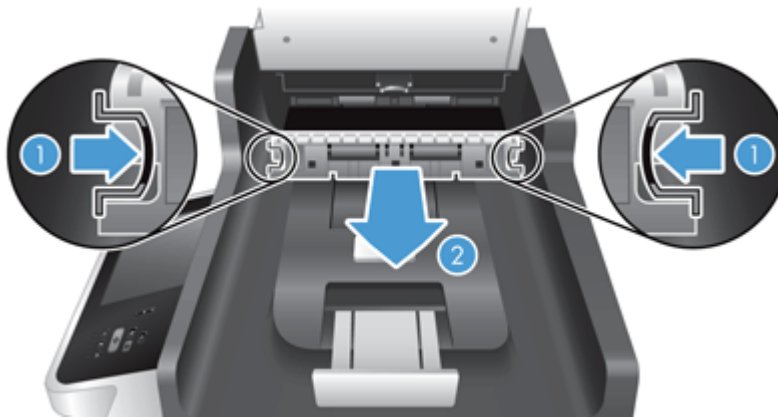

4. Close the ADF hatch until it snaps into place.
5. Reload the unscanned originals in the document feeder.
6. Resume scanning.

If you experience repeated jams, ensure that the hatch door is fully closed.

The product has stopped working correctly

If the product stops scanning, follow these steps. After each step, start a scan to see if the product is working. If the problem persists, proceed with the next step.

1. A cable might be loose. Ensure that the Ethernet, power supply, and power cables are properly connected.
2. Ensure that the product is receiving power.
 - a. Check that the green LED on the power supply case is on.
 - b. If the green LED is not on, ensure that power is available to the power outlet or surge protector that the power supply cable is plugged into, and that the power cable is securely connected to the power supply and the product.
 - c. If power is available to the power outlet or surge protector but the green LED is still not on, the power supply might be defective. See www.hp.com/support for assistance.
3. Press the Power button to turn off the product, wait 30 seconds, and then touch the Power button again to turn on the product.

Solve e-mail problems

If you are unable to send e-mails by using the digital-send feature, you might need to reconfigure the SMTP gateway address or the LDAP gateway address. View a configuration page to find the current SMTP and LDAP gateway addresses. Use the following procedures to check if the SMTP and LDAP gateway addresses are valid.

Validate the SMTP gateway address



NOTE: This procedure is for Windows operating systems.

1. Open an MS-DOS command prompt: click **Start**, click **Run**, and then type `cmd`.
2. Type `telnet` followed by the SMTP gateway address and then the number 25, which is the port over which the product is communicating. For example, type `telnet 123.123.123.123 25` where "123.123.123.123" represents the SMTP gateway address.
3. Press **Enter**. If the SMTP gateway address is *not* valid, the response contains the message `Could not open connection to the host on port, 25: Connect failed`.
4. If the SMTP gateway address is not valid, contact the network administrator.

Validate the LDAP gateway address



NOTE: This procedure is for Windows operating systems.

1. Open Windows Explorer. In the address bar, type `LDAP://` immediately followed by the LDAP gateway address. For example, type `LDAP://12.12.12.12` where "12.12.12.12" represents the LDAP gateway address.
2. Press **Enter**. If the LDAP gateway address is valid, the **Find People** dialog box opens.
3. If the LDAP gateway address is not valid, contact the network administrator.

Solve network problems

Check the following items to verify that the product is communicating with the network. Before beginning, view the information pages.

If you still cannot connect to the network after checking these items, see www.hp.com/support.

1. Are your power and power supply cables connected properly, and is the product turned on?
2. Are your network cables connected properly?

Make sure that the product is attached to the network using the appropriate port and cable. Check each cable connection to make sure it is secure and in the right place. If the problem continues, try a different cable or ports on the hub or transceiver.

3. Are the link speed and duplex settings set correctly?

Hewlett-Packard recommends leaving this setting in automatic mode (the default setting).

4. Can you "ping" the product using its IP address?

Use the command prompt to ping the product from your computer. For example:

```
ping 192.168.45.39
```

Ensure that the ping displays round-trip times.

If you are able to ping the product, verify that the IP address configuration for the product is correct on the computer. If it is correct, delete and then add the product again.

If the ping command failed, verify that the network hubs are on, and then verify that the network settings, the product, and the computer are all configured for the same network.

5. Have any software applications been added to the network?

Make sure they are compatible and that they are installed correctly.

6. Is your protocol enabled?

Use the Embedded Web Server to check the status of protocols.

7. Does the product appear in HP Web Jetadmin or other management application?

- Verify network settings on the Network configuration screen.
- Confirm the network settings for the product using the product control panel.

Restore factory settings

To restore factory settings, follow these steps:.

1. Touch the [Administration](#) button, touch the [General Settings](#) button, and then touch the [Restore Factory Settings](#) button.
2. Touch the buttons associated with the subsystems you wish to reset to factory defaults, and then touch the [Reset](#) button.

Contact HP Support

For support contact information, see www.hp.com/support.

10 Specifications and warranty

This section contains regulatory information and product specifications for your product.

- [Product specifications](#)
- [Document feeder specifications](#)
- [Environmental specifications](#)
- [Certificate of Volatility](#)
- [Regulatory model number](#)
- [Environmental product stewardship program](#)
- [Hewlett-Packard limited warranty statement](#)

Product specifications

Name	Description
Scanner type	Flatbed with automatic document feeder (ADF)
Size	Width: 570 mm (20.35 in), Depth: 434.6 mm (17.1 in), Height: 206.6 mm (8.14 in)
Weight	19.1 kg (42.1 lbs)
Scanning element	Charge-coupled device (CCD)
Optical resolution	600 x 600 dpi hardware
Network specifications	<ul style="list-style-type: none">• 10/100/Gigabit Ethernet• IPSec (authentication and encryption protocols)• IPv4 and IPv6 address assignment
AC power	<ul style="list-style-type: none">• AC input for power supply: 100–240V~, 50/60Hz, 2600mA• DC output for power supply: +32 Vdc, 5625mA, 180W
Power consumption	For power consumption information, see www.hp.com/support .
System requirements	To view minimum and recommended system requirements, go to www.hp.com , select your country/region, search on your product model, and then search on datasheet .

Document feeder specifications

Name	Description
Paper tray capacity	100 sheets of 75 g/m ² (20 lb)

Name	Description
Minimum paper size	68 x 148 mm (2.7 x 5.8 in)
Maximum paper size	216 x 864 mm (8.5 x 34 in)
Minimum paper weight	49 g/m ² (13 lb)
Maximum paper weight	120 g/m ² (32 lb)

Environmental specifications

Name	Description
Temperature	Operating the product: 10° to 35° C (50° to 95° F)
	Storage: -40° to 65° C (-40° to 149° F)
Relative humidity	Operating the product: 10% to 80% noncondensing 10° to 35° C (50° to 95° F)
	Storage: up to 90% at 0° to 65° C (32° to 149° F)

 **NOTE:** In the presence of high electromagnetic fields, it is possible the output from the HP product may be slightly distorted.

 **NOTE:** HP is committed to providing our customers with information about the chemical substances in our products as needed to comply with legal requirements such as REACH (Regulation EC No 1907/2006 of the European Parliament and the Council). A chemical information report for this product can be found at www.hp.com/go/reach.

Certificate of Volatility

This statement explains the volatility of customer data stored in memory and outlines how to erase secure data from the device.

Volatile memory

The product utilizes volatile memory (1792 MB) to store customer data during the scan process. When you turn off the product, this volatile memory is erased.

Non-volatile memory

The product utilizes non-volatile flash memory (2 MB) to store system control data and user preference settings. Non-volatile memory does not store any customer scan data. To clear non-volatile memory and restore it to factory defaults, use the Embedded Web Server.

 **TIP:** You can also clear non-volatile memory from the Home screen on the control panel (touch [Administration](#), touch [General Settings](#), and then touch [Restore Factory Settings](#)).

Hard disk drive memory

The product contains one encrypted hard disk drive (160 GB or larger) that may retain data after you turn off the product, including customer jobs and temporary data such as stored scan data or fax files. To securely erase the data, start the Embedded Web Server, click the **Security** tab, click the **Protect Stored Data** entry in the left pane, click the **Erase Options** button, and then select the **Secure Sanitize Erase** option.

 **NOTE:** If you erase the drive using **Secure Sanitize Erase**, you will not be able to use the drive in any device (for example, another scanner or a computer) until you reformat the drive.

The **Secure Sanitize Erase** feature meets standards for clearing disk media defined in NIST Special Publication 800-88 Guidelines for Media Sanitation and the U.S. Department of Defense Updated DSS Clearing and Sanitization Matrix.

Regulatory model number

For regulatory identification purposes your product has been assigned a Regulatory Model Number. The Regulatory Model Number for your product is FCLSD-0901. This regulatory model number should not be confused with the marketing name (HP Digital Sender Flow 8500 fn1) or product number (L2719A). Additional regulatory information about your product can be found on the regulatory_supplement.pdf file in the product documentation.

Environmental product stewardship program

Protecting the environment

Hewlett-Packard Company is committed to providing quality products in an environmentally sound manner. This product has been designed with several attributes to minimize impacts on our environment.

Plastics

Plastic parts over 25 grams are marked according to international standards that enhance the ability to identify plastics for recycling purposes at the end of the product's life.

Energy information

Power usage drops significantly while in Ready or Sleep Mode, which saves natural resources and saves money without affecting the high performance of this product. Hewlett-Packard printing and imaging equipment marked with the ENERGY STAR® logo is qualified to the U.S. Environmental Protection Agency's ENERGY STAR specifications for imaging equipment. The following mark will appear on ENERGY STAR qualified imaging products:



Additional ENERGY STAR qualified imaging product model information is listed at:
<http://www.hp.com/go/energystar>

Material restrictions

This HP product contains the following materials that might require special handling at end-of-life: coin cell battery.

This product's real-time clock battery or coin cell battery may contain perchlorate and may require special handling when recycled or disposed of in California. (See www.dtsc.ca.gov/hazardouswaste/perchlorate.) The batteries contained in or supplied by Hewlett-Packard for this product include the following:

HP Digital Sender Flow 8500 fn1	
Type	Lithium carbon monofluoride
Weight	2.4 g
Location	On formatter
User-removable	No



廢電池請回收

For recycling information, you can go to www.hp.com/recycle, or contact your local authorities or the Electronics Industries Alliance: www.eiae.org.

Disposal of waste equipment by users in private households in the European Union



This symbol on the product or on its packaging indicates that this product must not be disposed of with your other household waste. Instead, it is your responsibility to dispose of your waste equipment by handing it over to a designated collection point for the recycling of waste electrical and electronic equipment. The separate collection and recycling of your waste equipment at the time of disposal will help to conserve natural resources and ensure that it is recycled in a manner that protects human health and the environment. For more information about where you can drop off your waste equipment for recycling, please contact your local city office, your household waste disposal service or the shop where you purchased the product.

Chemical substances

HP is committed to providing our customers with information about the chemical substances in our products as needed to comply with legal requirements such as REACH (Regulation EC No 1907/2006 of the European Parliament and the Council). A chemical information report for this product can be found at: www.hp.com/go/reach.

For more information

To obtain information about these environmental topics:

- Product environmental profile sheet for this and many related HP products
- HP's commitment to the environment
- HP's environmental management system
- HP's end-of-life product return and recycling program
- Material Safety Data Sheets

Visit www.hp.com/go/environment or www.hp.com/hpinfo/globalcitizenship/environment.

Hewlett-Packard limited warranty statement

HP Digital Sender Flow 8500 fn1 Document Capture Workstation

Model	Asia/Pacific	Americas	Europe/Middle East/ Africa
8500 fn1	1 year	1 year	1 year

1. HP warrants to you, the end-user customer, that HP hardware, accessories, and supplies will be free from defects in materials and workmanship after the date of purchase, for the period specified above. If HP receives notice of such defects during the warranty period, HP will, at its option, either replace or repair products which prove to be defective. Replacement products may be either new or equivalent in performance to new.

2. HP warrants to you that HP software will not fail to execute its programming instructions after the date of purchase, for the period specified above, due to defects in material and workmanship when properly installed and used. If HP receives notice of such defects during the warranty period, HP will replace software which does not execute its programming instructions due to such defects.

3. HP does not warrant that the operation of HP products will be uninterrupted or error free. If HP is unable, within a reasonable time, to repair or replace any product to a condition as warranted, you will be entitled to a refund of the purchase price upon prompt return of the product.

4. HP products may contain remanufactured parts equivalent to new in performance or may have been subject to incidental use.

5. This warranty does not apply to defects resulting from (a) improper or inadequate maintenance or calibration, (b) software, interfacing, parts, or supplies not supplied by HP, (c) unauthorized

modification or misuse, (d) operation outside of the published environmental specifications for the product, or (e) improper site preparation or maintenance.

6. TO THE EXTENT ALLOWED BY LOCAL LAW, THE ABOVE WARRANTIES ARE EXCLUSIVE AND NO OTHER WARRANTY OR CONDITION, WHETHER WRITTEN OR ORAL, IS EXPRESSED OR IMPLIED, AND HP SPECIFICALLY DISCLAIMS ANY IMPLIED WARRANTIES OR CONDITIONS OF MERCHANTABILITY, SATISFACTORY QUALITY, AND FITNESS FOR A PARTICULAR PURPOSE. Some countries/regions, states, or provinces do not allow limitations on the duration of an implied warranty, so the above limitation or exclusion might not apply to you. This warranty gives you specific legal rights, and you might also have other rights that vary from country/region to country/region, state to state, or province to province.

7. HP's limited warranty is valid in any country/region or locality where HP has a support presence for this product and where HP has marketed this product. The level of warranty service you receive may vary according to local standards. HP will not alter the form, fit, or function of the product to make it operate in a country/region in which it was never intended to function for legal or regulatory reasons.

8. TO THE EXTENT ALLOWED BY LOCAL LAW, THE REMEDIES IN THIS WARRANTY STATEMENT ARE YOUR SOLE AND EXCLUSIVE REMEDIES. EXCEPT AS INDICATED ABOVE, IN NO EVENT WILL HP OR ITS SUPPLIERS BE LIABLE FOR LOSS OF DATA OR FOR DIRECT, SPECIAL, INCIDENTAL, CONSEQUENTIAL (INCLUDING LOST PROFIT OR DATA), OR OTHER DAMAGE, WHETHER BASED IN CONTRACT, TORT, OR OTHERWISE. Some countries/regions, states, or provinces do not allow the exclusion or limitation of incidental or consequential damages, so the above limitation or exclusion may not apply to you.

9. THE WARRANTY TERMS CONTAINED IN THIS STATEMENT, EXCEPT TO THE EXTENT LAWFULLY PERMITTED, DO NOT EXCLUDE, RESTRICT, OR MODIFY AND ARE IN ADDITION TO THE MANDATORY STATUTORY RIGHTS APPLICABLE TO THE SALE OF THIS PRODUCT TO YOU.

Index

A

- address books, e-mail
 - adding addresses 52
 - auto-complete function 55
 - importing 35
 - LDAP support 16
 - recipient lists 52
 - recipient lists, creating 52
- ADF
 - capacity 1
 - clean duplex background 59
 - load paper 43
- Administration menu, control panel 16
- administrator password 27
- Attention light
 - locating 7
- authentication and authorization 39
- auto-shutdown 5

B

- batteries included 96
- bins
 - locating 3
- blank page suppression 1
- browser requirements
 - Embedded Web Server 34
- buttons, control panel
 - locating 7
 - touch screen 11

C

- capacity
 - ADF 1
- Certificate of Volatility
 - hard disk drive memory 95
 - non-volatile memory 94
 - volatile memory 94
- certificate revocation list 39
- clean
 - ADF 59
 - rollers 62
 - scanning glass 59

- scanning strip 59
- touch screen 59
- configure
 - network folders 28
 - Quick Sets 30
 - save to SharePoint 29
 - USB storage device 29
- configure the product
 - using Administration menu 16
 - using the Embedded Web Server 27, 31
- connectivity 1
- connectivity features 2
- control panel
 - Administration menu 16
 - buttons 7
 - clean touch screen 59
 - e-mail screen 53
 - fax screen 55
 - help 11
 - Home screen 10
 - layout 7
 - lights 7
 - locating 3
 - security 35
 - touch screen buttons 11
- covers, locating 3
- CRL 39
- customer support 92
- cut-off images
 - troubleshoot 88

D

- Data light
 - locating 7
- default gateway, setting 25
- device discovery 14
- digital sending
 - about 52
 - address books 52
 - control-panel settings 53, 55
 - Embedded Web Server
 - settings 35
 - folders 56
 - LDAP support 16

- recipient lists 52
- sending documents 54
- SMTP support 16
- USB storage device 56
- validating gateway addresses 90
- workflow 57
- disabling
 - network protocols 26
- disposal, end-of-life 96
- document feeder
 - load paper 45
 - tips on loading 43
- documents
 - tips for mixed-size documents 44

E

- e-mail address books
 - deleting addresses 53
- Embedded Web Server 13
 - assigning a password 36
 - features 34
 - General tab 35
 - Information tab 35
 - Networking tab 35
 - options 34
 - Scan/Digital Send tab 35
 - Security tab 35
- end-of-life disposal 96
- environmental features 1
- Environmental Product Stewardship Program 95
- environmental specifications 94
- Error button, control panel touch screen 11
- error messages
 - control panel 9
- Ethernet cards 2
- European Union, waste disposal 96
- EWS
 - features 34
 - General tab 35
 - Information tab 35

- Networking tab 35
- options 34
- Scan/Digital Send tab 35
- Security tab 35
- Explorer, versions supported
 - Embedded Web Server 34
- e-mail
 - about 52
 - address books 52
 - auto-complete function 55
 - control-panel settings 53
 - Embedded Web Server settings 35
 - LDAP support 16
 - problem solving 90
 - recipient lists 52
 - security 35
 - sending documents 54
 - SMTP support 16
 - validating gateway addresses 90

F

- factory settings, restore 92
- fax, settings 55
- features 1
- features, new 49
 - automatic tone 49
 - automatically straighten 49
 - cropping options 49
 - erase edges 49
 - job build 50
 - scan to SharePoint site 50
 - send document to network printer 50
- feed rollers
 - replace 65
- feeding problems 87
- firmware, upgrading 40
- folders
 - sending to 56
- fragile items, scanning 87
- front panel
 - replace 72
- FTP, sending to 57

G

- gateway, setting default 25
- gateways
 - validating addresses 90

- General tab, Embedded Web Server 35
- glass, clean 59
- graphical display, control panel 7

H

- hard disks 38
- hard drive, replace 76
- hardware integration pocket 80
- Help button, control panel touch screen 11
- help, control panel 11
- Home button, control panel touch screen 11
- Home screen, control panel 10
- HP Digital Sending Software (HP DSS) 14
- HP Jetdirect server settings 17
- HP Web Jetadmin 13, 35
- humidity specifications 94

I

- Image Preview 50
 - use 51
- information pages 33
- Information tab, Embedded Web Server 35
- install a Jetdirect card 79
- install components 65
- installation
 - troubleshoot 85
- interface ports
 - included 2
- Internet Explorer, versions supported
 - Embedded Web Server 34
- IP address 25, 26
- IP addressing 15

J

- jams
 - troubleshoot 88
- Jetadmin, HP Web 13, 35
- Jetdirect card, install 79
- Jetdirect server settings 17

K

- keyboard 74

- keys, control panel
 - locating 7
 - touch screen 11

L

- LAN-connector 2
- LDAP servers
 - connect to 16
 - Embedded Web Server settings 35
 - validating gateway addresses 90
- lights
 - control panel 7
- link speed settings 23
- loading documents
 - tips for mixed-size documents 44
- log in 49

M

- maintain the product 59
- maintenance
 - clean rollers 62
- manage
 - EWS 34
- manage temporary job files 37
- managing network 27
- material restrictions 96
- media
 - jams 88
 - misfeeds 87
 - not feeding 87
 - troubleshoot 87
- memory 1
- memory, hard drive 95
- Menu button 7
- menus, control panel
 - Administration 16
- mercury product 96
- misfeeds
 - troubleshoot 87
- multiple-page feeds 87

N

- Netscape Navigator, versions supported
 - Embedded Web Server 34
- network
 - settings, changing 27
 - settings, viewing 27

- network folders
 - configure 28
 - scan to 56
- Networking tab, Embedded Web Server 35
- networks
 - configuring 13
 - connectivity features 2
 - default gateway 25
 - device discovery 14
 - disabling protocols 26
 - HP Web Jetadmin 35
 - IP address 15, 25, 26
 - link speed settings 23
 - protocols supported 14
 - SMTP servers 16
 - subnet mask 25
 - TCP/IP settings 17
 - validating gateway addresses 90
- new features 49
 - automatic tone 49
 - automatically straighten 49
 - cropping options 49
 - erase edges 49
 - job build 50
 - scan to SharePoint site 50
 - send document to network printer 50

- O**
 - on/off switch, locating 3
 - online help, control panel 11
 - operating environment
 - specifications 94
 - order
 - roller replacement kit 65
 - supplies 59
 - output bin
 - locating 3

- P**
 - paper
 - jams 88
 - misfeeds 87
 - not feeding 87
 - troubleshoot 87
 - paper feeding problems 87
 - paper-handling 1

- parts
 - order 65, 74
- password 27
- passwords 35
- ports
 - included 2
- power switch, locating 3
- preview scan 50
- problem-solving
 - Error button, control panel touch screen 11
 - e-mail 90
- product
 - auto-shutdown 5
 - reset 86
 - Sleep Mode 4
 - specifications 93
- product info 1
- product maintenance 59
- product, configure
 - using Administration menu 16
 - using the Embedded Web Server 27, 31
- protocols, network 14

- Q**
 - Quick Sets 57
 - configure 30

- R**
 - Ready light
 - locating 7
 - recipient lists 52
 - regulatory statements
 - environmental product stewardship program 95
 - replace
 - front panel 72
 - rollers 65
 - separation pad 68
 - replace and install components 65
 - replace keyboard 74
 - replace the hard drive 76
 - Reset button 7
 - reset product 86
 - resolution 1
 - restore factory settings 92

- rollers
 - clean 62
 - replace 65

- S**
 - Save to Folder 56
 - Save to Network Folder Setup 28
 - Save to SharePoint 29
 - save to SharePoint
 - configure 29
 - Save to USB 56
 - scan
 - feeding problems 87
 - fragile items 87
 - paper originals 45
 - preview 50
 - to e-mail 52
 - to fax 56
 - to network folder 56
 - to USB 56
 - using Quick Sets 57
 - Scan/Digital Send tab, Embedded Web Server 35
 - scanning
 - features 3
 - scanning glass
 - load original 46
 - scanning strip, clean 59
 - scanning to e-mail
 - about 52
 - address books 52
 - control-panel settings 53
 - Embedded Web Server
 - settings 35
 - LDAP support 16
 - recipient lists 52
 - sending documents 54
 - SMTP support 16
 - validating addresses 90
 - scanning to folder 56
 - scanning to workflow 57
 - Secure Disk Erase 38
 - Secure Storage Erase 37
 - security 35, 36
 - authentication and authorization 39
 - certificates 38
 - Embedded Web Server
 - settings 35
 - encrypted hard disk 38

